

IBM XL Fortran for AIX, V15.1.3



# Optimization and Programming Guide

*Version 15.1.3*



IBM XL Fortran for AIX, V15.1.3



# Optimization and Programming Guide

*Version 15.1.3*

**Note**

Before using this information and the product it supports, read the information in "Notices" on page 339.

**First edition**

This edition applies to IBM XL Fortran for AIX, V15.1.3 (Program 5765-J09; 5725-C74) and to all subsequent releases and modifications until otherwise indicated in new editions. Make sure you are using the correct edition for the level of the product.

© Copyright IBM Corporation 1990, 2015.

US Government Users Restricted Rights – Use, duplication or disclosure restricted by GSA ADP Schedule Contract with IBM Corp.

---

# Contents

## About this document . . . . . vii

Who should read this document . . . . .	vii
How to use this document . . . . .	vii
How this document is organized . . . . .	vii
Conventions . . . . .	viii
Related information . . . . .	xii
IBM XL Fortran information . . . . .	xii
Standards and specifications . . . . .	xiii
Other IBM information . . . . .	xiv
Technical support . . . . .	xiv
How to send your comments . . . . .	xiv

## Chapter 1. Optimizing your applications 1

Distinguishing between optimization and tuning . . . . .	1
Steps in the optimization process . . . . .	2
Basic optimization . . . . .	2
Optimizing at level 0 . . . . .	3
Optimizing at level 2 . . . . .	3
Advanced optimization . . . . .	4
Optimizing at level 3 . . . . .	5
An intermediate step: adding <b>-qhot</b> suboptions at level 3 . . . . .	6
Optimizing at level 4 . . . . .	7
Optimizing at level 5 . . . . .	8
Specialized optimization techniques . . . . .	8
High-order transformation (HOT) . . . . .	9
Interprocedural analysis (IPA) . . . . .	11
Profile-directed feedback . . . . .	15
Handling table of contents (TOC) overflow . . . . .	23
Vector technology . . . . .	26
Using compiler reports to diagnose optimization opportunities . . . . .	30
Tracing procedures in your code . . . . .	32
Getting more performance . . . . .	37
Beyond performance: effective programming techniques . . . . .	37

## Chapter 2. Tuning XL compiler applications . . . . . 39

Tuning for your target architecture . . . . .	39
Using <b>-qarch</b> . . . . .	40
Using <b>-qtune</b> . . . . .	42
Using <b>-qcache</b> . . . . .	42
Before you finish tuning . . . . .	43
Further option driven tuning . . . . .	43
Options for providing application characteristics . . . . .	43
Options to control optimization transformations . . . . .	46
Options to assist with performance analysis . . . . .	47
Options that can inhibit performance . . . . .	48

## Chapter 3. Advanced optimization concepts . . . . . 49

Aliasing . . . . .	49
Inlining . . . . .	49

Finding the right level of inlining . . . . .	50
---	----

## Chapter 4. Managing code size . . . . . 53

Steps for reducing code size . . . . .	54
Compiler option influences on code size . . . . .	54
The <b>-qipa</b> compiler option . . . . .	54
The <b>-qinline</b> inlining option . . . . .	54
The <b>-qhot</b> compiler option . . . . .	55
The <b>-qcompact</b> compiler option . . . . .	55
Other influences on code size . . . . .	55
High activity areas . . . . .	55
Computed GOTOs and CASE constructs . . . . .	56
Code size with dynamic or static linking . . . . .	56

## Chapter 5. Debugging optimized code 59

Understanding different results in optimized programs . . . . .	60
Debugging in the presence of optimization . . . . .	60
Using <b>-qoptdebug</b> to help debug optimized programs . . . . .	62

## Chapter 6. Compiler-friendly programming techniques . . . . . 65

General practices . . . . .	65
Variables and pointers . . . . .	65
Arrays . . . . .	66
Choosing appropriate variable sizes . . . . .	66
Submodules (Fortran 2008) . . . . .	67

## Chapter 7. High performance libraries 71

Using the Mathematical Acceleration Subsystem (MASS) libraries . . . . .	71
Using the scalar library . . . . .	72
Using the vector libraries . . . . .	74
Using the SIMD libraries . . . . .	79
Compiling and linking a program with MASS . . . . .	84
Using the Basic Linear Algebra Subprograms – BLAS . . . . .	85
BLAS function syntax . . . . .	85
Linking the <b>libxlopt</b> library . . . . .	88

## Chapter 8. Parallel programming with XL Fortran . . . . . 89

Compiling your parallelized code . . . . .	89
The <b>_OPENMP</b> C preprocessor macro and conditional compilation . . . . .	89
Setting runtime options . . . . .	90
<b>XLSMPOPTS</b> . . . . .	90
Environment variables for OpenMP . . . . .	97
Optimizing your SMP code . . . . .	104
Developing and running SMP applications . . . . .	104
An introduction to parallelization directives . . . . .	105
Parallel region construct . . . . .	105
Work-sharing constructs . . . . .	105

Combined parallel work-sharing constructs . . . . .	106	omp_get_thread_limit() . . . . .	192
Synchronization constructs . . . . .	106	omp_get_thread_num() . . . . .	193
Other OpenMP directives . . . . .	106	omp_get_wtick() . . . . .	194
Non-OpenMP SMP directives . . . . .	106	omp_get_wtime() . . . . .	194
Deprecated directive . . . . .	106	omp_in_final() . . . . .	195
Detailed descriptions of parallelization directives	107	omp_in_parallel() . . . . .	195
ATOMIC . . . . .	107	omp_init_lock(svar) . . . . .	196
BARRIER . . . . .	113	omp_init_nest_lock(nvar) . . . . .	197
CRITICAL / END CRITICAL . . . . .	114	omp_set_dynamic(enable_expr) . . . . .	198
DO / END DO . . . . .	116	omp_set_lock(svar) . . . . .	199
DO SERIAL . . . . .	119	omp_set_max_active_levels(max_levels) . . . . .	200
FLUSH . . . . .	120	omp_set_nested(enable_expr) . . . . .	200
MASTER / END MASTER . . . . .	122	omp_set_nest_lock(nvar) . . . . .	201
ORDERED / END ORDERED . . . . .	124	omp_set_num_threads(number_of_threads_expr) . . . . .	202
PARALLEL / END PARALLEL . . . . .	126	omp_set_schedule(kind, modifier) . . . . .	202
PARALLEL DO / END PARALLEL DO . . . . .	128	omp_test_lock(svar) . . . . .	203
PARALLEL SECTIONS / END PARALLEL SECTIONS . . . . .	132	omp_test_nest_lock(nvar) . . . . .	204
PARALLEL WORKSHARE / END PARALLEL WORKSHARE . . . . .	134	omp_unset_lock(svar) . . . . .	205
SCHEDULE . . . . .	135	omp_unset_nest_lock(nvar) . . . . .	205
SECTIONS / END SECTIONS . . . . .	138	Pthreads Library Module . . . . .	206
SINGLE / END SINGLE . . . . .	141	Pthreads data structures, functions, and	
TASK / END TASK . . . . .	145	subroutines . . . . .	207
TASKWAIT . . . . .	147	f_maketime(delay) . . . . .	210
TASKYIELD . . . . .	147	f_pthread_attr_destroy(attr) . . . . .	210
THREADLOCAL . . . . .	148	f_pthread_attr_getdetachstate(attr, detach) . . . . .	211
THREADPRIVATE . . . . .	150	f_pthread_attr_getguardsize(attr, guardsize) . . . . .	211
WORKSHARE / END WORKSHARE . . . . .	156	f_pthread_attr_getinheritsched(attr, inherit) . . . . .	212
Data sharing attribute rules . . . . .	158	f_pthread_attr_getschedparam(attr, param) . . . . .	213
Directive clauses . . . . .	160	f_pthread_attr_getschedpolicy(attr, policy) . . . . .	213
COLLAPSE . . . . .	161	f_pthread_attr_getscope(attr, scope) . . . . .	214
COPYIN . . . . .	163	f_pthread_attr_getstackaddr(attr, stackaddr) . . . . .	215
COPYPRIVATE . . . . .	165	f_pthread_attr_getstacksize(attr, ssize) . . . . .	215
DEFAULT . . . . .	166	f_pthread_attr_init(attr) . . . . .	216
FINAL . . . . .	168	f_pthread_attr_setdetachstate(attr, detach) . . . . .	216
FIRSTPRIVATE . . . . .	168	f_pthread_attr_setguardsize(attr, guardsize) . . . . .	217
IF . . . . .	169	f_pthread_attr_setinheritsched(attr, inherit) . . . . .	218
LASTPRIVATE . . . . .	170	f_pthread_attr_setschedparam(attr, param) . . . . .	219
MERGEABLE . . . . .	172	f_pthread_attr_setschedpolicy(attr, policy) . . . . .	219
NUM_THREADS . . . . .	173	f_pthread_attr_setscope(attr, scope) . . . . .	220
ORDERED . . . . .	173	f_pthread_attr_setstackaddr(attr, stackaddr) . . . . .	221
PRIVATE . . . . .	174	f_pthread_attr_setstacksize(attr, ssize) . . . . .	221
REDUCTION . . . . .	176	f_pthread_attr_t . . . . .	222
SCHEDULE . . . . .	179	f_pthread_cancel(thread) . . . . .	222
SHARED . . . . .	182	f_pthread_cleanup_pop(exec) . . . . .	223
UNTIED . . . . .	183	f_pthread_cleanup_push(cleanup, flag, arg) . . . . .	223
Routines for OpenMP . . . . .	184	f_pthread_cond_broadcast(cond) . . . . .	225
omp_destroy_lock(svar) . . . . .	185	f_pthread_cond_destroy(cond) . . . . .	225
omp_destroy_nest_lock(nvar) . . . . .	186	f_pthread_cond_init(cond, cattr) . . . . .	226
omp_get_active_level() . . . . .	187	f_pthread_cond_signal(cond) . . . . .	226
omp_get_ancestor_thread_num(level) . . . . .	187	f_pthread_cond_t . . . . .	227
omp_get_dynamic() . . . . .	187	f_pthread_cond_timedwait(cond, mutex,	
omp_get_level() . . . . .	188	timeout) . . . . .	227
omp_get_max_active_levels() . . . . .	188	f_pthread_cond_wait(cond, mutex) . . . . .	228
omp_get_max_threads() . . . . .	189	f_pthread_condattr_destroy(cattr) . . . . .	228
omp_get_nested() . . . . .	189	f_pthread_condattr_getpshared(cattr, pshared) . . . . .	229
omp_get_num_procs() . . . . .	190	f_pthread_condattr_init(cattr) . . . . .	230
omp_get_num_threads() . . . . .	190	f_pthread_condattr_setpshared(cattr, pshared) . . . . .	230
omp_get_schedule(kind, modifier) . . . . .	191	f_pthread_condattr_t . . . . .	231
omp_get_team_size(level) . . . . .	192	f_pthread_create(thread, attr, flag, ent, arg) . . . . .	231
		f_pthread_detach(thread) . . . . .	233
		f_pthread_equal(thread1, thread2) . . . . .	233

<code>f_thread_exit(ret)</code>	234
<code>f_thread_getconcurrency()</code>	234
<code>f_thread_getschedparam(thread, policy, param)</code>	235
<code>f_thread_getspecific(key, arg)</code>	235
<code>f_thread_join(thread, ret)</code>	236
<code>f_thread_key_create(key, dtr)</code>	237
<code>f_thread_key_delete(key)</code>	237
<code>f_thread_key_t</code>	238
<code>f_thread_kill(thread, sig)</code>	238
<code>f_thread_mutex_destroy(mutex)</code>	239
<code>f_thread_mutex_getprioceiling(mutex, old)</code>	239
<code>f_thread_mutex_init(mutex, mattr)</code>	240
<code>f_thread_mutex_lock(mutex)</code>	241
<code>f_thread_mutex_setprioceiling(mutex, new, old)</code>	241
<code>f_thread_mutex_t</code>	242
<code>f_thread_mutex_trylock(mutex)</code>	242
<code>f_thread_mutex_unlock(mutex)</code>	243
<code>f_thread_mutexattr_destroy(mattr)</code>	243
<code>f_thread_mutexattr_getprioceiling(mattr, ceiling)</code>	244
<code>f_thread_mutexattr_getprotocol(mattr, proto)</code>	244
<code>f_thread_mutexattr_getpshared(mattr, pshared)</code>	245
<code>f_thread_mutexattr_gettype(mattr, type)</code>	245
<code>f_thread_mutexattr_init(mattr)</code>	246
<code>f_thread_mutexattr_setprioceiling(mattr, ceiling)</code>	247
<code>f_thread_mutexattr_setprotocol(mattr, proto)</code>	247
<code>f_thread_mutexattr_setpshared(mattr, pshared)</code>	248
<code>f_thread_mutexattr_settype(mattr, type)</code>	249
<code>f_thread_mutexattr_t</code>	250
<code>f_thread_once(once, initr)</code>	250
<code>f_thread_once_t</code>	250
<code>f_thread_rwlock_destroy(rwlock)</code>	251
<code>f_thread_rwlock_init(rwlock, rwattr)</code>	251
<code>f_thread_rwlock_rdlock(rwlock)</code>	252
<code>f_thread_rwlock_t</code>	253
<code>f_thread_rwlock_tryrdlock(rwlock)</code>	253
<code>f_thread_rwlock_trywrlock(rwlock)</code>	254
<code>f_thread_rwlock_unlock(rwlock)</code>	254
<code>f_thread_rwlock_wrlock(rwlock)</code>	255
<code>f_thread_rwlockattr_destroy(rwattr)</code>	256
<code>f_thread_rwlockattr_getpshared(rwattr, pshared)</code>	256
<code>f_thread_rwlockattr_init(rwattr)</code>	257
<code>f_thread_rwlockattr_setpshared(rwattr, pshared)</code>	257
<code>f_thread_rwlockattr_t</code>	258
<code>f_thread_self()</code>	258
<code>f_thread_setcancelstate(state, oldstate)</code>	259
<code>f_thread_setcanceltype(type, oldtype)</code>	259
<code>f_thread_setconcurrency(new_level)</code>	260
<code>f_thread_setschedparam(thread, policy, param)</code>	261
<code>f_thread_setspecific(key, arg)</code>	262
<code>f_thread_t</code>	262
<code>f_thread_testcancel()</code>	263
<code>f_sched_param</code>	263
<code>f_sched_yield()</code>	263
<code>f_timespec</code>	264

## Chapter 9. Interlanguage calls . . . . 265

Conventions for XL Fortran external names	265
---	-----

Mixed-language input and output	266
Mixing Fortran and C++	267
Making calls to C functions work	268
Passing data from one language to another	269
Passing arguments between languages	269
Passing global variables between languages	270
Passing character types between languages	271
Passing arrays between languages	272
Passing pointers between languages	273
Passing arguments by reference or by value	273
Returning values from Fortran functions	275
Arguments with the OPTIONAL attribute	275
Type encoding and checking	276
Assembler-level subroutine linkage conventions	276
The stack	278
The Linkage Area	281
The input parameter area	282
The register save area	282
The local stack area	283
The output parameter area	283
Linkage convention for argument passing	283
Argument passing rules (by value)	284
Order of arguments in argument list	287
Linkage convention for function calls	287
Pointers to functions	287
Function values	288
The stack floor	288
Stack overflow	289
Prolog and epilog	289
Traceback	289

## Chapter 10. Implementation details of XL Fortran Input/Output (I/O). . . . . 291

Implementation details of file formats	291
File names	292
Preconnected and Implicitly Connected Files	293
File positioning	294
Preserving the XL Fortran Version 2.3 file positioning	294
I/O redirection	295
How XL Fortran I/O interacts with pipes, special files, and links	295
Default record lengths	296
File permissions	296
Selecting error messages and recovery actions	296
Flushing I/O buffers	297
Choosing locations and names for Input/Output files	298
Naming files that are connected with no explicit name	298
Naming scratch files	298
Increasing throughput with logical volume I/O and data striping	299
Logical volume I/O	299
Data striping	300
Asynchronous I/O	300
Execution of an asynchronous data transfer operation	301
Usage	301
Performance	303
Compiler-generated temporary I/O items	304

System setup . . . . .	305
Linking . . . . .	305
Error handling . . . . .	306
XL Fortran thread-safe I/O library . . . . .	306
Synchronization of I/O operations . . . . .	306
Parallel I/O issues. . . . .	307
Use of I/O statements in signal handlers . . . . .	309
Asynchronous thread cancellation . . . . .	309

## Chapter 11. Implementation details of XL Fortran floating-point processing . 311

IEEE floating-point overview . . . . .	311
Compiling for strict IEEE conformance . . . . .	311
IEEE single-precision and double-precision values . . . . .	312
IEEE extended-precision values . . . . .	312
Infinities and NaNs . . . . .	312
Exception-handling model . . . . .	313
Hardware-specific floating-point overview. . . . .	314
Single-precision and double-precision values . . . . .	314
Extended-precision values . . . . .	315
How XL Fortran rounds floating-point calculations . . . . .	316
Selecting the rounding mode . . . . .	316
Minimizing rounding errors . . . . .	318
Minimizing overall rounding . . . . .	318
Delaying rounding until run time . . . . .	318
Ensuring that the rounding mode is consistent . . . . .	319
Duplicating the floating-point results of other systems . . . . .	319
Maximizing floating-point performance . . . . .	320
Detecting and trapping floating-point exceptions . . . . .	321
Compiler features for trapping floating-point exceptions . . . . .	321
Operating system features for trapping floating-point exceptions . . . . .	322
Installing an exception handler . . . . .	323
Producing a core file . . . . .	324

Controlling the floating-point status and control register . . . . .	324
xlf_fp_util procedures . . . . .	325
fpgets and fpsets subroutines . . . . .	325
Sample programs for exception handling . . . . .	326
Causing exceptions for particular variables . . . . .	327
Minimizing the performance impact of floating-point exception trapping . . . . .	327

## Chapter 12. Porting programs to XL Fortran . . . . . 329

Outline of the porting process . . . . .	329
Maintaining FORTRAN 77 source and object code . . . . .	329
Portability of directives . . . . .	330
Common industry extensions that XL Fortran supports . . . . .	331
Mixing data types in statements . . . . .	332
Date and time routines . . . . .	332
Other libc routines . . . . .	332
Changing the default sizes of data types . . . . .	332
Name conflicts between your procedures and XL Fortran intrinsic procedures . . . . .	332
Reproducing results from other systems . . . . .	332

## Chapter 13. Sample Fortran programs 333

Example 1 - XL Fortran source file . . . . .	333
Example 2 - valid C routine source file . . . . .	333
Example 3 - valid Fortran SMP source file. . . . .	336
Example 4 - invalid Fortran SMP source file . . . . .	336
Programming examples using the Pthreads library module . . . . .	337

## Notices . . . . . 339

Trademarks . . . . .	341
----------------------	-----

## Index . . . . . 343



---

## About this document

This document is part of the IBM® XL Fortran for AIX®, V15.1.3 information suite. It provides both reference information and practical tips for using the optimization and tuning capabilities of XL Fortran to maximize application performance, as well as expanding on programming concepts such as I/O and interlanguage calls.

---

## Who should read this document

This document is for anyone who wants to exploit the capabilities of XL Fortran for optimizing and tuning Fortran programs. Readers should be familiar with their AIX operating system and have extensive Fortran programming experience with complex applications. However, users new to XL Fortran can still use this information to help them understand how the compiler's features can be used for effective program optimization.

---

## How to use this document

This guide focuses on specific programming and compilation techniques that can maximize XL Fortran application performance. It covers optimization and tuning strategies, recommended programming practices, and compilation procedures, debugging, and information about using XL Fortran advanced language features. This guide also contains cross-references to relevant topics of other reference guides in the XL Fortran information suite.

Topics not described in this information are available as follows:

- Installation, system requirements, last-minute updates: see the *XL Fortran Installation Guide* and product README file.
- Overview of XL Fortran features: see the *Getting Started with XL Fortran* book.
- Syntax, semantics, and implementation of the XL Fortran programming language: see the *XL Fortran Language Reference* book.
- Compiler setup, compiling and running programs, compiler options, diagnostics: see the *XL Fortran Compiler Reference* book.
- Operating system commands related to the use of the compiler: *AIX Commands Reference, Volumes 1 - 6* and the information center for AIX operating systems.

---

## How this document is organized

This guide includes the following topics:

- Chapter 1, "Optimizing your applications," on page 1 provides an overview of the optimization process.
- Chapter 2, "Tuning XL compiler applications," on page 39 discusses the compiler options available for optimizing and tuning code.
- Chapter 3, "Advanced optimization concepts," on page 49, Chapter 4, "Managing code size," on page 53, and Chapter 5, "Debugging optimized code," on page 59 discuss advanced techniques, such as optimizing loops and inlining code, and debug considerations for optimized code.

- The following sections contain information about how to write optimization friendly and portable XL Fortran code that is interoperable with other languages. Also included is a description of XL Fortran support for OpenMP and SMP with guidelines for writing parallel code.
  - Chapter 6, “Compiler-friendly programming techniques,” on page 65
  - Chapter 7, “High performance libraries,” on page 71
  - Chapter 8, “Parallel programming with XL Fortran,” on page 89
  - Chapter 9, “Interlanguage calls,” on page 265
- The following sections contain information about XL Fortran and its implementation that can be useful for new and experienced users alike, as well as those who want to move their existing Fortran applications to the XL Fortran compiler:
  - Chapter 10, “Implementation details of XL Fortran Input/Output (I/O),” on page 291
  - Chapter 11, “Implementation details of XL Fortran floating-point processing,” on page 311
  - Chapter 12, “Porting programs to XL Fortran,” on page 329
- Chapter 13, “Sample Fortran programs,” on page 333 provides coding examples for XL Fortran.

---

## Conventions

### Typographical conventions

The following table shows the typographical conventions used in the IBM XL Fortran for AIX, V15.1.3 information.









Table 1. Typographical conventions

Typeface	Indicates	Example
<b>lowercase bold</b>	Invocation commands, executable names, and compiler options.	The compiler provides basic invocation commands, <b>xlf</b> , along with several other compiler invocation commands to support various Fortran language levels and compilation environments.  The default file name for the executable program is <b>a.out</b> .
<i>italics</i>	Parameters or variables whose actual names or values are to be supplied by the user. Italics are also used to introduce new terms.	Make sure that you update the <i>size</i> parameter if you return more than the <i>size</i> requested.
<u>underlining</u>	The default setting of a parameter of a compiler option or directive.	nomaf   <u>maf</u>
monospace	Examples of program code, reference to program code, file names, path names, command strings, or user-defined names.	To compile and optimize myprogram.f, enter: xlf myprogram.f -03.
<b>UPPERCASE bold</b>	Fortran programming keywords, statements, directives, and intrinsic procedures. Uppercase letters may also be used to indicate the minimum number of characters required to invoke a compiler option/suboption.	The <b>ASSERT</b> directive applies only to the <b>DO</b> loop immediately following the directive, and not to any nested <b>DO</b> loops.

## Qualifying elements (icons and bracket separators)

In descriptions of language elements, this information uses icons and marked bracket separators to delineate the Fortran language standard text as follows:







Table 2. Qualifying elements

Icon	Bracket separator text	Meaning
 	Fortran 2008 begins / Fortran 2008 ends	The text describes an IBM XL Fortran implementation of the Fortran 2008 standard.
 	Fortran 2003 begins / Fortran 2003 ends	The text describes an IBM XL Fortran implementation of the Fortran 2003 standard, and it applies to all later standards.
 	IBM extension begins / IBM extension ends	The text describes a feature that is an IBM XL Fortran extension to the standard language specifications.
 	TS 29113 begins / TS 29113 ends	The text describes an IBM XL Fortran implementation of Technical Specification 29113, referred to as TS 29113.

**Note:** If the information is marked with a Fortran language standard icon or bracket separators, it applies to this specific Fortran language standard and all later ones. If it is not marked, it applies to all Fortran language standards.

## Syntax diagrams

Throughout this information, diagrams illustrate XL Fortran syntax. This section helps you to interpret and use those diagrams.

- Read the syntax diagrams from left to right, from top to bottom, following the path of the line.
  - The  symbol indicates the beginning of a command, directive, or statement.
  - The  symbol indicates that the command, directive, or statement syntax is continued on the next line.
  - The  symbol indicates that a command, directive, or statement is continued from the previous line.
  - The  symbol indicates the end of a command, directive, or statement.
- Fragments, which are diagrams of syntactical units other than complete commands, directives, or statements, start with the  symbol and end with the  symbol.
- IBM XL Fortran extensions are marked by a number in the syntax diagram with an explanatory note immediately following the diagram.
- Program units, procedures, constructs, interface blocks and derived-type definitions consist of several individual statements. For such items, a box encloses the syntax representation, and individual syntax diagrams show the required order for the equivalent Fortran statements.
- Required items are shown on the horizontal line (the main path):

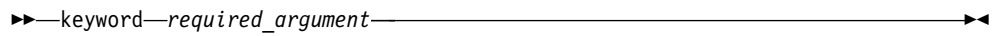

- Optional items are shown below the main path:



**Note:** Optional items (not in syntax diagrams) are enclosed by square brackets ([ and ]). For example, [UNIT=]u

- If you can choose from two or more items, they are shown vertically, in a stack. If you *must* choose one of the items, one item of the stack is shown on the main path.



If choosing one of the items is optional, the entire stack is shown below the main path.



- An arrow returning to the left above the main line (a repeat arrow) indicates that you can make more than one choice from the stacked items or repeat an item. The separator character, if it is other than a blank, is also indicated:



- The item that is the default is shown above the main path.

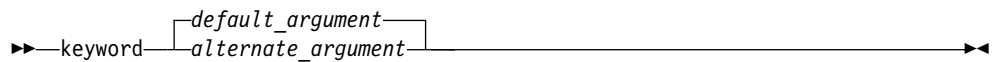

- Keywords are shown in nonitalic letters and should be entered exactly as shown.
- Variables are shown in italicized lowercase letters. They represent user-supplied names or values. If a variable or user-specified name ends in *\_list*, you can provide a list of these terms separated by commas.
- If punctuation marks, parentheses, arithmetic operators, or other such symbols are shown, you must enter them as part of the syntax.

### Sample syntax diagram

The following is an example of a syntax diagram with an interpretation:

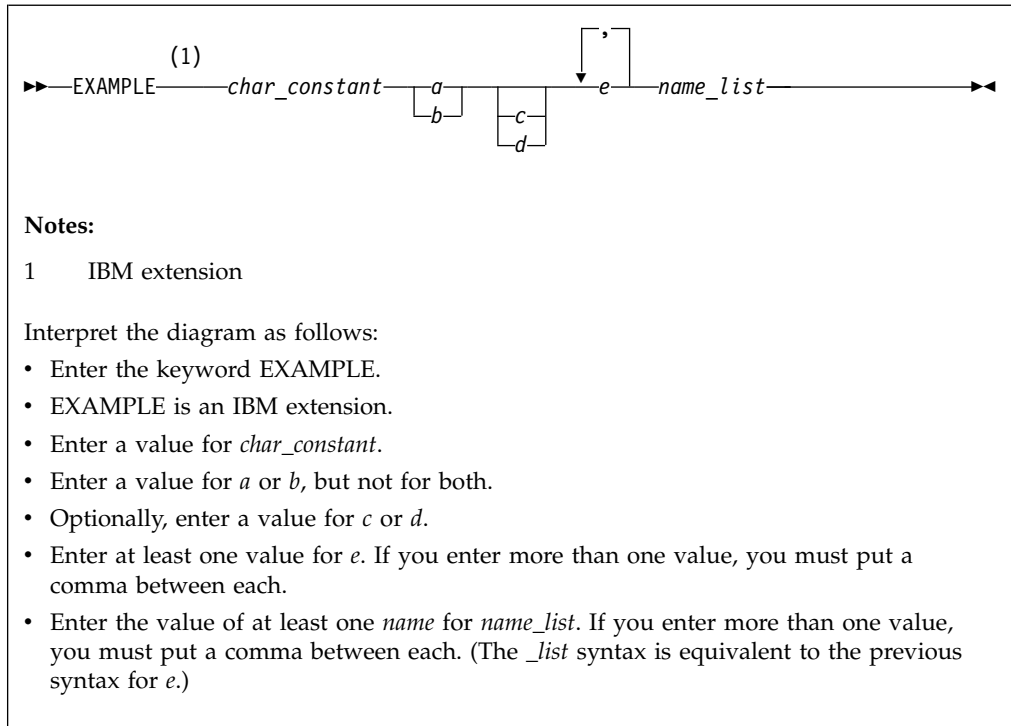

## How to read syntax statements

Syntax statements are read from left to right:

- Individual required arguments are shown with no special notation.
- When you must make a choice between a set of alternatives, they are enclosed by { and } symbols.
- Optional arguments are enclosed by [ and ] symbols.
- When you can select from a group of choices, they are separated by | characters.
- Arguments that you can repeat are followed by ellipses (...).

## Example of a syntax statement

`EXAMPLE char_constant {a|b}[c|d]e[,e]... name_list{name_list}...`

The following list explains the syntax statement:

- Enter the keyword `EXAMPLE`.
- Enter a value for `char_constant`.
- Enter a value for `a` or `b`, but not for both.
- Optionally, enter a value for `c` or `d`.
- Enter at least one value for `e`. If you enter more than one value, you must put a comma between each.
- Optionally, enter the value of at least one `name` for `name_list`. If you enter more than one value, you must put a comma between each `name`.

**Note:** The same example is used in both the syntax-statement and syntax-diagram representations.

## Examples in this information

The examples in this information, except where otherwise noted, are coded in a simple style that does not try to conserve storage, check for errors, achieve fast performance, or demonstrate all possible methods to achieve a specific result.

The examples for installation information are labelled as either *Example* or *Basic example*. *Basic examples* are intended to document a procedure as it would be performed during a basic, or default, installation; these need little or no modification.

## Notes on the terminology used

Some of the terminology in this information is shortened as follows:

- The term *free source form format* often appears as *free source form*.
- The term *fixed source form format* often appears as *fixed source form*.
- The term *XL Fortran* often appears as *XLF*.

---

## Related information

The following sections provide related information for XL Fortran:

### IBM XL Fortran information

XL Fortran provides product information in the following formats:

- Quick Start Guide

The Quick Start Guide (`quickstart.pdf`) is intended to get you started with IBM XL Fortran for AIX, V15.1.3. It is located by default in the XL Fortran directory and in the `\quickstart` directory of the installation DVD.

- README files

README files contain late-breaking information, including changes and corrections to the product information. README files are located by default in the XL Fortran directory and in the root directory of the installation DVD.

- Installable man pages

Man pages are provided for the compiler invocations and all command-line utilities provided with the product. Instructions for installing and accessing the man pages are provided in the *IBM XL Fortran for AIX, V15.1.3 Installation Guide*.

- Online product documentation

The fully searchable HTML-based documentation is viewable in IBM Knowledge Center at [http://www.ibm.com/support/knowledgecenter/SSGH4D\\_15.1.3/com.ibm.compilers.aix.doc/welcome.html](http://www.ibm.com/support/knowledgecenter/SSGH4D_15.1.3/com.ibm.compilers.aix.doc/welcome.html).

- PDF documents

PDF documents are available on the web at <http://www.ibm.com/support/docview.wss?uid=swg27036673>.

The following files comprise the full set of XL Fortran product information:

Table 3. XL Fortran PDF files

Document title	PDF file name	Description
<i>IBM XL Fortran for AIX, V15.1.3 Installation Guide, SC27-4243-02</i>	<code>install.pdf</code>	Contains information for installing XL Fortran and configuring your environment for basic compilation and program execution.

Table 3. XL Fortran PDF files (continued)

Document title	PDF file name	Description
<i>Getting Started with IBM XL Fortran for AIX, V15.1.3, SC27-4242-02</i>	getstart.pdf	Contains an introduction to the XL Fortran product, with information about setting up and configuring your environment, compiling and linking programs, and troubleshooting compilation errors.
<i>IBM XL Fortran for AIX, V15.1.3 Compiler Reference, SC27-4244-02</i>	compiler.pdf	Contains information about the various compiler options and environment variables.
<i>IBM XL Fortran for AIX, V15.1.3 Language Reference, SC27-4245-02</i>	langref.pdf	Contains information about the Fortran programming language as supported by IBM, including language extensions for portability and conformance to nonproprietary standards, compiler directives and intrinsic procedures.
<i>IBM XL Fortran for AIX, V15.1.3 Optimization and Programming Guide, SC27-4246-02</i>	proguide.pdf	Contains information on advanced programming topics, such as application porting, interlanguage calls, floating-point operations, input/output, application optimization and parallelization, and the XL Fortran high-performance libraries.

To read a PDF file, use Adobe Reader. If you do not have Adobe Reader, you can download it (subject to license terms) from the Adobe website at <http://www.adobe.com>.

More information related to XL Fortran, including IBM Redbooks® publications, white papers, and other articles, is available on the web at <http://www.ibm.com/support/docview.wss?uid=swg27036673>.

For more information about Fortran, see the Fortran café at <https://www.ibm.com/developerworks/mydeveloperworks/groups/service/html/communityview?communityUuid=b10932b4-0edd-4e61-89f2-6e478ccba9aa>.

## Standards and specifications

XL Fortran is designed to support the following standards and specifications. You can refer to these standards and specifications for precise definitions of some of the features found in this information.

- *American National Standard Programming Language FORTRAN, ANSI X3.9-1978.*
- *American National Standard Programming Language Fortran 90, ANSI X3.198-1992.*
- *ANSI/IEEE Standard for Binary Floating-Point Arithmetic, ANSI/IEEE Std 754-1985.*
- *Federal (USA) Information Processing Standards Publication Fortran, FIPS PUB 69-1.*
- *Information technology - Programming languages - Fortran, ISO/IEC 1539-1:1991. (This information uses its informal name, Fortran 90.)*
- *Information technology - Programming languages - Fortran - Part 1: Base language, ISO/IEC 1539-1:1997. (This information uses its informal name, Fortran 95.)*
- *Information technology - Programming languages - Fortran - Part 1: Base language, ISO/IEC 1539-1:2004. (This information uses its informal name, Fortran 2003.)*
- *Information technology - Programming languages - Fortran - Part 1: Base language, ISO/IEC 1539-1:2010. (This information uses its informal name, Fortran 2008. We currently provide partial support to this standard.)*

- *Information technology - Further interoperability of Fortran with C, ISO/IEC TS 29113:2012.* (This information uses its informal name, Technical specification 29113, referred to as TS 29113. We currently provide partial support to this specification.)
- *Military Standard Fortran DOD Supplement to ANSI X3.9-1978, MIL-STD-1753* (United States of America, Department of Defense standard). Note that XL Fortran supports only those extensions documented in this standard that have also been subsequently incorporated into the Fortran 90 standard.
- *OpenMP Application Program Interface Version 3.1* (full support), and *OpenMP Application Program Interface Version 4.0* (partial support), available at <http://www.openmp.org>

## Other IBM information

- *Parallel Environment for AIX: Operation and Use*
- The IBM Systems Information Center, at <http://publib.boulder.ibm.com/infocenter/systems/index.jsp?topic=/com.ibm.aix.doc/doc/base/aixparent.htm>, is a resource for AIX information.

You can find the following books for your specific AIX system:

- *AIX Commands Reference, Volumes 1 - 6*
- *Technical Reference: Base Operating System and Extensions, Volumes 1 & 2*
- *AIX National Language Support Guide and Reference*
- *AIX General Programming Concepts: Writing and Debugging Programs*
- *AIX Assembler Language Reference*

---

## Technical support

Additional technical support is available from the XL Fortran Support page at [http://www.ibm.com/support/entry/portal/product/rational/xl\\_fortran\\_for\\_aix](http://www.ibm.com/support/entry/portal/product/rational/xl_fortran_for_aix). This page provides a portal with search capabilities to a large selection of Technotes and other support information.

If you cannot find what you need, you can send an email to [compinfo@cn.ibm.com](mailto:compinfo@cn.ibm.com).

For the latest information about XL Fortran, visit the product information site at <http://www.ibm.com/software/products/en/xlfortran-aix>.

---

## How to send your comments

Your feedback is important in helping us to provide accurate and high-quality information. If you have any comments about this information or any other XL Fortran information, send your comments to [compinfo@cn.ibm.com](mailto:compinfo@cn.ibm.com).

Be sure to include the name of the manual, the part number of the manual, the version of XL Fortran, and, if applicable, the specific location of the text you are commenting on (for example, a page number or table number).



---

## Chapter 1. Optimizing your applications

The XL compilers enable development of high performance 32-bit and 64-bit applications by offering a comprehensive set of performance enhancing techniques that exploit the multilayered PowerPC® architecture. These performance advantages depend on good programming techniques, thorough testing and debugging, followed by optimization, and tuning.

---

### Distinguishing between optimization and tuning

You can use optimization and tuning separately or in combination to increase the performance of your application. Understanding the difference between them is the first step in understanding how the different levels, settings, and techniques can increase performance.

#### Optimization

Optimization is a compiler-driven process that searches for opportunities to restructure your source code and give your application better overall performance at run time, without significantly impacting development time. The XL compiler optimization suite, which you control using compiler options and directives, performs best on well-written source code that has already been through a thorough debugging and testing process. These optimization transformations can bring the following benefits:

- Reduce the number of instructions that your application executes to perform critical operations.
- Restructure your object code to make optimal use of the PowerPC architecture.
- Improve memory subsystem usage.
- Exploit the ability of the architecture to handle large amounts of shared memory parallelization.

Each basic optimization technique can result in a performance benefit, although not all optimizations can benefit all applications. Consult the “Steps in the optimization process” on page 2 for an overview of the common sequence of steps that you can use to increase the performance of your application.

#### Tuning

Tuning is a user-driven process where you experiment with changes, for example to source code or compiler options, to make the compiler better optimize your program. While optimization applies general transformations designed to improve the performance of any application in any supported environment, tuning offers you opportunities to adjust specific characteristics or target execution environments of your application to improve its performance. Even at low optimization levels, tuning for your application and target architecture can have a positive impact on performance. With proper tuning, the compiler can make the following improvements:

- Select more efficient machine instructions.
- Generate instruction sequences that are more relevant to your application.
- Select from more focussed optimizations to improve your code.

For instructions, see Tuning XL compiler applications.

---

## Steps in the optimization process

When you begin the optimization process, consider that not all optimization techniques suit all applications. Trade-offs sometimes occur between an increase in compile time, a reduction in debugging capability, and the improvements that optimization can provide.

Learning about and experimenting with different optimization techniques can help you strike the right balance for your XL compiler applications while achieving the best possible performance. Also, though it is unnecessary to hand-optimize your code, compiler-friendly programming can be extremely beneficial to the optimization process. Unusual constructs can obscure the characteristics of your application and make performance optimization difficult. Use the steps in this section as a guide for optimizing your application.

1. The Basic optimization step begins your optimization processes at levels 0 and 2.
2. The Advanced optimization step exposes your application to more intense optimizations at levels 3, 4, and 5.
3. The High-order transformation (HOT) step can help you reduce loop execution time.
4. The Interprocedural analysis (IPA) step can optimize your entire application at once.
5. The Profile-directed feedback (PDF) step focuses optimizations on specific characteristics of your application.
6. The Debugging optimized code step can help you identify issues and problems that can occur with optimized code.
7. The Getting more performance section offers other strategies and tuning alternatives to compiler-driven optimization.

The section Compiler-friendly programming techniques contains tips for writing more easily optimized source code.

---

## Basic optimization

The XL compiler supports several levels of optimization, with each option level building on the levels below through increasingly aggressive transformations and consequently using more machine resources.

Ensure that your application compiles and executes properly at low optimization levels before you try more aggressive optimizations. This topic discusses two optimizations levels, listed with complementary options in Table 4. The table also includes a column for compiler options that can have a performance benefit at that optimization level for some applications.

*Table 4. Basic optimizations*

Optimization level	Additional options implied by default	Complementary options	Other options with possible benefits
<b>-O0</b>	None	<b>-qarch</b>	None
<b>-O2</b>	<b>-qmaxmem=8192</b>	<b>-qarch</b> <b>-qtune</b>	<b>-qmaxmem=-1</b> <b>-qhot=level=0</b>

**Note:** Specifying `-O` without including a level implies `-O2`.

## Optimizing at level 0

### Benefits at level 0

- Provides minimal performance improvement with minimal impact on machine resources
- Exposes some source code problems that can be helpful in the debugging process

Begin your optimization process at `-O0`, which the compiler already specifies by default. This level performs basic analytical optimization by removing obviously redundant code, and it can result in better compile time. It also ensures your code is algorithmically correct so you can move forward to more complex optimizations. `-O0` also includes some redundant instruction elimination and constant folding. The `-qfloat=nofold` option can be used to suppress folding floating-point operations. Optimizing at this level accurately preserves all debugging information and can expose problems in existing code, such as uninitialized variables.

Additionally, specifying `-qarch` at this level targets your application for a particular machine and can significantly improve performance by ensuring that your application takes advantage of all applicable architectural benefits.

**Note:** For SMP programs, you need to add an additional option `-qsmp=noopt`.

For more information about tuning, consult *Tuning for Your Target Architecture*.

See `"-O"` in the *XL Fortran Compiler Reference* for information about the `-O` level syntax.

**Related information in the *XL Fortran Compiler Reference***

 `-qarch`

## Optimizing at level 2

### Benefits at level 2

- Eliminates redundant code
- Performs basic loop optimization
- Structures code to take advantage of `-qarch` and `-qtune` settings

After you successfully compile, execute, and debug your application using `-O0`, recompiling at `-O2` opens your application to a set of comprehensive low-level transformations that apply to subprogram or compilation unit scopes and can include some inlining. Optimizations at `-O2` attain a relative balance between increasing performance while limiting the impact on compilation time and system resources. You can increase the memory available to some of the optimizations in the `-O2` portfolio by providing a larger value for the `-qmaxmem` option. Specifying `-qmaxmem=-1` allows the optimizer to use memory as needed without checking for limits but does not change the transformations the optimizer applies to your application at `-O2`.

### Starting to tune at level 2

Choosing the right hardware architecture target or family of targets becomes even more important at `-O2` and higher. By targeting the proper hardware, the optimizer can make the best use of the available hardware facilities. If you choose a family of

hardware targets, the **-qtune** option can direct the compiler to emit code that is consistent with the architecture choice and that can execute optimally on the chosen tuning hardware target. With this option, you can compile for a general set of targets and have the code run best on a particular target.

For details on the **-qarch** and **-qtune** options, see Chapter 2, “Tuning XL compiler applications,” on page 39.

The **-O2** option can perform a number of additional optimizations as follows:

- Common subexpression elimination: Eliminates redundant instructions
- Constant propagation: Evaluates constant expressions at compile time
- Dead code elimination: Eliminates instructions that a particular control flow does not reach or that generate an unused result
- Dead store elimination: Eliminates unnecessary variable assignments
- Global register allocation: Globally assigns user variables to registers
- Value numbering: Simplifies algebraic expressions by eliminating redundant computations
- Instruction scheduling for the target machine
- Loop unrolling and software pipelining
- Moving loop-invariant code out of loops
- Simplifying control flow
- Strength reduction and effective use of addressing modes
- Widening: Merges adjacent load/stores and other operations
- Pointer aliasing improvements to enhance other optimizations

Even with **-O2** optimizations, some useful information about your source code is made available to the debugger if you specify **-g**. Using a higher **-g** level increases the information provided to the debugger but reduces the optimization that can be done. Conversely, higher optimization levels can transform code to an extent to which debugging information is no longer accurate.

The section on Chapter 5, “Debugging optimized code,” on page 59 discusses other debugging strategies in detail.

See “-O” in the *XL Fortran Compiler Reference* for information on the **-O** level syntax.

---

## Advanced optimization

Higher optimization levels can have a tremendous impact on performance, but some trade-offs can occur in terms of code size, compile time, resource requirements, and numeric or algorithmic precision.

After applying “Basic optimization” on page 2 and successfully compiling and executing your application, you can apply more powerful optimization tools. The XL compiler optimization portfolio includes many options for directing advanced optimization, and the transformations that your application undergoes are largely under your control. The discussion of each optimization level in Table 5 on page 5 includes information on the performance benefits and the possible trade-offs and information on how you can help guide the optimizer to find the best solutions for your application.

Table 5. Advanced optimizations

Optimization Level	Additional options implied	Complementary options	Options with possible benefits
-03	-qnostrict -qmaxmem=-1 -qhot=level=0	-qarch -qtune	-qpdf
-04	-qnostrict -qmaxmem=-1 -qhot -qipa -qarch=auto -qtune=auto -qcache=auto	-qarch -qtune -qcache	-qpdf -qsmp=auto
-05	All of -04 -qipa=level=2	-qarch -qtune -qcache	-qpdf -qsmp=auto

When you compile programs with any of the following sets of options:

- **-qhot -qnostrict**
- **-03 -qhot**
- **-04**
- **-05**

the compiler automatically attempts to vectorize calls to system math functions by calling the equivalent vector functions in the Mathematical Acceleration Subsystem libraries (MASS), with the exceptions of functions `vatan2`, `vsatan2`, `vdnint`, `vdint`, `vcosisin`, `vscosisin`, `vqdrct`, `vsqdrct`, `vrqdrct`, `vsrqdrct`, `vpopcnt4`, and `vpopcnt8`. If the compiler cannot vectorize, it automatically tries to call the equivalent MASS scalar functions. For automatic vectorization or scalarization, the compiler uses versions of the MASS functions contained in the system library `libxlopt.a`.

In addition to any of the preceding sets of options, when the **-qipa** option is in effect, if the compiler cannot vectorize, it tries to inline the MASS scalar functions before deciding to call them.

## Optimizing at level 3

### Benefits at level 3

- In-depth “Aliasing” on page 49 analysis
- Better loop scheduling
- High-order loop analysis and transformations (**-qhot=level=0**)
- Inlining of small procedures within a compilation unit by default
- Eliminating implicit compile-time memory usage limits

Specifying **-03** initiates more intense low-level transformations that remove many of the limitations present at **-02**. For instance, the optimizer no longer checks for memory limits, by setting the default to **-qmaxmem=-1**. Additionally, optimizations encompass larger program regions and attempt more in-depth analysis. Although not all applications contain opportunities for the optimizer to provide a measurable increase in performance, most applications can benefit from this type of analysis.

## Potential trade-offs at level 3

With the in-depth analysis of **-O3** comes a trade-off in terms of compilation time and memory resources. Also, because **-O3** implies **-qnostrict**, the optimizer can alter certain floating-point semantics in your application to gain execution speed. This typically involves precision trade-offs as follows:

- Reordering of floating-point computations
- Reordering or elimination of possible exceptions, such as division by zero or overflow
- Using alternative calculations that might give slightly less precise results or not handle infinities or NaNs in the same way

You can still gain most of the **-O3** benefits while preserving precise floating-point semantics by specifying **-qstrict**. Compiling with **-qstrict** is necessary if you require the same absolute precision in floating-point computational accuracy as you get with **-O0**, **-O2**, or **-qnoopt** results. The option **-qstrict=ieee** also ensures adherence to all IEEE semantics for floating-point operations. If your application is sensitive to floating-point exceptions or the order of evaluation for floating-point arithmetic, compiling with **-qstrict**, **-qstrict=exceptions**, or **-qstrict=order** helps to ensure accurate results. You should also consider the impact of the **-qstrict=precision** suboption group on floating-point computational accuracy. The precision suboption group includes the individual suboptions: **subnormals**, **operationprecision**, **association**, **reductionorder**, and **library** (described in the **-qstrict** option in the *XL Fortran Compiler Reference*).

Without **-qstrict**, the difference in computation for any one source-level operation is very small in comparison to “Basic optimization” on page 2. Although a small difference can be compounded if the operation is in a loop structure where the difference becomes additive, most applications are not sensitive to the changes that can occur in floating-point semantics.

For information about the **-O** level syntax, see “-O” in the *XL Fortran Compiler Reference*.

## An intermediate step: adding **-qhot** suboptions at level 3

At **-O3**, the optimization includes minimal **-qhot** loop transformations at **level=0** to increase performance. To further increase your performance benefit from **-qhot**, increase the optimization aggressiveness by increasing the optimization level of **-qhot**. Try specifying **-qhot** without any suboptions or **-qhot=level=1**.

The following **-qhot** suboptions can also provide additional performance benefits, depending on the characteristics of your application:

- **-qhot=vector** to enable long vectorization
- **-qhot=arraypad** to enable array padding
- **-qhot=fastmath** to enable the replacement of math routines with those from the XLOPT library

For more information about **-qhot**, see “High-order transformation (HOT)” on page 9.

Conversely, if the application does not use loops processing arrays, which **-qhot** improves, you can improve compile speed significantly, usually with minimal performance loss by using **-qnohot** after **-O3**.

## Optimizing at level 4

### Benefits at level 4

- Propagation of global and argument values between compilation units
- Inlining code from one compilation unit to another
- Reorganization or elimination of global data structures
- An increase in the precision of aliasing analysis

Optimizing at **-O4** builds on **-O3** by triggering **-qipa=level=1**, which performs interprocedural analysis (IPA), optimizing your entire application as a unit. This option is particularly pertinent to applications that contain a large number of frequently used routines.

To make full use of IPA optimizations, you must specify **-O4** on the compilation and link steps of your application build as interprocedural analysis occurs in stages at both compile time and link time.

Beyond **-qipa**, **-O4** enables other optimization options:

- **-qhot**

Enables more aggressive HOT transformations to optimize loop constructs and array language.

- **-qhot=vector**

Optimizes array data to run mathematical operations in parallel where applicable.

- **-qarch=auto** and **-qtune=auto**

Optimizes your application to execute on a hardware architecture identical to your build machine. If the architecture of your build machine is incompatible with the execution environment of your application, you must specify a different **-qarch** suboption after the **-O4** option. This overrides **-qtune=auto**.

- **-qcache=auto**

Optimizes your cache configuration for execution on specific hardware architecture. The **auto** suboption assumes that the cache configuration of your build machine is identical to the configuration of your execution architecture. Specifying a cache configuration can increase program performance, particularly loop operations by blocking them to process only the amount of data that can fit into the data cache at a time.

If you want to execute your application on a different machine, specify correct cache values.

### Potential trade-offs at level 4

In addition to the trade-offs already mentioned for **-O3**, specifying **-qipa** can significantly increase compilation time, especially at the link step.

See "-O" in the *XL Fortran Compiler Reference* for information about the **-O** level syntax.

### The IPA process

1. At compile time optimizations occur on a file-by-file basis, as well as preparation for the link stage. IPA writes analysis information directly into the object files the compiler produces.
2. At the link stage, IPA reads the information from the object files and analyzes the entire application.

3. This analysis guides the optimizer on how to rewrite and restructure your application and apply appropriate **-03** level optimizations.

The “Interprocedural analysis (IPA)” on page 11 section contains more information about IPA including details on IPA suboptions.

## Optimizing at level 5

### Benefits at level 5

- Makes most aggressive optimizations available
- Makes full use of loop optimizations and “Interprocedural analysis (IPA)” on page 11

As the highest optimization level, **-05** includes all **-04** optimizations and deepens whole program analysis by increasing the **-qipa** level to 2. Compiling with **-05** also increases how aggressively the optimizer pursues aliasing improvements. Additionally, if your application contains a mix of C/C++ and Fortran code that you compile using the XL compilers, you can increase performance by compiling and linking your code with the **-05** option.

### Potential trade-offs at level 5

Compiling at **-05** requires more compilation time and machine resources than any other optimization levels, particularly if you include **-05** on the IPA link step. Compile at **-05** as the final phase in your optimization process after successfully compiling and executing your application at **-04**.

See “-O” in the *XL Fortran Compiler Reference* for information on the **-0** level syntax.

---

## Specialized optimization techniques

While some optimization techniques are active at advanced optimization levels, certain types of applications can receive a performance benefit even when you apply only basic optimizations.

*Table 6. Specialized optimization techniques*

Technique	Benefit
<b>HOT</b>	Minimizes loop execution time which is beneficial to most applications that contain large loops, or many small loops. <b>HOT</b> also improves memory access patterns in your application.
<b>IPA</b>	Performs whole program analysis, providing the optimization suite with a complete view of your entire application. This applies performance enhancements with more focus and robustness.
<b>PDF</b>	Targets the code paths your application executes most frequently for optimization.



Table 6. Specialized optimization techniques (continued)

Technique	Benefit
Vector technology	Vector technology is a PowerPC technology for accelerating the performance-driven, high-bandwidth communications and computing applications. You can use the vector technology to get dramatic performance improvement for your applications.
Compiler reports	You can use the <code>-qlistfmt</code> option to generate a compiler report in XML 1.0 format that indicates some of the details of how your program was optimized. You can use this information to understand your application code and to tune your code for better performance.

## High-order transformation (HOT)

As part of the XL compiler optimization suite, the HOT transformations focus specifically on loops which typically account for the majority of the execution time for most applications. HOT transformations perform in-depth loop analysis to minimize their execution time.

Loop optimization analysis includes:

- Interchange
- Fusion
- Unrolling loop nests
- Reducing the use of temporary arrays

The goals of these optimizations include:

- Reducing memory access costs through effective cache use and translation look-aside buffers (TLBs). Increasing memory locality reduces cache and TLB misses.
- Overlapping computation and memory access through effective utilization of the hardware data prefetching capabilities.
- Improving processor resource utilization by reordering and balancing the use of instructions with complementary resource requirements. Loop computation balance typically involves creating an equitable relationship between load/store operations and floating-point computations.

Compiling with `-O3` and higher triggers HOT transformations by default. You can also see performance benefits by specifying `-qhot` with `-O2`, or adding more `-qhot` optimizations than the default `level=0` at `-O3`.

You can see particular `-qhot` benefits if your application contains Fortran 90-style array language constructs, as HOT transformations include elimination of intermediate temporary variables and statement fusion.

You can also use directives to assist in loop analysis. Assertive directives such as `INDEPENDENT` or `CNCALL` allow you to describe important loop characteristics or behaviors that HOT transformations can exploit. Prescriptive directives such as `UNROLL` or `PREFETCH` allow you to direct the HOT transformations on a loop-by-loop basis. You can also specify the `-qreport` compiler option to generate

information about loop transformations. The report can assist you in deciding where best to include directives to improve the performance of your application. For example, you can use this section of the listing to identify non-stride-one references that may prevent loop vectorization.

You can use the **-qreport** option in conjunction with **-qhot** or any optimization option that implies **-qhot** to produce a pseudo-Fortran report showing how the loops were transformed. The LOOP TRANSFORMATION SECTION of the listing file also contains information about data prefetch insertion locations.

When used with **-qsmp**, **-qhot=level=2** instructs the compiler to perform the transformations of **-qhot=level=1** plus some additional transformation on nested loops. The resulting loop analysis and transformations can lead to more cache reuse and loop parallelization. If you use **-qhot=level=2** and **-qsmp** together with **-qreport** or **-qlistfmt**, you can see this information on aggressive loop analysis performed on loop nests in the LOOP TRANSFORMATION SECTION of the listing file or compiler report.

When you use **-qprefetch=assistthread** to generate prefetching assist threads, a message Assist thread for data prefetching was generated also appears in the LOOP TRANSFORMATION SECTION of the listing file. For details, see **-qprefetch** in the *XL Fortran Compiler Reference*.

With the **-qassert=refalign** suboption, the compiler might generate more efficient code. This assertion is particularly useful when you target a Single Instruction Multiple Data (SIMD) architecture with **-qhot=level=0** or **-qhot=level=1** with the **-qsimd=auto** option.

In addition to general loop transformation, **-qhot** supports suboptions that you can specify to enable additional transformations detailed in this section.

### **HOT short vectorization**

When you are targeting a PowerPC processor that supports Vector Multimedia Extension (VMX) or Vector Scalar Extension (VSX), you can specify **-qsimd=auto** to enable the compiler to transform code into VMX or VSX instructions. These machine instructions can execute up to sixteen operations in parallel. This transformation mostly applies to the loops that iterate over contiguous array data and perform calculations on each element. You can use the **NOSIMD** directive to prevent the transformation of a particular loop.

### **HOT long vectorization**

When you specify any of the following:

- **-04** and higher
- **-qhot** with **-qnostrict**

you enable **-qhot=vector** by default. Specifying **-qnostrict** with optimizations other than **-04** and **-05** ensures that the compiler looks for long vectorization opportunities. This can optimize loops in source code for operations on array data by ensuring that operations run in parallel where applicable. The compiler uses standard machine registers for these transformations and does not restrict vector data size; supporting both single- and double-precision floating-point vectorization. Often, HOT vectorization involves transformations of loop calculations into calls to specialized mathematical routines supplied with the compiler such as the Mathematical Acceleration Subsystem (MASS) libraries. These mathematical routines use algorithms that calculate results more efficiently than executing the original loop code.

For more information about optimization levels like **-O4** and the other compiler options they imply, see “Advanced optimization” on page 4.

### **HOT array size adjustment**

An array dimension that is a power of two can lead to a decrease in cache utilization. The **-qhot=arraypad** suboption allows the compiler to increase the dimensions of arrays where doing so could improve the efficiency of array-processing loops. Using this suboption can reduce cache misses and page faults that slow your array processing programs. The HOT transformations will not necessarily pad all arrays, and can pad different arrays by different amounts in order to gain performance. You can specify a padding factor to apply to all arrays. This value is typically a multiple of the largest array element size.

Use **-qhot=arraypad** with discretion as array padding uses more memory and the performance trade-off does not benefit all applications. Also, these HOT transformations do not include checks for array data overlay, as with Fortran **EQUIVALENCE**, or array shaping operations.

### **HOT fast scalar math routines**

The XLOPT library contains faster versions of certain math functions that are normally provided by the operating system or in the default run time. With **-qhot=fastmath**, the compiler replaces calls to the math functions with their faster counterparts in XLOPT library. This option requires **-qstrict=nolibrary** in effect.

## **Interprocedural analysis (IPA)**

Interprocedural Analysis (IPA) can analyze and optimize your application as a whole, rather than on a file-by-file basis.

Run during the link step of an application build, the entire application, including linked libraries, is available for interprocedural analysis. This whole program analysis opens your application to a powerful set of transformations available only when more than one file or compilation unit is accessible. IPA optimizations are also effective on mixed language applications.

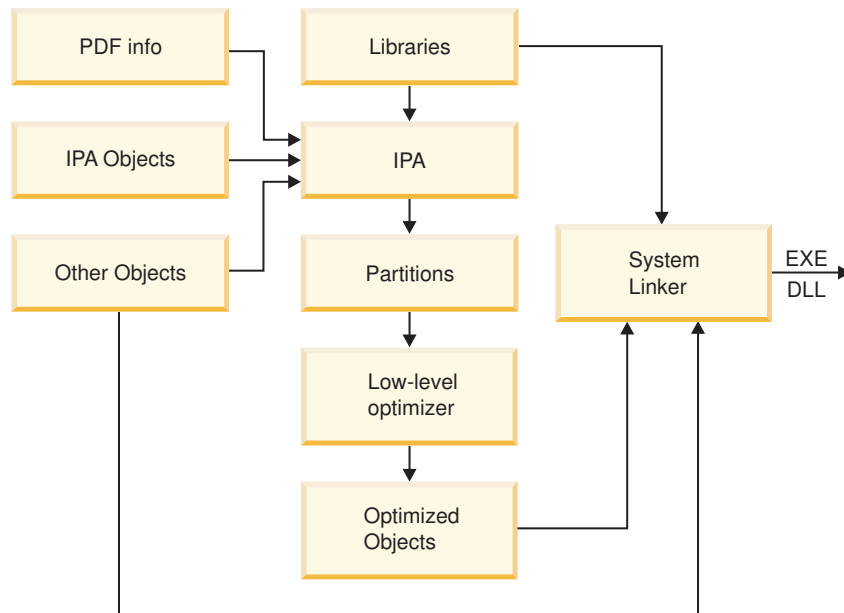

Figure 1. IPA at the link step

The following are some of the link-time transformations that IPA can use to restructure and optimize your application:

- Inlining between compilation units.
- Complex data flow analyses across subprogram calls to eliminate parameters or propagate constants directly into called subprograms.
- Improving parameter usage analysis, or replacing external subprogram calls to system libraries with more efficient inline code.
- Restructuring data structures to maximize access locality.
- Cloning subprograms where calls pass constant parameters to allow optimizing expressions using those parameters.

In order to maximize IPA link-time optimization, you must use IPA at both the compile and link step. Objects you do not compile with IPA can only provide minimal information to the optimizer, and receive minimal benefit. However when IPA is active on the compile step, the resulting object file contains program information that IPA can read during the link step. The program information is invisible to the system linker, and you can still use the object file and link without invoking IPA. The IPA optimizations use hidden information to reconstruct the original compilation and can completely analyze the subprograms the object contains in the context of their actual usage in your application.

During the link step, IPA restructures your application, partitioning it into distinct logical code units. After IPA optimizations are complete, IPA applies the same low-level compilation-unit transformations as the **-O2** and **-O3** base optimizations levels. Following those transformations, the compiler creates one or more object files and linking occurs with the necessary libraries through the system linker.

It is important that you specify a set of compilation options as consistent as possible when compiling and linking your application. This includes all compiler options, not just **-qipa** suboptions. When possible, specify identical options on all compilations and repeat the same options on the IPA link step. Incompatible or

conflicting options that you specify to create object files, or link-time options in conflict with compile-time options can reduce the effectiveness of IPA optimizations.

**Notes:**

- XL C/C++ and XL Fortran provide backwards compatibility with IPA objects that are created by earlier compiler versions. If IPA object files that are compiled with newer versions of compilers are linked by an earlier version, errors occur during the link step. For example, if IPA object file `a.o` is compiled by XL C/C++, V13.1.3 and is to be linked with IPA object file `b.o` that is compiled by XL Fortran, V15.1.0, then you must use a compiler whose version is XL C/C++, V13.1.3 or later.
- XL C/C++ and XL Fortran versions released at the same time produce matching IPA level information and can be linked together. For example, the IPA for XL C/C++, V13.1.3 matches with the IPA for XL Fortran, V15.1.3, because these compilers are released at the same time. For example, the IPA level for XL C/C++, V13.1.3 matches with the IPA for XL Fortran, V15.1.3. The following table lists some matching XL C/C++ and XL Fortran releases:

*Table 7. Compiler versions and release date*

Compiler version	General availability (Release date)
XL C for AIX, V13.1.3	11-Dec-2015
XL C/C++ for AIX, V13.1.3	
XL Fortran for AIX, V15.1.3	
XL C for AIX, V13.1.0	06-Jun-2014
XL C/C++ for AIX, V13.1.0	
XL Fortran for AIX, V15.1.0	
XL C for AIX, V12.1.0	18-May-2012
XL C/C++ for AIX, V12.1.0	
XL Fortran for AIX, V14.1.0	

For more information about the release dates of compiler products, see [http://www.ibm.com/software/support/lifecycle/index\\_x.html](http://www.ibm.com/software/support/lifecycle/index_x.html)

If your compiler version has two release dates on the Support Lifecycle web site, determine the date based on your product ID.

**Using IPA on the compile step only**

IPA can still perform transformations if you do not specify IPA on the link step. Using IPA on the compile step initiates optimizations that can improve performance for an individual object file even if you do not link the object file using IPA. The primary focus of IPA is link-step optimization, but using IPA only on the compile-step can still be beneficial to your application without incurring the costs of link-time IPA.

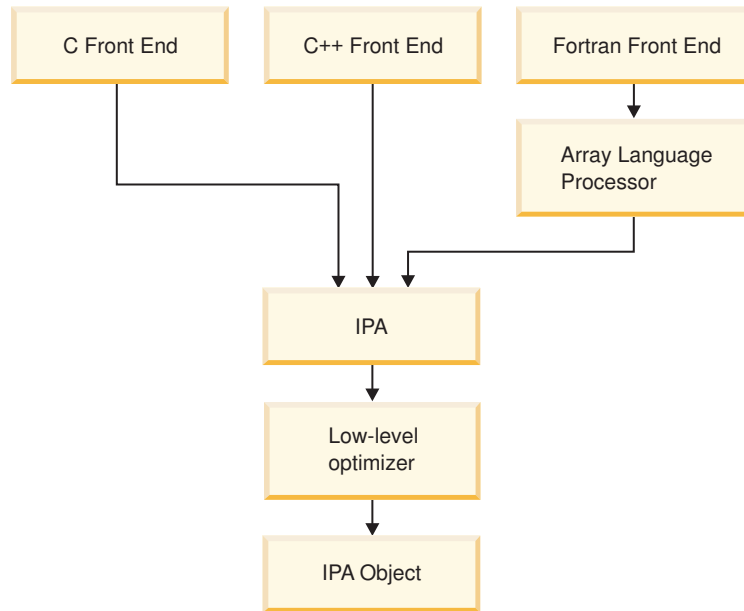

Figure 2. IPA at the compile step

### IPA Levels and other IPA suboptions

You can control many IPA optimization functions using the **-qipa** option and suboptions. The most important part of the IPA optimization process is the level at which IPA optimization occurs. Default compilation does not invoke IPA. If you specify **-qipa** without a level, or specify **-04**, IPA optimizations are at level one. If you specify **-05**, IPA optimizations are at level two.

Table 8. The levels of IPA

IPA Level	Behaviors
<b>qipa=level=0</b>	<ul style="list-style-type: none"> <li>Automatically recognizes standard library functions</li> <li>Localizes statically bound variables and procedures</li> <li>Organizes and partitions your code according to call affinity, expanding the scope of the <b>-02</b> and <b>-03</b> low-level compilation unit optimizer</li> <li>Lowers compilation time in comparison to higher levels, though limits analysis</li> </ul>
<b>qipa=level=1</b>	<ul style="list-style-type: none"> <li>Level 0 optimizations</li> <li>Performs procedure inlining across compilation units</li> <li>Organizes and partitions static data according to reference affinity</li> </ul>

Table 8. The levels of IPA (continued)

IPA Level	Behaviors
<code>qipa=level=2</code>	<ul style="list-style-type: none"> <li>• Level 0 and level 1 optimizations</li> <li>• Performs whole program alias analysis which removes ambiguity between pointer references and calls, while refining call side effect information</li> <li>• Propagates interprocedural constants</li> <li>• Eliminates dead code</li> <li>• Performs pointer analysis</li> <li>• Performs procedure cloning</li> <li>• Optimizes intraprocedural operations, using specifically:               <ul style="list-style-type: none"> <li>– Value numbering</li> <li>– Code propagation and simplification</li> <li>– Code motion, into conditions and out of loops</li> <li>– Redundancy elimination techniques</li> </ul> </li> <li>• Performs data reorganization</li> </ul>

IPA includes many suboptions that can help you guide IPA to perform optimizations important to the particular characteristics of your application. Among the most relevant to providing information on your application are:

- **lowfreq**, with which you can specify a list of procedures that are likely to be called infrequently during the course of a typical program run. Performance can increase because optimization transformations will not focus on these procedures.
- **partition**, with which you can specify the size of the regions within the program to analyze. Larger partitions contain more procedures, which result in better interprocedural analysis but require more storage to optimize.
- **threads**, with which you can specify the number of parallel threads available to IPA optimizations. This can provide an increase in compilation-time performance on multi-processor systems.

## Using IPA across the XL compiler family

The XL compiler family shares optimization technology. Object files you create using IPA on the compile step with the XL C, C++, and Fortran compilers can undergo IPA analysis during the link step. Where program analysis shows that objects were built with compatible options, such as **-qnostrict**, IPA can perform transformations such as inlining C functions into Fortran code, or propagating C++ constant data into C function calls.

## Profile-directed feedback

You can use profile-directed feedback (PDF) to tune the performance of your application for a typical usage scenario. The compiler optimizes the application based on an analysis of how often branches are taken and blocks of code are run.

Use the PDF process as one of the last steps of optimization before putting the application into production. Optimization at all levels from **-O2** up can benefit from PDF. Other optimizations such as the **-qipa** option and optimization levels **-O4** and **-O5** can also benefit from PDF process.

The following diagram illustrates the PDF process.

Figure 3. Profile-directed feedback

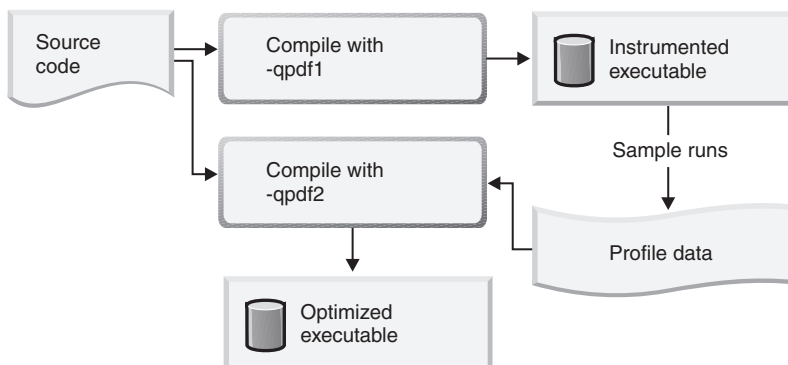

To use the PDF process to optimize your application, follow these steps:

1. Compile some or all of the source files in a program with the **-qpdf1** option. You must specify at least the **-O2** optimization level.

**Notes:**

- A PDF map file is generated at this step. It is used for the **showpdf** utility to display part of the profiling information in text or XML format. For details, see “Viewing profiling information with showpdf” on page 19. If you do not need to view the profiling information, specify the **-qnoshowpdf** option at this step so that the PDF map file is not generated. For details of **-qnoshowpdf**, see **-qshowpdf** in the *XL Fortran Compiler Reference*.
- Although you can specify PDF optimization (-qpdf) as early in the optimization level as **-O2**, PDF optimization is recommended at **-O4** and higher.
- You do not have to compile all of the files of the programs with the **-qpdf1** option. In a large application, you can concentrate on those areas of the code that can benefit most from the optimization.
- When option **-O4**, **-O5**, or any level of option **-qipa** is in effect, and you specify the **-qpdf1** option at the link step but not at the compile step, the compiler issues a warning message. The message indicates that you must recompile your program to get all the profiling information.

**Restriction:** When you run an application that is compiled with **-qpdf1**, you must end the application using normal methods, including reaching the end of the execution for the main function. System calls `exit()`, `_Exit()`, and `abort()` are considered abnormal termination methods and are not supported. Using abnormal program termination might result in incomplete instrumentation data generated by using the PDF file or PDF data not being generated at all.

2. Run the resulting application with a typical data set. When the application exits, profile information is written to one or more PDF files. You can train the resulting application multiple times with different data sets. The profiling information is accumulated to provide a count of how often branches are taken and blocks of code are run, based on the input data used. This step is called the PDF training step. By default, the PDF file is named `._pdf`, and it is placed in the current working directory or the directory specified by the PDFDIR environment variable. If the PDFDIR environment variable is set but the



specified directory does not exist, the compiler issues a warning message. To override the defaults, use the **-qpdf1=pdfname** or **-qpdf1=exename** option.

If you recompile your program with the **-qpdf1** option, the compiler removes the existing PDF file or files whose names and locations are the same as the file or files that will be created in the training step before generating a new application.

**Notes:**

- When you compile your program with the **-qpdf1** or **-qpdf2** option, by default, the **-qipa** option is also invoked with **level=0**.
  - To avoid wasting compile and run time, make sure that the PDFDIR environment variable is set to an absolute path. Otherwise, you might run the application from a wrong directory, and the compiler cannot locate the profiling information files. When it happens, the program might not be optimized correctly or might be stopped by a segmentation fault. A segmentation fault might also happen if you change the value of the PDFDIR environment variable and run the application before the PDF process finishes.
  - Avoid using atypical data. Otherwise, it might distort the analysis of infrequently executed code paths.
3. If you have several PDF files, use the **mergepdf** utility to combine these PDF files into one PDF file. For example, if you produce three PDF files that represent usage patterns that occur 53%, 32%, and 15% of the time respectively, you can use this command:

```
mergepdf -r 53 file_path1 -r 32 file_path2 -r 15 file_path3 -o file_path4
```

where *file\_path1*, *file\_path2*, and *file\_path3* specify the directories and names of the PDF files that are to be merged, and *file\_path4* specifies the directory and name of the output PDF file.

**Notes:**

- Avoid mixing the PDF files created by different versions or PTF levels of the XL Fortran compiler.
  - You cannot edit PDF files that are generated by the resulting application. Otherwise, the performance or function of the generated executable application might be affected.
4. Recompile your program using the same compiler options as before, but change **-qpdf1** to **-qpdf2**. In this second compilation, the accumulated profiling information is used to fine-tune the optimizations. The resulting program contains no profiling overhead and runs at full speed.

It is recommended that you use the **-qpdf2** option to link the object files that are created during the **-qpdf1** phase without recompiling your program. Using this approach, you can save considerable compilation time and achieve the same optimization result as if you had recompiled your program during the **-qpdf2** phase.

**Notes:**

- If the compiler cannot read any PDF files in this step, the compiler issues error message 1586-401 but continues the compilation. If you want the compiler to stop the compilation, specify **-qhaltonmsg=1586-401**.
- You are highly recommended to use the same optimization level at all compilation steps for a particular program. Otherwise, the PDF process

cannot optimize your program correctly and might even slow it down. All compiler settings that affect optimization must be the same, including any supplied by configuration files.

- You can modify your source code and use the **-qpdf1** and **-qpdf2** options to compile your program. Old profiling information can still be preserved and used during the second stage of the PDF process. The compiler issues a list of warnings but the compilation does not stop. An information message is also issued with a number in the range of 0 - 100 to indicate how outdated the old profiling information is.
- When option **-O4**, **-O5**, or any level of option **-qipa** is in effect, and you specify the **-qpdf2** option at the link step but not at the compile step, the compiler issues a warning message. The message indicates that you must recompile your program to get all the profiling information.
- When using the **-qreport** option with the **-qpdf2** option, you can get additional information in your listing file to help you tune your program. This information is written to the PDF Report section.

5. If you want to erase the PDF information, use the **cleanpdf** utility.

## Examples

The following example demonstrates that you can concentrate on compiling with **-qpdf1** only the code that can benefit most from the optimization, instead of compiling all the code with the **-qpdf1** option:

```
#Set the PDFDIR variable
export PDFDIR=$HOME/project_dir

#Compile most of the files with -qpdf1
xlf -qpdf1 -O3 -c file1.f file2.f file3.f

#This file does not need optimization
xlf -c file4.f

#Non-PDF object files such as file4.o can be linked
xlf -qpdf1 -O3 file1.o file2.o file3.o file4.o

#Run several times with different input data
./a.out < polar_orbit.data
./a.out < elliptical_orbit.data
./a.out < geosynchronous_orbit.data

#Link all the object files into the final application
xlf -qpdf2 -O3 file1.o file2.o file3.o file4.o
```

The following example bypasses recompiling the source with the **-qpdf2** option:

```
#Compile source with -qpdf1
xlf -c -qpdf1 -O3 file1.f file2.f

#Link object files
xlf -qpdf1 -O3 file1.o file2.o

#Run with one set of input data
./a.out < sample.data

#Link object files
xlf -qpdf2 -O3 file1.o file2.o
```

**Related information in the *XL Fortran Compiler Reference***

 **-qpdf1, -qpdf2**

 -O, -qoptimize

 PDF environment variables

## Viewing profiling information with showpdf

With the **showpdf** utility, you can view the following types of profiling information that is gathered from your application:

- Block-counter profiling
- Call-counter profiling
- Value profiling
- Cache-miss profiling, if you specified the **-qpdf1=level=2** option during the **-qpdf1** phase.

You can view the first two types of profiling information in either text or XML format. However, you can view value profiling and cache-miss profiling information only in XML format.

## Syntax

```
→ showpdf [pdfdir] [-f pdfname] [-m pdfmapdir] [-xml]
```

## Parameters

### pdfdir

Is the directory that contains the profile-directed feedback (PDF) file. If the PDFDIR environment variable is not changed after the **-qpdf1** phase, the PDF map file is also contained in this directory. If this parameter is not specified, the compiler uses the value of the PDFDIR environment variable as the name of the directory.

### pdfname

Is the name of the PDF file. If this parameter is not specified, the compiler uses `._pdf` as the name of the PDF file.

### pdfmapdir

Is the directory that contains the PDF map file. If this parameter is not specified, the compiler uses the value of the PDFDIR environment variable as the name of the directory.

### -xml

Determines the display format of the PDF information. If this parameter is specified, the PDF information is displayed in XML format; otherwise, it is displayed in text format. Because value profiling and cache-miss profiling information can be displayed only in XML format, the PDF report in XML format contains more information than the report in text format.

## Usage

A PDF map file that contains static information is generated during the **-qpdf1** phase, and a PDF file is generated during the execution of the resulting application. The **showpdf** utility needs both the PDF and PDF map files to display PDF information in either text or XML format.

By default, the PDF file is named `._pdf`, and the PDF map file is named `._pdf_map`. If the PDFDIR environment variable is set, the compiler places the PDF and PDF

map files in the directory specified by PDFDIR. Otherwise, the compiler places these files in the current working directory. If the PDFDIR environment variable is set but the specified directory does not exist, the compiler issues a warning message. To override the defaults, use the **-qpdf1=pdfname** option to specify the paths and names for the PDF and PDF map files. For example, if you specify the **-qpdf1=pdfname=/home/joe/func** option, the resulting PDF file is named func, and the PDF map file is named func\_map. Both of the files are placed in the /home/joe directory.

If the PDFDIR environment variable is changed between the **-qpdf1** phase and the execution of the resulting application, the PDF and PDF map files are generated in separate directories. In this case, you must specify the directories for both of these files to the **showpdf** utility.

**Notes:**

- PDF and PDF map files must be generated from the same compilation instance. Otherwise, the compiler issues an error.
- PDF and PDF map files must be generated during the same profiling process. This means that you cannot mix and match PDF and PDF map files that are generated from different profiling processes.
- You must use the same version and PTF level of the compiler to generate the PDF file and the PDF map file.
- The **showpdf** utility accepts only PDF files that are in binary format.
- You can use the PDF\_WL\_ID environment variable to distinguish the multiple sets of PDF counters that are generated by multiple training runs of the user program.

The following example shows how to use the **showpdf** utility to view the profiling information for a Hello World application:

The source for the program file `hello.f` is as follows:

```
PROGRAM P
  CALL HelloWorld()

CONTAINS

  SUBROUTINE HelloWorld()
    PRINT *, "Hello World"
  END SUBROUTINE HelloWorld

END PROGRAM P
END
```

1. Compile the source file.
 

```
xlf2008 -qpdf1 -0 hello.f
```
2. Run the resulting executable program using a typical data set or several typical data sets.
3. If you want to view the profiling information for the executable file in text format, run the **showpdf** utility without any parameters.

```
showpdf
```

The result is as follows:

```
...
-----
p(63): 1 (hello.f)

Call Counters:
2 | 1 @2@helloworld(64)
```

```
2 | 1 _xlfExit(65)
Call coverage = 100% ( 2/2 )
```

Block Counters:

```
1-10 | 1
10 |
```

Block coverage = 100% ( 1/1 )

```
-----
@2@helloworld(64): 1 (hello.f)
```

Call Counters:

```
7 | 1 _xlfBeginIO(66)
7 | 1 _xlfWriteLDChar(67)
7 | 1 _xlfEndIO(68)
```

Call coverage = 100% ( 3/3 )

Block Counters:

```
6-7 | 1
8 |
8 | 1
```

Block coverage = 100% ( 2/2 )

```
-----
_xlfExit(65): 1 undefined node
```

```
-----
_xlfBeginIO(66): 1 undefined node
```

```
-----
_xlfWriteLDChar(67): 1 undefined node
```

```
-----
_xlfEndIO(68): 1 undefined node
```

Total Call coverage = 100% ( 5/5 )

Total Block coverage = 100% ( 3/3 )

If you want to view the profiling information in XML format, run the **showpdf** utility with the **-xml** parameter.

```
showpdf -xml
```

The result is as follows:

```
<?xml version="1.0" encoding="UTF-8" ?>
- <XLTransformationReport xmlns="http://www.ibm.com/2010/04/CompilerTransformation" version="1.0">
  - <CompilationStep name="showpdf">
    <StepDetails>
      ...
      <Detail>
        <FieldTitle>Total Call coverage</FieldTitle>
        <FieldValue>100% ( 5/5 )</FieldValue>
      </Detail>
      <Detail>
        <FieldTitle>Total Block coverage</FieldTitle>
        <FieldValue>100% ( 3/3 )</FieldValue>
      </Detail>
    </StepDetails>
  <ProgramHierarchy>
    <FileList>
      <File id="1" name="hello.f">
        <RegionList>
          <Region id="63" name="p" startLineNumber="1"/>
        </RegionList>
      </File>
    </FileList>
  </ProgramHierarchy>
</XLTransformationReport>
```

```

    <Region id="64" name="@2@helloworld" startLineNumber="6"/>
  </RegionList>
</File>
</FileList>
</ProgramHierarchy>
<TransformationHierarchy/>
<ProfilingReports>
  <BlockCounterList>
    <BlockCounter regionId="63" execCount="1" coveredBlock="1" totalBlock="1">
      <BlockList>
        <Block index="3" execCount="1" startLineNumber="1" endLineNumber="10"/>
      </BlockList>
    </BlockCounter>
    <BlockCounter regionId="64" execCount="1" coveredBlock="2" totalBlock="2">
      <BlockList>
        <Block index="3" execCount="1" startLineNumber="6" endLineNumber="7"/>
        <Block index="4" execCount="1" startLineNumber="8" endLineNumber="8"/>
      </BlockList>
    </BlockCounter>
  </BlockCounterList>
  <CallCounterList>
    <CallCounter regionId="63" execCount="1" coveredCall="2" totalCall="2">
      <CallList>
        <Call name="@2@helloworld" execCount="1" lineNumber="2"/>
        <Call name="_xlfExit" execCount="1" lineNumber="2"/>
      </CallList>
    </CallCounter>
    <CallCounter regionId="64" execCount="1" coveredCall="3" totalCall="3">
      <CallList>
        <Call name="_xlfBeginIO" execCount="1" lineNumber="7"/>
        <Call name="_xlfWriteLDChar" execCount="1" lineNumber="7"/>
        <Call name="_xlfEndIO" execCount="1" lineNumber="7"/>
      </CallList>
    </CallCounter>
  </CallCounterList>
</ProfilingReports>
</CompilationStep>
</XLTransformationReport>

```

### Related information in the *XL Fortran Compiler Reference*



`-qpdf1, -qpdf2`



`-qshowpdf`

## Object level profile-directed feedback

### About this task

In addition to optimizing entire executables, profile-directed feedback (PDF) can also be applied to specific object files. This can be an advantage in applications where patches or updates are distributed as object files or libraries rather than as executables. Also, specific areas of functionality in your application can be optimized without the process of relinking the entire application. In large applications, you can save the time and trouble that otherwise need to be spent relinking the application.

The process for using object level PDF is essentially the same as the standard PDF process but with a small change to the **-qpdf2** step. For object level PDF, compile your program using the **-qpdf1** option, execute the resulting application with representative data, compile the program again with the **-qpdf2** option, but now also use the **-qnoipa** option so that the linking step is skipped.

The steps below outline this process:

1. Compile your program using the **-qpdf1** option. For example:

```
xlf -c -O3 -qpdf1 file1.f file2.f file3.f
```

In this example, we are using the optimization level **-O3** to indicate that we want a moderate level of optimization.

2. Link the object files to get an instrumented executable:

```
xlf -O3 -qpdf1 file1.o file2.o file3.o
```

3. Run the instrumented executable with sample data that is representative of the data you want to optimize for.

```
a.out < sample_data
```

4. Compile the program again using the **-qpdf2** option. Specify the **-qnoipa** option so that the linking step is skipped and PDF optimization is applied to the object files rather than to the entire executable.

```
xlf -c -O3 -qpdf2 -qnoipa file1.f file2.f file3.f
```

The resulting output of this step are object files optimized for the sample data processed by the original instrumented executable. In this example, the optimized object files would be file1.o, file2.o, and file3.o. These can be linked by using the system loader **ld** or by omitting the **-c** option in the **-qpdf2** step.

#### Notes:

- You must use the same optimization level in all the steps. In this example, the optimization level is **-O3**.
- If you want to specify a file name for the profile that is created, use the **pdfname** suboption in both the **-qpdf1** and **-qpdf2** steps. For example:

```
xlf -O3 -qpdf1=pdfname=myprofile file1.f file2.f file3.f
```

Without the **pdfname** suboption, by default the file name is `._pdf`; the location of the file is the current working directory or whatever directory you have set using the `PDFDIR` environment variable. If the `PDFDIR` environment variable is set but the specified directory does not exist, the compiler issues a warning message.

- Because the **-qnoipa** option needs to be specified in the **-qpdf2** step so that linking of your object files is skipped, you cannot use interprocedural analysis (IPA) optimizations and object level PDF at the same time.

For details, see `-qpdf1`, `-qpdf2` in the XL Fortran Compiler Reference.

## Handling table of contents (TOC) overflow

To handle table of contents (TOC) overflow, you can reduce the number of global symbols, enlarge the TOC access range, or apply interprocedural analysis.

The addresses of global symbols in programs are stored in a data structure called TOC. To access a global symbol, the address of the global symbol must be retrieved from the TOC. The default TOC data structure has a fixed size that can store a fixed number of global symbols. For example, the IBM PowerPC architecture uses an instruction with a signed 16-bit offset for indirect address calculations and limits the size of the TOC to 64 KB. A maximum of 16 K entries can be stored in the TOC in 32-bit mode and 8 K entries in 64-bit mode.

For large applications, it is common to have more global symbols than can be stored in the default TOC. If an application contains more TOC entries than the TOC can hold, the linker reports TOC overflow, indicating that an alternative mechanism must be used. Use the following approaches to handle TOC overflow:

- Reduce the number of global symbols in programs in the following ways:
  - Change the source code. It is the best approach to reduce the number of global symbols.
  - Specify the **-qminimaltoc** option.

- Apply interprocedural analysis by specifying the **-qipa** option. For more information about the option, see “Interprocedural analysis (IPA)” on page 11 and “IPA Levels and other IPA suboptions” on page 14.
- Enlarge the TOC access range by specifying the following options:
  - **-bbigtoc** (a linker option)
  - **-qplic=large**

### Options for reducing the number of global symbols

The best approach to handle table of contents (TOC) overflow is to reduce the number of global symbols so that the required number of TOC entries is also reduced.

You can reduce the number of global symbols by refining the source code. If possible, change the source code to remove unnecessary global variables and functions, mark them as static, or group global variables in structures. However, changing the source code can be time consuming and error prone. In fact, the compiler can finish these tasks automatically when link-time optimization is used at high optimization levels (**-O4** and **-O5**) or the optimization is applied explicitly with **-qipa** at both compile and link time. The optimization result is similar to what can be achieved through source changes but without widespread manual source changes.

To reduce the number of global symbols, you can also specify the **-qminimaltoc** option. When you specify this option, the compiler creates a separate table for each source file. The table contains the address of each global symbol that is used in the source file. Specifying the option ensures that the compiler creates only one TOC entry for each compilation unit. This option is effective only if the TOC entries are spread across multiple source files. If a single source file contains enough global symbols to cause TOC overflow, the option has no effect to help with TOC overflow.

#### Notes:

- It is unnecessary to specify **-qminimaltoc** for each compilation unit.
- Use **-qminimaltoc** with discretion because it might lead to low performance. The use of **-qminimaltoc** introduces indirect reference and hence increases the time that is required to access a global symbol. Another drawback is that the memory requirements for the application might increase. For more information about the performance impact of the option, see “Performance considerations of handling TOC overflow” on page 25.

### Options for enlarging the TOC access range

Enlarging the table of contents (TOC) access range is an effective way to handle TOC overflow. Two instructions are used to access the TOC and group the ranges to consecutive TOC regions. The maximum 16-bit offset on IBM PowerPC supports a large TOC of 64 K TOC regions. With a maximum of 64 K entries in each TOC region, a large TOC can be 4 GB. It creates a limit of 1 G global symbols in a 32-bit environment and 500 M in a 64-bit environment. On POWER8® systems, the two instructions are often executed together in the same time as one.

To enlarge a TOC, you can specify the **-bbigtoc** or **-qplic=large** option. Before you specify the options, reduce the number of TOC entries because a program that contains generated code can result in poor performance.

#### **-bbigtoc**



The **-bbigtoc** option is a linker option of the **-b** flag. It generates extra code if the size of TOC is greater than 64 K. To increase the total TOC capacity, extended TOC regions are created in addition to the base TOC. As a result, the base TOC is the first 64 K region, followed by one or more 64 K regions that form the extended TOC. When the address of a global symbol is placed in the extended TOC, the linker inserts a branch to out-of-line code that contains instructions to compute the location within the extended TOC. The location of the symbol is computed with three instructions: one to locate the extended TOC region, the second to compute the location within the extended TOC, and the third to branch back. When you specify this option, the execution time is increased.

**Note:** The **-bbigtoc** option is a linker option and the code that is produced by the compiler is not changed when the option is specified.

### **-qpic=large**

The **-qpic=large** option works with the linker to generate more efficient code than the **-bbigtoc** option does. When **-qpic=large** is specified, the compiler always generates two instructions to get the address of a symbol, whether TOC overflow occurs or not. When the option is specified, all the symbols, including the symbols in the base TOC, require an extra instruction to compute the addresses. For offsets within the normal 64 KB base TOC size, the linker converts the first instruction to one that does nothing and takes no execution time. On POWER8, these two instructions are often merged into one instruction with a larger displacement. The linker does not insert a branch to out-of-line code for offsets. For more information about how performance is affected by the option, see “Performance considerations of handling TOC overflow.”

**Note:** It is unnecessary to specify **-qpic=large** for each compilation unit.

### **Performance considerations of handling TOC overflow**

Performance must be considered when you handle table of contents (TOC) overflow. When you bypass TOC overflow, minimize any negative effects on runtime performance.

When TOC overflow occurs, the best solution is to reduce the number of global symbols by modifying the source code. You can also consider specifying the following options, depending on performance requirements:

### **-qipa**

- **Advantage:** Applying the interprocedural analysis (IPA) process significantly reduces TOC pressure. In many cases, it completely eliminates TOC overflow. IPA does so by restructuring your program so that the number of global symbols is reduced.
- **Consideration:** IPA is implied at optimization levels **-O4** and **-O5**, but those also include other complex optimizations that are not relevant to commercial application development. One good alternative is **-qipa=level=0**, which applies a minimal level of whole program optimization; however, you might need **-qipa=level=1** for large applications. Level 1 runs a more aggressive reduction of the TOC requirements, at the cost of a longer compilation process.

**Note:** For whole program analysis, you must specify the **-qipa** option at both the compile and link command lines.

### **-qminimaltoc**

- **Advantage:** If the source code contains only performance insensitive global symbols, use **-qminimaltoc** to compile the file. The option places all global symbols in a source file into a separate data structure, which is useful to reduce overall pressure on the TOC.
- **Consideration:** You must specify the option with discretion, particularly with files that contain frequently executed code. The use of the option can significantly affect performance when it is used to compile files that contain performance-sensitive global symbols. When **-qminimaltoc** is specified, the program is larger and slower than it was. However, it is still faster than using the **-bbigtoc** option.

**Note:** You do not need to specify **-qminimaltoc** on all compilation units. Minimize the negative performance by using this option only on compilation units that are not performance relevant.

#### **-bbigtoc**

- **Advantage:** When you specify the option, there is no additional performance cost to access global symbols that are stored in the base TOC.
- **Consideration:** If you specify the **-bbigtoc** option, accessing global symbols in the extended TOC requires more instructions to be executed, including a branch to out-of-line code. The execution time for the sequence of instructions is much more than for the two instructions that are generated by **-qplic=large**, although there is no increased execution time to load pointers within the normal 64 KB base TOC size. In addition, the compiler can miss opportunities to optimize the file because handling the offset calculation is generated at link time.

#### **-qplic=large**

- **Advantage:** The **-qplic=large** option is usually the preferred solution, because it provides the best balance for accessing symbols in both the base and the extended TOC.
- **Consideration:** The option might affect performance because it uses two instructions to get the address of a symbol, regardless of whether TOC overflow occurs. However, the two instructions have only a short latency when compared with the sequence generated by **-bbigtoc**. On POWER8 based system, the two instructions are often executed together in the same time as one.

## Vector technology

Vector technology is a PowerPC technology for accelerating the performance-driven, high-bandwidth communications and computing applications. You can use the vector technology to get dramatic performance improvement for your applications.

There are two ways of using the vector technology: hand coding and automatic vectorization. Automatic vectorization often brings the best performance when you write the code in the right way, but appropriate hand coding can provide additional performance improvement.

The following example shows the difference between a simple array element addition and a vectorized version of the same loop.

Array element addition without using the vector technology:

```
subroutine myadd(n)
  integer :: i, n
  real(4), dimension(n) :: a, b, c
```

```

do i=1, n
  a(i) = b(i) + c(i)
enddo
end subroutine

```

Modified array element addition utilizing the vector technology:

```

subroutine myadd_vector(n)
  integer :: j, n
  ! vector_size is a constant; for real(4) it must be 16/4 = 4
  ! n must be a multiple of vector_size
  vector(real(4), dimension(n/vector_size)) :: v_a, v_b, v_c

  do j=1, n/vector_size
    v_a(j) = vec_add(v_b(j), v_c(j))
  enddo
end subroutine

```

In the vectorized version of the code, the data type is replaced by the vector data type. The loop range is reduced from  $n$  to  $n/\text{vector\_size}$ . With the vector technology, the operation,  $v\_a(j)=\text{vec\_add}(v\_b(j), v\_c(j))$ , is executed in a single machine instruction for each vector. Without the vector technology, the same operation requires multiple instructions costing several processor clock cycles. Therefore, the vector technology can improve the performance of an application.

This section provides general information about vector technology with the following three subsections:

- “Vector technology information”
- “Explicitly calling vector libraries for vectorization” on page 29
- “Auto-vectorization limitations” on page 29

## Vector technology information

This section provides links to all of the information about the vector technology and categorize them into the following types:

- Using vector technology with hand coding
- Using vector technology with auto-vectorization

## Using vector technology with hand coding

The following table lists the information about using the vector technology with hand coding and provides the links to the detailed information in different documents.

*Table 9. Language features for using vector technology with hand coding:*

Information you need	Sections you can read
Intrinsic data types	Vector (IBM extension) in <i>XL Fortran Language Reference</i>
Vector type declaration statement	VECTOR (IBM extension) in <i>XL Fortran Language Reference</i>
Vector intrinsic procedures	Vector intrinsic procedures (IBM extension) in <i>XL Fortran Language Reference</i>
Using the vector libraries	Using the vector libraries

## Using vector technology with auto-vectorization

The following table lists the information about compiler options for auto-vectorization and provides the links to the detailed information in different documents.

*Table 10. Information about compiler options for auto-vectorization*

To do...	Read...
Enable automatic generation of vector instructions for processors that support them.	-qsimd in <i>XL Fortran Compiler Reference</i>
Perform high-order transformations (HOT) during optimization.	-qhot in <i>XL Fortran Compiler Reference</i>
Produce listing files and understand how sections of code have been optimized.	<ul style="list-style-type: none"> <li>• -qlistfmt in <i>XL Fortran Compiler Reference</i></li> <li>• -qreport in</li> <li>• Using compiler reports to diagnose optimization opportunities</li> <li>• Parsing compiler reports with development tools</li> </ul>
Ensure that optimizations done by default, do not alter certain program semantics related to strict IEEE floating-point conformance.	-qstrict in <i>XL Fortran Compiler Reference</i>
Tuning for your target architecture using -qarch and -qtune.	<ul style="list-style-type: none"> <li>• Tuning for your target architecture</li> <li>• Using -qtune</li> </ul>

The following table lists the directive and compiler option that you can use to prohibit auto-vectorization and provides the links to the detailed information in different documents.

*Table 11. Directive and compiler option for auto-vectorization*

To do...	Read...
Prohibit the compiler from auto-vectorizing the loop immediately following the directive.	NOVECTOR in <i>XL Fortran Language Reference</i>
Disable auto-vectorization.	-qsimd in <i>XL Fortran Compiler Reference</i>

Some optimization processes are related to auto-vectorization, you can use compiler options to control these optimizations. The following table lists these optimization processes and provides the links to the detailed information in different documents.

*Table 12. Optimizations related to auto-vectorization*

To learn about...	Read...
The High-order transformation (HOT)	<ul style="list-style-type: none"> <li>• High-order transformation (HOT)</li> <li>• An intermediate step: adding -qhot suboptions at level 3</li> </ul>
The Interprocedural analysis (IPA)	The IPA process

## Explicitly calling vector libraries for vectorization

To use the vector technology in your applications, you can either rewrite the algorithm manually or rely on the automatic vectorization of the compiler. Although automatic vectorization can provide the highest performing solution, proper hand coding can also bring good performance.

The following example shows how to explicitly call the vector libraries to make use of the vector functionality provided by the target hardware.

**Note:** This example requires the POWER7<sup>®</sup> or higher architecture.

```
function dotp(x,y,n) result(s)
  real*8 x(*),y(*),s
  vector(real(8)) sv,xv,yv
  integer i,n

  sv = vec_splats(0.000)
  do i=1,n,2
    xv = vec_xld2(0,x(i))
    yv = vec_xld2(0,y(i))
    sv = vec_madd(xv,yv,sv)
  enddo
  s = vec_extract(sv,0)+vec_extract(sv,1)
  if (mod(n,2) .eq. 1) then
    s = s + x(n)*y(n)
  endif
end function

program dot
  real*8 x(100),y(100),s
  integer i
  do i=1,100
    x(i)=0.5*i
    y(i)=2.0
  enddo
  s = dotp(x,y,100)
  print *,s
end
```

The program performs the dot product for two arrays of REAL. At each iteration, two elements from the arrays are loaded into two REAL vector variables. The program then uses a multiply add operation to calculate the product of the two vectors and add the product with the previous sum. At the end of the loop the two elements of the vector that hold the partial sums are added to form the complete sum value. If the size of the input vectors do not evenly fit in the vector variables, a single scalar product is performed to complete the dot product computation.

## Auto-vectorization limitations

When you use the auto-vectorization, you might find that some transformations cannot be performed. If you compile with `-qhot` and `-qlistfmt=xml=transforms` or `-qlistfmt=xml=all`, you can get a compiler report that lists the reasons why some transformations were not performed. For detailed information about the possible reasons, see [Using compiler reports to diagnose optimization opportunities](#).

This section uses two code examples to illustrate why auto-vectorization cannot be performed under certain situations.

Example 1:

```

program try
  real*8 x(100)
  integer i
  x(1)=9
  do i=2,100
    x(i)=x(i-1)
  enddo
end

```

The  $x(i)=x(i-1)$  statement violates the restriction that "a loop cannot be automatically parallelized if one of its variables carries a dependency".  $x(i)$  and  $x(i-1)$  depend on each other in this sample, which makes the loop non-vectorizable.

Example 2:

```

program try
  real*8 x(100)
  integer i
  do i=1,100,5
    x(i)=i + 8;
    x(i+1)=i + 9;
    x(i+2)=i + 12;
    x(i+3)=i + 15;
  enddo
end

```

The following statements violate the restriction that auto-vectorization cannot be performed if the loop contains a non stride one store.

```

  x(i)=i + 8;
  x(i+1)=i + 9;
  x(i+2)=i + 12;
  x(i+3)=i + 15;

```

In each iteration of the loop, four elements in the array  $x$  are accessed and one element is skipped. This continues until the end of the loop, which makes the loop non-vectorizable.

## Using compiler reports to diagnose optimization opportunities

You can use the `-qlistfmt` option to generate a compiler report in XML or HTML format. It provides information about how your program is optimized. You can also use the `genhtml` utility to convert an existing XML report to HTML format. This information helps you understand your application codes and tune codes for better performance.

The compiler report in XML format can be viewed in a browser that supports XSLT. If you compile with the `stylesheet` suboption, for example, `-qlistfmt=xml=all:stylesheet=x1style.xml`, the report contains a link to a stylesheet that renders the XML readable. By reading the report, you can detect opportunities to further optimize your code. You can also create tools to parse this information.

By default, the name of the report is `a.xml` for XML format, and `a.html` for HTML format. You can use the `-qlistfmt=xml=filename` or `-qlistfmt=html=filename` option to override the default name.

## Inline reports

If you compile with **-qinline** and one of **-qlistfmt=xml=inlines**, **-qlistfmt=html=inlines**, **-qlistfmt=xml**, or **-qlistfmt=html**, the generated compiler report includes a list of inline attempts during compilation. The report also specifies the type of attempt and its outcome.

For each function that the compiler has attempted to inline, there is an indication of whether the inline was successful. The report might contain any number of reasons why a named function has not been successfully inlined. Some examples of these reasons are as follows:

- **FunctionTooBig** - The function is too big to be inlined.
- **RecursiveCall** - The function is not inlined because it is recursive.
- **ProhibitedByUser** - Inlining was not performed because of a user-specified pragma or directive.
- **CallerIsNoopt** - No inlining was performed because the caller was compiled without optimization.
- **WeakAndNotExplicitlyInline** - The calling function is weak and not marked as inline.

For a complete list of the possible reasons, see the **Inline optimization types** section of the XML schema help file named `XMLContent.html` in the `/opt/IBM/xlf/15.1.3/listings/` directory. The Japanese and Chinese versions of the help file, `XMLContent-Japanese.utf8.html` and `XMLContent-Chinese.utf8.html`, are included in this directory as well.

## Loop transformations

If you compile with **-qhot** and one of **-qlistfmt=xml=transforms**, **-qlistfmt=html=transforms**, **-qlistfmt=xml** or **-qlistfmt=html**, the generated compiler report includes a list of the transformations performed on all loops in the file during compilation. The report also lists the reasons why transformations were not performed in some cases:

- Reasons why a loop cannot be automatically parallelized
- Reasons why a loop cannot be unrolled
- Reasons why SIMD vectorization failed

For a complete list of the possible transformation problems, see the **Loop transformation types** section of the XML schema help file named `XMLContent.html` in the `/opt/IBM/xlf/15.1.3/listings/` directory.

## Data reorganizations

If you compile with **-qhot** and one of **-qlistfmt=xml=data**, **-qlistfmt=html=data**, **-qlistfmt=xml**, or **-qlistfmt=html**, the generated compiler report includes a list of data reorganizations performed on the program during compilation. Here are some examples of data reorganizations:

- Array splitting
- Array coalescing
- Array interleaving
- Array transposition
- Common block splitting

- Memory merge

For each of these reorganizations, the report contains details about the name of the data, file names, line numbers, and the region names.

## Profile-directed feedback reports

If you compile with `-qpdf2` and one of `-qlistfmt=xml=pdf`, `-qlistfmt=html=pdf`, `-qlistfmt=xml`, or `-qlistfmt=html`, the generated compiler report includes the following information:

- Loop iteration counts
- Block and call counts
- Cache misses (if compiled with `-qpdf1=level=2`)

**Related information:**



`-qlistfmt`

## Parsing compiler reports with development tools

You can write tools to parse the compiler reports produced in XML format to help you find opportunities to improve application performance.

The compiler includes an XML schema that you can use to create a tool to parse the compiler reports and display aspects of your code that might represent performance improvement opportunities. The schema, `xllisting.xsd`, is located in the `/opt/IBM/xlf/15.1.3/listings/` directory. This schema helps present the information from the report in a tree structure.

You can also find a schema help file named `XMLContent.html` that helps you understand the schema details. The Japanese and Chinese versions of the help file, `XMLContent-Japanese.utf8.html` and `XMLContent-Chinese.utf8.html`, are in the same directory.

---

## Tracing procedures in your code

You can instruct the compiler to insert calls to the tracing procedures that you have defined to aid in debugging or timing the execution of other procedures.

To trace procedures in your program, you must specify which procedures to trace. You must also provide your own tracing procedures. If you enable tracing without providing tracing procedures, you will get linker errors about undefined symbols called `__func_trace_enter`, `__func_trace_exit`, and possibly `__func_trace_catch`.

## Specifying which procedures to trace

The `-qfunctrace` compiler option controls tracing for all non-inlined user-defined procedures and all outlined compiler-generated procedures in your program. If you are interested in tracing specific external or modules procedures, you can use the `-qfunctrace+` and `-qfunctrace-` compiler options. You can also specify the `NOFUNCTRACE` directive to disable the tracing of entire modules, external procedures, module procedures, or internal procedures.

## What can be traced

Tracing applies to programs, external procedures, non-intrinsic module procedures, and internal procedures.



Compiler-generated procedures are not traced unless they were generated for outlined user code, such as an OpenMP program. In those cases, the name of the outlined procedure contains the name of the original user procedure as a prefix.

Inlined procedures and statement functions cannot be traced because they do not exist in the executable.

To avoid infinite recursion, user-defined tracing procedures cannot be traced. Similarly, tracing must be disabled for procedures called from user-defined tracing procedures.

## How to write tracing procedures

You can implement the tracing procedures in Fortran, C, or C++.

To implement the tracing procedures in Fortran, the characteristics of the procedures must be the same as those specified in the following interface:

```
SUBROUTINE routine_name(procedure_name, file_name, line_number, id)
  USE, INTRINSIC :: iso_c_binding
  CHARACTER(*), INTENT(IN) :: procedure_name
  CHARACTER(*), INTENT(IN) :: file_name
  INTEGER(C_INT), INTENT(IN) :: line_number
  TYPE(C_PTR), INTENT(INOUT) :: id
END SUBROUTINE
```

where `routine_name` is the name of an external or module procedure.

You must then tell the compiler to use your subroutine as a tracing procedure in one of the following ways:

- Using the `-qfunctrace_xlf_enter`, `-qfunctrace_xlf_exit`, or `-qfunctrace_xlf_catch` compiler options.
- Using the `FUNCTRACE_XLF_ENTER`, `FUNCTRACE_XLF_EXIT`, or `FUNCTRACE_XLF_CATCH` directives.

When you specify these options or directives, XL Fortran generates wrapper procedures called `__func_trace_enter`, `__func_trace_exit`, and `__func_trace_catch` that call your corresponding tracing procedure. These wrappers allow interoperability with C and C++ by converting the dummy arguments from the C prototype to the interface described earlier. `routine_name` must therefore not be named `__func_trace_enter`, `__func_trace_exit`, or `__func_trace_catch`. In addition, your program must not contain more than one of each of the tracing procedures.

Writing the tracing procedures in C or C++ requires that you provide the `__func_trace_enter`, `__func_trace_exit`, and `__func_trace_catch` procedures directly. They must have the following prototypes:

- `void __func_trace_enter(const char *const procedure_name, const char *const file_name, int line_number, void **const id);`
- `void __func_trace_exit(const char *const procedure_name, const char *const file_name, int line_number, void **const id);`
- `void __func_trace_catch(const char *const procedure_name, const char *const file_name, int line_number, void **const id);`

**Note:** If you write the tracing procedures in C++, they must be declared extern "C".

XL Fortran inserts calls to your tracing procedures on procedure entry and exit. It passes the name of the procedure being traced, the name of the file containing the entry or exit point being traced, and the line number. It also passes the address of a static pointer that is initialized to `C_NULL_PTR` at the beginning of the program. This pointer allows you to store arbitrary data in the entry tracing procedure and access this data in the exit and catch procedures. See the Examples section for detail. Because this pointer resides in static memory, extra steps might be needed when tracing threaded or recursive procedures.

## Sample tracing procedures

XL Fortran provides sample tracing procedures in the `/opt/IBM/xlf/15.1.0/samples/functrace` directory. You can use these procedures for simple tracing, or you can modify them for more complex tracing.

- `tracing_routines.c`: Provides tracing procedures written in C. This file is useful when you do not require access to Fortran modules, and when there is a possibility of recursive input / output.
- `tracing_routines.f90`: Provides tracing procedures written in Fortran. This file is useful when you need access to Fortran modules or intrinsics in your tracing procedures.

The following example illustrates the use of the samples for simple tracing:

```
> cat helloworld.f
print *, 'hello world'
end
> cc -c /opt/IBM/xlf/15.1.0/samples/functrace/tracing_routines.c
> xlf95 helloworld.f -qfunctrace tracing_routines.o
** _main === End of Compilation 1 ===
1501-510 Compilation successful for file helloworld.f.
> ./a.out
{ _main (helloworld.f:1)
  hello world
} _main (helloworld.f:2)

>
```

## Tracing limitations

The procedure tracing functionality has the following limitations:

- A procedure cannot be traced separately from its **ENTRY** points. Either all are traced or none are. The name of the procedure is passed to the tracing procedure even when tracing the **ENTRY** point. The line number helps distinguish what is being traced in this case.
- The Fortran standard requires pure procedures to have no side effects. The compiler uses this assumption when optimizing your program. If you enable tracing of a pure procedure, your tracing procedure must not change the program state in a way that creates a side effect.
- The Fortran standard imposes limits on recursive input/output. If you write your tracing procedures in Fortran, you must be careful not to break these rules.

The following example has a print statement where an I/O item is the result of a function call (`foo`). It is illegal for the tracing procedure in this case to have I/O on an external file:

```
> cat recursive.f
integer function test()
  test = 1
end function
```

```

integer test
print *, test() ! test must not have I/O on external unit
end
> xlf95 -c /opt/IBM/xlf/15.1.0/samples/functrace/tracing_routines.f90
** my_func_trace_enter   === End of Compilation 1 ===
** my_func_trace_exit    === End of Compilation 2 ===
** my_func_trace_catch   === End of Compilation 3 ===
1501-510 Compilation successful for file tracing_routines.f90.
> xlf95 recursive.f tracing_routines.o -qfunctrace
** test   === End of Compilation 1 ===
** _main  === End of Compilation 2 ===
1501-510 Compilation successful for file recursive.f.
> ./a.out
{ _main (recursive.f:6)
XL Fortran (I/O initialization): I/O recursion detected.
IOT/Abort trap
>

```

**Note:** You can work around this by writing the tracing procedure in C. For an example, see the `tracing_routines.c` sample file described in section “Sample tracing procedures” on page 34.

- When optimizing your program, the compiler reorders code and removes dead code. As a result, the line number passed to the tracing procedure might not be accurate when optimization is enabled.

## Examples

In the following example, `-qfunctrace` is used to measure the time spent in each external procedure. The `FUNCTRACE_XLF_ENTER` and `FUNCTRACE_XLF_EXIT` directives are used to specify procedures `my_enter` and `my_exit` as the tracing procedures. The `NOFUNCTRACE` directive is used to disable tracing of `main_program`:

```

> cat example.f
! Designate my_enter as a tracing procedure that should be called
! on procedure entry
!ibm* functrace_xlf_enter
subroutine my_enter(procedure_name, file_name, line_number, id)
  use, intrinsic :: iso_c_binding
  use, intrinsic :: xlfutility
  character(*), intent(in) :: procedure_name, file_name
  integer(c_int), intent(in) :: line_number
  type(c_ptr), intent(inout) :: id

  integer(kind=time_size), pointer :: enter_count

  ! Store the time we entered the procedure being traced into id.
  if (.not. c_associated(id)) then
    allocate(enter_count)
    enter_count = time_()
    id = c_loc(enter_count)
  end if

  print *, 'Entered procedure ', procedure_name, ' at ( ', &
    file_name, ' : ', line_number, ').'
end subroutine

! Designate my_exit as a tracing procedure that should be called
! on procedure exit
!ibm* functrace_xlf_exit
subroutine my_exit(procedure_name, file_name, line_number, id)
  use, intrinsic :: iso_c_binding
  use, intrinsic :: xlfutility
  character(*), intent(in) :: procedure_name, file_name

```

```

integer(c_int), intent(in) :: line_number
type(c_ptr), intent(inout) :: id

integer(kind=time_size), pointer :: enter_count
integer(kind=time_size) exit_count, duration

! id should have been associated in my_enter with the time we
! entered the procedure being traced. Find the elapsed time.
if (c_associated(id)) then
  exit_count = time_()
  call c_f_pointer(id, enter_count)
  duration = exit_count - enter_count
else
  stop "error!"
endif

print *, 'Leaving procedure ', procedure_name, ' at ( ', &
        file_name, ' : ', line_number, ').'
print *, 'Spent', duration, 'seconds in ', procedure_name, '.'
end subroutine

! sub2 will be traced
subroutine sub2
  call sleep_(3)
end subroutine

! sub1 will be traced
subroutine sub1
  call sleep_(5)
  call sub2
end subroutine

! Do not want to trace main_program
!ibm* nofunctrace
program main_program
  call sub1
end program
> xlf95 example.f -qfunctrace
** my_enter   === End of Compilation 1 ===
** my_exit    === End of Compilation 2 ===
** sub2       === End of Compilation 3 ===
** sub1       === End of Compilation 4 ===
** main_program === End of Compilation 5 ===
1501-510 Compilation successful for file example.f.
> ./a.out
Entered procedure sub1 at ( example.f : 59 ).
Entered procedure sub2 at ( example.f : 54 ).
Leaving procedure sub2 at ( example.f : 55 ).
Spent 3 seconds in sub2.
Leaving procedure sub1 at ( example.f : 61 ).
Spent 8 seconds in sub1.
>

```

## Related information

- For details about the **-qfunctrace** compiler option, see **-qfunctrace** in the *XL Fortran Compiler Reference*.
- For details about **-qfunctrace\_xlf\_catch**, **-qfunctrace\_xlf\_enter**, or **-qfunctrace\_xlf\_exit** compiler options, see the Detailed descriptions of the XL Fortran compiler options section in the *XL Fortran Compiler Reference*.
- For details about the **FUNCTRACE\_XLF\_CATCH**, **FUNCTRACE\_XLF\_ENTER**, and **FUNCTRACE\_XLF\_EXIT** directives, see Detailed directive descriptions section in the *XL Fortran Language Reference*.
- For details about the **NOFUNCTRACE** directive, see **NOFUNCTRACE** in the *XL Fortran Language Reference*.

---

## Getting more performance

The XL compiler family offers other strategies and tuning alternatives for increasing performance.

Whether you are already optimizing at **-O5**, or you are looking for more opportunities to increase performance without the resource costs of optimizing at higher levels, the XL compiler family offers other strategies and tuning alternatives. For more information, see the following topics:

- Tuning XL compiler applications
- Advanced optimization concepts
- Optimizing your SMP code

---

## Beyond performance: effective programming techniques

Applications that perform well begin with applications that are written well. See the following topics for information about writing better code; whether your goal is to make your code more portable, more easily optimized, or interoperable with other languages.

- Chapter 4, “Managing code size,” on page 53
- Chapter 6, “Compiler-friendly programming techniques,” on page 65
- Chapter 8, “Parallel programming with XL Fortran,” on page 89
- Chapter 9, “Interlanguage calls,” on page 265



---

## Chapter 2. Tuning XL compiler applications

Included as part of the XL Fortran optimization suite are options you can use to instruct the compiler to generate code that executes optimally on a given processor or architecture family, and to instruct the compiler on the execution characteristics of your application.

The better you can convey those characteristics, the more precisely the compiler can tune and optimize your application. This section assumes that you have already begun optimizing your application using the strategies found in *Optimizing your applications*.

---

### Tuning for your target architecture

By default, the compiler generates code that runs on all supported systems, though this code does not run optimally on all supported systems. By selecting options to target the appropriate architectures, you can optimize your application to suit the broadest possible selection of relevant processors, a range of processors within a given family, or a specific processor.

The compiler options in the *Options for targeting your architecture* table introduce how you can control optimizations affecting individual aspects of your target architecture. This section also goes into further detail on how you can use some of those options to ensure your application provides the best possible performance on those targets.

Table 13. Options for targeting your architecture

Option	Behavior
<b>-q32</b>	Generates code for a 32-bit addressing model (32-bit execution mode).
<b>-q64</b>	Generates code for a 64-bit addressing model (64-bit execution mode).
<b>-qarch</b>	Selects a family of processor architectures, or a specific architecture that the compiler will generate machine instructions for. If you specify multiple architecture settings, only the last architecture is considered valid.
<b>-qtune</b>	Focuses optimizations for execution on a given processor without restricting the processor architectures that your application can execute on. If you specify multiple architecture settings, only the last architecture is considered valid. You can also use <b>-qtune</b> to specify the processor SMT level that the program will execute on.
<b>-qcache</b>	Defines a specific cache or memory geometry. Selecting a predefined optimization level like <b>-O2</b> sets default values for <b>-qcache</b> suboptions.

In addition to targeting the correct architecture for your application, it is important to select the right level of optimization. Combining the appropriate architecture settings with an optimization level that fits your application can vastly enhance performance. If you have not already done so, consult *Optimizing your applications* in addition to this section.

## Using `-qarch`

Using `-qarch` you can select a machine architecture or a family of architectures on which you can run your application. Selecting the correct `-qarch` suboption is crucial to influencing chip-level optimization as the choice of `-qarch` suboption controls:

- The list of machine instructions available to the compiler when generating object code.
- The characteristics and capabilities of the hardware the compiler will model when optimizing.
- Optimization trade-offs and opportunities in individual instruction selection and instruction sequence selection
- The default setting of the `-qtune` option.

Architecture selection is important at all optimization levels. Even at low optimization levels like `-O0` and `-O2`, specifying the correct target architecture can be beneficial to performance. Specifying the correct target allows the compiler to select more efficient machine instructions and generate instruction sequences that perform best for a particular machine.

The `-qarch` suboptions allow you to specify individual processors or a family of processors with common instruction sets or subsets. The choice of processor gives you the flexibility of compiling your application to execute optimally on a particular machine, or to execute on a wide variety of machines while still applying as much architecture-specific optimization as possible. The less specific your choice of architecture, the fewer machine instructions available to the compiler when generating code. A less specific choice can also limit the number of hardware intrinsic functions available to your application. A more specific choice of architecture, can make available more instructions and hardware intrinsic functions. The *XL Fortran Compiler Reference* details the specific chip architectures and architecture families available.

When compiling your application, using a consistent or compatible `-qarch` setting for all files will ensure that you are getting the most from your architecture targets. If you are using `-qipa` link-time optimizations, the architecture setting you specify on the link step overrides the compile step setting.

You must ensure that your application executes only on machines that support your `-qarch` settings. Executing your application on other machines can produce incorrect results, even if your application appears to run without trapping. In some cases, `-qarch` suboptions are both individual targets and family targets because the instruction set of newer chips is a superset of the instruction set that earlier chips support. For example, the `-qarch=pwr5` setting can also safely target POWER5, POWER6®, POWER7, and POWER8 systems because those processors support the complete base POWER5 instruction set.

### Choosing the best `-qarch` suboption

If your application executes on a single type of processor, use the `-qarch` setting matching your target processor. If your application will run on multiple processor types, choose a `-qarch` setting with the largest common intersection of all the processors. You can do this by examining the instruction groups available to the processors and choosing a family setting that best represents it. The following table can assist you with that choice.

**Note:** Not all the XL compilers support all the architectures.



Table 14. Instruction groups for a supported architecture

-qarch suboption	PowerPC	Graphics	Sqrt	64-bit	PWR3	PWR4	PWR5	Vector	PWR6 architected	PWR6 raw
pwr4 chip and family	X	X	X	X	X	X				
pwr5 chip and family	X	X	X	X	X	X	X			
pwr5x chip	X	X	X	X	X	X	X			
ppc64v family	X	X	X	X	X	X		VMX		
ppc970 chip	X	X	X	X	X	X		VMX		
pwr6 and family	X	X	X	X	X	X	X	VMX	X	
pwr6e	X	X	X	X	X	X	X	VMX	X	X
pwr7	X	X	X	X	X	X	X	VMX, VSX	X	
pwr8	X	X	X	X	X	X	X	VMX, VSX	X	

### Unsupported architectures

The *Instruction groups for an unsupported architecture* table lists architectures that the compiler no longer supports. Although the compiler still recognizes and generates code for these architectures, the particular behaviors for these settings that previous versions of the compiler support can differ in some instances. Use with discretion.

Table 15. Instruction groups for an unsupported architecture

-qarch suboption	Available instructions								
	PWR2	PowerPC	Graphics	Sqrt	64-bit	PWR3	PWR4	PWR5	Vector
ppc		X							
ppcgr		X	X						
ppc64		X			X				
ppc64gr		X	X		X				
ppc64grsq		X	X	X	X				

Using the default value for **-qarch** represents the broadest possible range of machines that the compiler supports. For example, in 32-bit mode, the architecture defaults to a setting of pwr4. If you know that your code will only execute on POWER5 or newer machines, avoid the default **-qarch** setting and choose at least PWR5.

### Other options and -qarch

Other compiler options can influence the suboption selection for **-qarch**. The **-q64** option forces an upgrade of the **-qarch** suboption to the minimum chip level that can support 64-bit instructions. For example, the setting is PPC64. The **-qarch=auto** suboption is selected automatically when you compile at **-04** and **-05**, and assumes that your compilation machine and your target execution machine are the same. For example, if you compile on a POWER5-based system and specify **-05**, the

**-qarch** setting defaults to PWR5. You can override this behavior by specifying the **-qarch** option after the **-O4** or **-O5** compiler options.

## Using **-qtune**

The **-qtune** option focuses optimizations for execution on a given processor without restricting the processor architectures that your application can execute on, generating machine instructions consistent with your **-qarch** architecture choice. Using **-qtune** also guides the optimizer in performing transformations, such as instruction scheduling, so that the resulting code executes most efficiently on your chosen **-qtune** architecture. The **-qtune** option tunes code to run on one particular processor architecture, and includes only specific processors as suboptions. The **-qtune** option does not support suboptions representing families of processors.

Use **-qtune** to specify the most common or critical processor where your application executes. For example, if your application usually executes on POWER8 based systems but will sometimes execute on a POWER7 based system, specify **-qarch=pwr7 -qtune=pwr8**. The compiler generates code that executes more efficiently on a POWER8 based system but will still run correctly on a POWER7 based system.

The default **-qtune** setting depends on the **-qarch** setting. If the **-qarch** option is set to a particular machine architecture, this limits the range of available **-qtune** suboptions, and the default tune setting will be compatible with the selected target processor. If **-qarch** option is set to a family of processors, the range of values available for **-qtune** expands across that family, and the default is chosen from a commonly used machine in that family. If you compile with **-qtune=auto**, the default for optimization levels **-O4** and **-O5**, the compiler detects the machine characteristics on which you are compiling, and assumes you want to tune for that type of machine. You can override this behavior by specifying **-qtune** after the **-O4** or **-O5** compiler options.

If you need to create a single binary file that runs on a range of PowerPC hardware, consider using the **-qtune=balanced** option. With this option in effect, optimization decisions made by the compiler are not targeted to a specific version of hardware. Instead, tuning decisions try to include features that are generally helpful across a broad range of hardware and avoid those optimizations that may be harmful on some hardware. Note that you should verify the performance of code compiled with the **-qtune=balanced** option before distributing it.

For POWER8 processors, you can also use **-qtune** to specify the processor SMT level that the program will execute on.

You can also use **-qtune** to specify the processor SMT level that the program will execute on.

## Using **-qcache**

The **-qcache** option allows you to instruct the optimizer on the memory cache layout of your target architecture. There are several suboptions you can specify to describe cache characteristics such as:

- The types of cache available
- The cache size
- Cache-miss penalties

The **-qcache** option is only effective if you understand the cache characteristics of the execution environment of your application. Before using **-qcache**, look at the

options section of the listing file with the **-qlist** option to see if the current cache settings are acceptable. The settings appear in the listing when you compile with **-qlistopt**. If you are unsure about how to interpret this information, do not use **-qcache**, and allow the compiler to use default cache settings.

If you do not specify **-qcache**, the compiler makes cache assumptions based on your **-qarch** and **-qtune** settings. If you compile with the **-qcache=auto** suboption, the default at optimization levels **-O4** and **-O5**, the compiler detects the cache characteristics of your compilation machine and tunes cache optimizations for that cache layout. If you do specify **-qcache**, also specify **-qhot**, or an option such as **-O4** that implies **-qhot**. The optimizations that **-qhot** performs are designed to take advantage of your **-qcache** settings.

## Before you finish tuning

Consult the following list to ensure that you are getting the most out of your target machine options.

- Do not specify a **-qarch** option that is incompatible with your hardware. This can produce unexpected results.
- Specify a **-qarch** setting that represents the largest common instruction set available to the machines that your application will execute on. Consult the *Instruction group support by architecture* table for more information.
- If you are executing your application on multiple machines, choose the **-qtune** suboption that aligns with the machine you expect your application to run on most frequently or where performance is most important.
- If compiling with **-qcache**, specify **-qhot** as well, which can take advantage of your cache settings.

---

## Further option driven tuning

You can use options to convey the characteristics of your application to the compiler, tuning the optimizations that the compiler will apply. Option driven tuning is a process that can require experimentation to find the right combination of options to increase the performance of your application.

The XL compilers support many options that allow you to assert that your application will not follow certain standard language rules in some instances. The compiler assumes language standard compliance and can perform unsafe optimizations if your application is not compliant. Standards-conforming applications are more easily optimized and more portable, but when full compliance is not possible, use the appropriate options to ensure your code is optimized safely.

For complete compiler option syntax, see the *XL Fortran Compiler Reference*.

## Options for providing application characteristics

This section provides a list of options that can dictate a wide variety of characteristics about your application to the compiler including floating-point and loop behaviors.

### Option Description

#### **-qalias**

Supports several suboptions that can help the compiler analyze the characteristics of your application. For more information on aliasing, see Advanced optimization concepts.

- noaryovrlp**  
Asserts that your application contains no array assignments between storage associated (overlapping) arrays.
- nointptr**  
Asserts that your application does not make use of integer (Cray) pointers.
- nopteovrlp**  
Asserts that your application does not contain pointee variables that refer to any data objects that are not pointee variables. Also, that your application does not contain two pointee variables that can refer to the same storage location.
- std** Asserts that your application follows all language rules for variable aliasing. This is the default compiler setting. Specify **-qalias=nostd** if your application does not follow all variable aliasing rules.
- qassert**  
Includes the following suboptions that can be useful for providing some loop characteristics of your application.
- nodeps**  
Asserts that the loops in your application do not contain loop carried dependencies.
- itercnt=*number***  
Gives the optimizer a value to use when estimating the number of iterations for loops where it cannot determine that value.
- qddim**  
Forces the compiler to reevaluate the bounds of a pointee array each time the application references the array. Specify this option only if your application performs dynamic dimensioning of pointee arrays.
- qdirectstorage**  
Asserts that your application accesses write-through-enabled or cache-inhibited storage.
- qfloat**  
Provides the compiler with floating-point characteristics for your application. The following suboptions are particularly useful.
- nans** Asserts that your application makes use of signaling NaN (not-a-number) floating-point values. Normal floating-point operations do not create these values, your application must create signalling NaNs.
- rrm** Prohibits optimization transformations that assume the floating-point rounding mode must be the default setting round-to-nearest. If your application changes the rounding mode in any way, specify this option.
- qflttrap**  
Controls various aspects of floating-point exception handling that your application can require if it attempts to detect or handle such exceptions. If your application enables floating point trapping without using **-qflttrap**, you must use the **-qfloat=fenv** option.
- qieee** Specifies the floating-point rounding mode when evaluating expressions at compile time. This option is important if your application requires a

non-default rounding mode in order to have consistency between compile-time evaluation and runtime evaluation.

You can also specify **-y** to set the compile-time floating-point rounding mode.

**-qlargepage**

Indicates that your application is designed to execute in the AIX 16 MB large page memory environment.

**-qlibansi**

Asserts that any external function calls in your compilation that have the same name as standard C library function calls, such as malloc or memcpy, are in fact those functions and are not a user-written function with that name.

**-qlibessl**

Asserts that your application will be linked with IBM's ESSL high-performance mathematical library and that mathematical operations can be transformed into calls to that library. For more information on ESSL, see the High performance libraries topic.

**-qlibmpi**

Asserts that all functions with Message Passing Interface (MPI) names are in fact MPI functions and not a user function with different semantics.

**-qlibposix**

Asserts that any external function calls in your application that have the same name as standard Posix library function calls are in fact those functions and are not a user-written function with that name.

**-qonetrip**

Asserts that all DO loops in your application will execute at least one iteration. You can also specify this behavior with **-1**.

**-qnostrictieemod**

Relaxes certain rules required by the Fortran 2003 standard related to the use of the IEEE intrinsic modules. Specify this option if your application does not use these modules.

**-qstrict\_induction**

Prevents optimization transformations that would be unsafe if DO loop integer iteration count variables overflow and become negative. Few applications contain algorithms that require this option.

**-qthreaded**

Informs the compiler that your application will execute in a multithreaded/SMP environment. Using an **\_r** invocation, like **xlf\_r**, adds this option automatically.

**-qnounwind**

Informs the compiler that the stack will not be unwound while any routine in your application is active. The **-qnounwind** option enables prologue tailoring optimization, which reduces the number of saves and restores of nonvolatile registers.

**-qnozerosize**

Asserts that this application does not require checking for zero-sized arrays when performing array operations.

## Options to control optimization transformations

There are many options available to you in addition to the base set found in the Optimizing your applications section. Some of these options prevent an optimization that can be unsafe for certain applications or enable one that is safe for your application, but is not normally available as part of the optimization process.

### Option Description

#### **-qcompact**

Chooses a reduction of final code size over a reduction in execution time. You can use this option to constrain the optimizations of **-O2** and higher. For more information on restriction code size, see the Managing code size section.

**-qfdpr** Prepares your object code for additional optimization by the FDPR<sup>®</sup> object code optimizer.

#### **-qsimd=auto**

Makes use of the vector capabilities of processors such as POWER7.

#### **-qfloat**

This option provides a number of suboptions for controlling the optimizations to your floating-point calculations.

##### **norsqrt**

Prevents the replacement of the division of the result of a square-root calculation with a multiplication by the reciprocal of the square root.

##### **nostrictmaf**

Prevents certain floating-point multiply-and-add instructions where the sign of signed zero value would not be preserved and rounding is in the wrong direction.

**-qipa** Includes many suboptions that can assist the IPA optimizations while analyzing your application. If you are using the **-qipa** option or higher optimization levels that imply IPA, it is to your benefit to examine the suboptions available.

#### **-qmaxmem**

Limits the memory available to certain memory-intensive optimizations at low levels. Specify **-qmaxmem=-1** to remove these memory limits.

#### **-qnoprefetch**

Prevents the insertion of prefetching machine instructions into your application during optimization.

#### **-qinline**

Exerts control over inlining optimization transformations. For more information on inlining, see the Advanced optimization concepts section.

#### **-qsmallstack**

Instructs the compiler to limit the use of stack storage in your application. This can increase heap usage.

#### **-qsmp**

Produces code for an SMP system. This option also searches for opportunities to increase performance by automatically parallelizing your code. The Parallel programming with XL Fortran section contains more information on writing parallel code.

**-qstacktemp**

Limits certain compiler temporaries allocated on the stack. Those not allocated on the stack will be allocated on the heap. This option is useful for applications that use enough stack space to exceed stack user or system limits.

**-qstrict**

Limits optimizations to strict adherence to implied program semantics. This often prevents the compiler from ignoring certain little-used rules in the IEEE floating-point specification that few applications require for correct behavior. For example, reordering or reassociating a sequence of floating-point calculations can cause floating-point exceptions at an unexpected location or mask them completely. The **-qstrict** option includes suboptions that refine the control of the transformations performed by the optimizers. Do not use this option unless your application requires strict adherence as **-qstrict** and its suboptions can severely inhibit optimization.

**-qunroll**

Independently controls loop unrolling. At **-O3** and higher, **-qunroll** is a default setting.

## Options to assist with performance analysis

The compiler provides a set of options that can help you analyze the performance aspects of your application. These options are most useful when you are selecting your level of optimization and tuning the optimization process to the particular characteristics of your application.

**-d** Informs the compiler that you want to preserve the preprocessed versions of your compilation files. Typically these files would have a **.F** extension.

**-g** Inserts debugging information into your object code. You can use different **-g** levels to balance between debug capability and compiler optimization.

**-p** Inserts appropriate profiling information into your object code to make using tools for performance analysis possible. You can also specify this behavior with **-pg**.

**-qlinedebug**

An option similar to **-g**, this option inserts only minimal debugging information into your object code such as function names and line number information.

**-qlist** Produces a listing file containing a pseudo-assembly listing of your object code.

**-qlistfmt**

Creates a compiler report to assist with finding optimization opportunities.

**-qreport**

Inserts information in the listing file showing the transformations done by certain optimizations.

**-S** Produces a **.s** file containing the assembly version of the **.o** file produced by the compilation.

**-qshowpdf**

Enables the optimization process to insert additional profiling information into the compiled application. You can use the **showpdf** utility to view

part of the profiling information of your application in text or XML format. For more information about profile-directed feedback (PDF), see Profile-directed feedback.

**-qtbtable**

Limits the amount of debugging traceback information in object files, which reduces the size of the program. Use **-qtbtable=full** if you intend to analyze your application with the **tprof** profiling utility.

## Options that can inhibit performance

Some compiler options are necessary for some applications to produce correct or repeatable results. Usually, these options instruct the compiler to enforce very strict language semantics that few applications require. Others are supported by the compiler to allow compilation of code that does not conform to language standards. Avoid these options if you are trying to increase the runtime performance of your application. In cases where these options are enabled by default, you must disable them to increase performance. You can specify **-qlistopt** to show, in the listing file, the settings of each of these options.

The following list summarizes the options that can inhibit performance. Each option is described in the *XL Fortran Compiler Reference*.

- -qalias=nostd
- -qcompact
- -qfloat=nosqrt, -qfloat=nostrictmaf, -qfloat=rrm
- -qsimd=noauto
- -qnoprefetch
- -qnounroll
- -qsmallstack
- -qstacktemp=[value other than 0 or -1]
- -qstrict
- -qstrict\_induction
- -qstrictieemod
- -qunwind
- -qxf2008=checkpresence
- -qzerosize
- -qnoinline



---

## Chapter 3. Advanced optimization concepts

After you apply command-line optimizations and tuning that are appropriate to your application and the constraints of your development cycle, you have opportunities to further improve the performance of your application through aliasing and inlining.

---

### Aliasing

An alias occurs when different variables point directly or indirectly to a single area of storage. Aliasing refers to assumptions made during optimization about which variables can point to or occupy the same storage area.

When an alias exists, or the potential for an alias occurs during the optimization process, pessimistic aliasing occurs. This can inhibit optimizations like dead store elimination and loop transformations on aliased variables. Also, pessimistic aliasing can generate additional loads and stores as the compiler must ensure that any changes to the variable that occur through the alias are not lost.

When aliasing occurs there is less opportunity for optimization transformations to occur on and around aliased variables than variables where no aliasing has taken place. For example, if variables *A*, *B*, and *C* are all aliased, any optimization must assume that a store into or a use of *A* is also a store or a use of *B* and *C*, even if that is not the case. Some of the highest optimization levels can improve alias analysis and remove some pessimistic aliases. However, in all cases, when it is not proven during an optimization transformation that an alias can be removed that alias must be left in place.

Where possible, avoid programming techniques that lead to pessimistic aliasing assumptions. These aliasing assumptions are the single most limiting factor to optimization transformations. The following situations can lead to pessimistic aliasing:

- When you assign a pointer the address of any variable, the pointer can be aliased with globally visible variables and with static variables visible in the pointer's scope.
- When you call a procedure that has dummy arguments passed by reference, aliasing occurs for variables used as actual arguments, and for global variables.
- The compiler will make several worst-case aliasing assumptions concerning variables in common blocks and modules. These assumptions can inhibit optimization.

Some compiler options like `-qalias` can affect aliasing directly. For more information on how to tune the aliasing behavior in your application, see “Options for providing application characteristics” on page 43.

---

### Inlining

Inlining is the process of replacing a subroutine or function call at the call site with the body of the subroutine or function being called. This eliminates call-linkage overhead and can expose significant optimization opportunities.

For example, with inlining, the compiler can replace the subroutine parameters in the function body with the actual arguments passed. Inlining trade-offs can include code bloat and an increase in the difficulty of debugging your source code.

If your application contains many calls to small procedures, the procedure call overhead can sometimes increase the execution time of the application considerably. Specifying the **-qinline** compiler option can reduce this overhead. Additionally, you can use the **-p** or **-pg** options and profiling tools to determine which subprograms your application calls most frequently, and use **-qinline** to list their names to ensure inlining.

The **-qinline** option can perform inlining where the calling and called procedures are in different compilation units. This applies to optimization level **-O5** only.

```
# Let the compiler decide what to inline.
xlf95 -O3 -qinline inline.f

# Encourage the compiler to inline particular subprograms.
xlf95 -O3 -qinline+called_100_times:called_1000_times inline.f
```

**Note:** **-qipa=inline** is deprecated and no longer supported; it is replaced by **-qinline**. For details, see the *Deprecated options* section in the *XL Fortran Compiler Reference*.

## Finding the right level of inlining

A common occurrence in application optimization is excessive inlining. This can actually lead to a decrease in performance because running larger programs can cause more frequent cache misses and page faults. Because the XL compilers contain safeguards to prevent excessive inlining, this can lead to situations where subprograms you want to inline are not automatically inlined when you specify **-qinline**.

Some common conditions that prevent **-qinline** from inlining particular subprograms are:

- The calling and called procedures are in different compilation units. If so, you can use the **-qinline** option in the link step to enable cross-file inlining. This applies to optimization level **-O5** only.
- After inlining expands a subprogram to a particular limit, the optimizer does not inline subsequent calls to that subprogram.
- Any interface errors, such as different numbers, sizes, or types of arguments or return values, can prevent inlining for a subprogram call. On AIX you can also compile with the **-qextchk** option to locate these errors. You can also use interface blocks for the procedures being called.
- Actual or potential aliasing of dummy arguments or automatic variables can limit inlining. Consider the following cases:
  - There are more than 31 arguments to the procedure your application is calling.
  - Any automatic variables in the called procedures are involved in an **EQUIVALENCE** statement
  - The same variable argument is passed more than once in the same call. For example, `CALL SUB(X,Y,X)`.
- Some procedures that use computed **GO TO** statements, where any of the corresponding statement labels are also used in an **ASSIGN** statement.

To change the size limits that control inlining, you can specify **-qinline=level=*n***, where *n* is 0 through 10. Larger values allow more inlining.

It is possible to inline C/C++ functions into Fortran programs and Fortran functions into C/C++ programs during link time optimizations. You must compile the C/C++ code using the IBM XL C/C++ compilers with **-qinline** and a compatible option set to that used in the IBM XL Fortran compilation.



---

## Chapter 4. Managing code size

Code size is often not a detriment to performance for most XL compiler programmers. For some however, generating compact object code can be as important as generating efficient code.

Oversized programs can affect overall performance by creating a conflict for real storage between pages of virtual storage containing code, and pages of virtual storage containing data. On systems with a small, combined instruction and data cache, cache collisions between code and data can also reduce performance. This section provides suggestions on how to achieve a balance between code efficiency and object-module size, while identifying compiler options that can affect object-module size. Code size tuning is most effective once you have built a stable application and run optimization at **-O2** or higher.

Reasons for tuning for code size include:

- Your application design calls for an implementation with limited real memory, instruction-cache space, or disk space.
- When loading your application, it uses enough memory to create a conflict between code areas and data areas in real memory, and both code and data are frequently paged in and out.
- There are high activity areas in your code large enough that instruction cache and instruction Translation Lookaside Buffer (TLB) misses have a major effect on performance.
- You intend your application to run on a host that serves end users, or in a batch environment with limits on real memory.

Before tuning for code size, it is important for you to determine whether code size is the actual problem. Very large applications tend to have small clusters of high activity and large sections of infrequently accessed code. If a particular code page is not accessed in a particular run, that page is never loaded into memory, and has no negative impact on performance. If you are tuning for code size due to the high activity code segments that cause instruction cache and instruction TLB misses that have a major effect on performance, this can be symptomatic of a program structure that requires improvement or hardware not suited to the resource requirements of the application.

If your data takes up more real storage than is available, reducing code size can improve performance by ensuring that fewer pages of data are paged out as code is paged in. However, data blocking strategies are likely to prove both more effective and easier to implement. Processing data in each page as completely as possible before moving on to the next page can reduce the number of data page misses.

If you are coding an application for a machine with a combined instruction and data cache, you can improve performance by applying the techniques described later in this section, but tuning for data cache management can yield better results than code-size tuning. Also note that highly tuning your code for the cache characteristics of one system can lead to undesirable performance results if you execute your application elsewhere.

---

## Steps for reducing code size

Reducing the code size of your application can have a positive effect on the performance of your application

Consider the following steps for reducing code size:

- Ensure that you have built a stable application that compiles at **-O2** or higher.
- Use performance analysis tools to isolate high activity code segments and tune for performance where appropriate. Basing decisions for code size tuning on an application that has already undergone performance analysis will give you more information on where your application could benefit from code size tuning.
- Use compiler options like **-qcompact** to help reduce code size. See Compiler option influences on code size for more information. Also see the following options in the *XL Fortran Compiler Reference*:
  - **-qinline**.
  - The *partition* parameter for **-qipa**.
  - **-qunroll**.
- On AIX, use the **rmss** command to mimic the memory conditions of your target system. This command can reduce effective real memory size and help you obtain more realistic profiles of your program and identify areas where code size could be a problem on smaller systems.

Be aware that optimization can cause code to expand significantly through loop unrolling, invariant **IF** floating, inlining, and other optimizations. The higher your optimization level, the more code size can increase. For more information on finding an optimization level appropriate for your application, see Chapter 1, “Optimizing your applications,” on page 1.

---

## Compiler option influences on code size

High optimization levels can increase code size. You can use other compiler options to influence the size of your code and improve performance.

### The **-qipa** compiler option

The **-qipa** option enables interprocedural analysis (IPA) by the compiler. Interprocedural analysis analyzes the relationships between procedures and the code that references those procedures, so that more optimizations within procedures and across procedure references can take place. Interprocedural analysis can decrease code size and improve performance at the same time. In some cases however, IPA inlining can increase code size. Use with discretion.

**Related reference:**



See interprocedural analysis (IPA) in the Compiler Reference

### The **-qinline** inlining option

Using the **-qinline** compiler option, you can specify that the compiler consider all procedures, or a particular list of procedures for inlining. Inlining procedures can increase the performance of your application. However, if your program references a procedure from many different locations in the source code, inlining that procedure can increase code size dramatically. You can use **-qnoinline** to disable procedure inlining entirely. You can also partially disable inlining with **-qinline-<procedure\_name>**.

Do not assume that all inlining increases code size. When your source code references a very small procedure many times, inlining can reduce code size, because inlining eliminates control transfer and data interface code. In addition, inlining code facilitates other optimizations at the point of inlining, by providing information on the values of arguments referencing the procedure. If a procedure is very small and is referenced from a number of places, inlining can also increase code locality and reduce code paging.

For details about the `-qinline` compiler option, see `-qinline` in the *XL Fortran Compiler Reference*.

## The `-qhot` compiler option

The loop analysis and optimization available when you specify `-qhot` can increase code size. If your application contains many large loops and loop optimization opportunities exist, `-qhot` can increase code size significantly along with performance. Specifying `-qhot=level=0` will perform minimal high-order transformations if code size is an issue. The topic High-order transformation contains more information on using `-qhot` effectively.

## The `-qcompact` compiler option

The `-qcompact` compiler option instructs the compiler to avoid certain optimizing transformations that expand the object code. Compiling with `-qcompact`, disables many transformations, including:

- Loop unrolling
- Expansion of fixed-point multiply by more than one instruction
- Inline expansion of some string and memory manipulation functions. In some cases `-qcompact` will avoid inlining opportunities entirely.

Specifying `-qcompact` creates a trade-off between the performance of individual routines in your application, and overall system performance. Suppressing transformations degrades the performance of individual routines, while overall system performance can increase as a more compact program can provide some or all of the following:

- Fewer instruction-cache misses
- Fewer TLB misses for pages of application code
- Fewer page faults for application code

---

## Other influences on code size

In addition to compiler options, there are a number of ways programming and analysis can influence the size of your source code.

## High activity areas

Once you apply the techniques discussed earlier in this section, your strategy for further code size reduction depends on your objective. Use profiling tools to locate hot spots in your program; then follow one of the following guidelines:

- If you want to reduce code size to reduce program paging, concentrate on minimizing branches and procedure references within those hot spots.
- If you want to reduce code size to reduce the size of your program's files on disk, concentrate on areas that are *not* hot spots. Remove any expansive optimizations from code that does not contain hot spots.

## Computed GOTOs and CASE constructs

A sparse computed **GOTO** can increase code size considerably. In a sparse computed **GOTO**, most statement labels point to the default. Consider the following example where label 10 is the default:

```
GOTO (10,10,10,10,20,10,10,10,10,30,20,10,10,10,10,  
+10,20,10,20,10,20,30,30,10,10,10,10,10,20,10,10,...  
+10,20,30,10,10,10,30,10,10,10,10,10,10,20,10,30) IA(I)  
  
GOTO 10  
30 CONTINUE  
! ...  
GOTO 10  
20 CONTINUE  
! ...  
10 CONTINUE
```

Although fewer cases are shown, the following **CASE** construct is functionally equivalent to the example above. N is the value of the largest integer that the computed **GOTO** or **CASE** construct is testing.

```
INTEGER IA(10000)  
SELECT CASE (IA(I))  
CASE DEFAULT  
GOTO 10  
CASE (5)  
GOTO 20  
CASE (10)  
GOTO 30  
CASE (11)  
GOTO 20  
! ...  
CASE (N-10)  
GOTO 30  
CASE (N-2)  
GOTO 20  
CASE (N)  
GOTO 30  
END SELECT
```

In both examples, the compiler builds a branch table in the object file that contains one entry for each possibility from 1 to N, where N is the largest integer value tested. The data section of the program stores this branch table. If N is very large, the table can increase both the size of the object file and the effects of data-cache misses.

If you use a **CASE** construct with a small number of cases and wide gaps between the test values of the cases, the compiler selects a different algorithm to dispatch to the appropriate location, and the resulting code can be more compact than a functionally equivalent computed **GOTO**. The compiler cannot determine that a computed **GOTO** has a default branch point, so the compiler assumes that any value in the range will be selected. In a **CASE** construct, the compiler assumes that cases you do not specify in the construct are handled as default.

## Code size with dynamic or static linking

Dynamic or static linking each affect the size of your code, and the resulting performance of your application.



## **Dynamic linking and code size**

When linking your programs, dynamic linking often ensures more compact code than linking statically. Dynamic linking does not include library procedures in your object file. Instead, a reference at run time causes the operating system to locate the dynamic library that contains the procedure, and reference that procedure from the library on the system. Only one copy of the procedure is in memory, even if several programs, or copies of a single program, are accessing the procedure simultaneously. This can reduce paging overhead. However, any libraries your program references must be present in your application's execution environment.

Note that if your program references high performance libraries like BLAS or ESSL, these procedures are dynamically linked to your program by default.

## **Static linking and code size**

Static linking binds library procedures into your application's object file. This can increase the size of your object file. If your program references only a small portion of the procedures available in a library, static linking can eliminate the need to provide the library to your users. However, static linking ties your application to one version of the library which can be detrimental in situations where your application will execute in different environments, such as different levels of the operating system.



---

## Chapter 5. Debugging optimized code

Debugging optimized programs presents special usability problems. Optimization can change the sequence of operations, add or remove code, change variable data locations, and perform other transformations that make it difficult to associate the generated code with the original source statements.

For example:

### Data location issues

With an optimized program, it is not always certain where the most current value for a variable is located. For example, a value in memory might not be current if the most current value is being stored in a register. Most debuggers cannot follow the removal of stores to a variable, and to the debugger it appears as though that variable is never updated, or possibly even never set. This contrasts with no optimization where all values are flushed back to memory and debugging can be more effective and usable.

### Instruction scheduling issues

With an optimized program, the compiler might reorder instructions. That is, instructions might not be executed in the order you would expect based on the sequence of lines in the original source code. Also, the sequence of instructions for a statement might not be contiguous. As you step through the program with a debugger, the program might appear as if it is returning to a previously executed line in the code (interleaving of instructions).

### Consolidating variable values

Optimizations can result in the removal and consolidation of variables. For example, if a program has two expressions that assign the same value to two different variables, the compiler might substitute a single variable. This can inhibit debug usability because a variable that a programmer is expecting to see is no longer available in the optimized program.

There are a couple of different approaches you can take to improve debug capabilities while also optimizing your program:

### Debug non-optimized code first

Debug a non-optimized version of your program first, and then recompile it with your desired optimization options. See “Debugging in the presence of optimization” on page 60 for some compiler options that are useful in this approach.

### Use `-g` level

Use the `-g` level suboption to control the amount of debugging information made available. Increasing it improves debug capability but prevents some optimizations. For more information, see `-g`.

### Use `-qoptdebug`

When compiling with `-O3` optimization level or higher, use the compiler option `-qoptdebug` to generate a pseudocode file that more accurately maps to how instructions and variable values will operate in an optimized program. With this option, when you load your program into a debugger,

you will be debugging the pseudocode for the optimized program. For more information, see “Using `-qoptdebug` to help debug optimized programs” on page 62.

---

## Understanding different results in optimized programs

Here are some reasons why an optimized program might produce different results from one that has not undergone the optimization process:

- Optimized code can fail if a program contains code that is not valid. For example, failure can occur if the program passes an actual argument that also appears in a common block in the called procedure, or if two or more dummy arguments are associated with the same actual argument. The optimization process relies on your application conforming to language standards.
- If a program that works without optimization fails when you optimize, check the cross-reference listing and the execution flow of the program for variables that are used before they are initialized. Compile with the `-qinitauto=hex_value` or `-qinitalloc=hex_value` option to try to produce the incorrect results consistently. For example, using `-qinitauto=FF` gives **REAL** and **COMPLEX** variables an initial value of "negative not a number" (-NAN). Any operations on these variables will also result in NAN values. Other bit patterns (*hex\_value*) might yield different results and provide further clues as to what is going on. Programs with uninitialized variables can appear to work properly when compiled without optimization because of the default assumptions the compiler makes, but such programs might fail when you optimize. Similarly, a program can appear to execute correctly after optimization, but it fails at lower optimization levels or when it is run in a different environment. You can also use the `-qcheck=unset` option and `-qinfo=unset` option to detect variables that are not or might not be initialized.
- Referring to an automatic-storage variable by its address after the owning function has gone out of scope leads to a reference to a memory location that can be overwritten as other auto variables come into scope as new functions are called.

Use with caution debugging techniques that rely on examining values in storage, unless the `-g8` or `-g9` option is in effect and the optimization level is `-O2`. The compiler might have deleted or moved a common expression evaluation. It might have assigned some variables to registers so that they do not appear in storage at all.

---

## Debugging in the presence of optimization

Debug and compile your program with your desired optimization options. Test the optimized program before placing it into production. If the optimized code does not produce the expected results, you can attempt to isolate the specific optimization problems in a debugging session.

The following list presents options that provide specialized information, which can be helpful during the debugging of optimized code:

**-qlist** Instructs the compiler to emit an object listing. The object listing includes hex and pseudo-assembly representations of the generated instructions, traceback tables, and text constants.

**-qreport** Instructs the compiler to produce a report of the loop transformations it performed, how the program was parallelized, what inlining was done,

and some other transformations. To generate a listing file, you must specify the **-qreport** option with at least one optimization option such as **-qhot**, **-qsmp**, **-qinline**, or **-qsimd**.

**-qinfo=HOSTASSOCIATION**

Issues an informational message for an entity that is accessed by host association for the first time. For details, see **-qinfo**.

**-qinfo=mt**

Reports potential synchronization issues in parallel code. For details, see **-qinfo**.

**-qinfo=unset**

Detects automatic variables that are used before they are set, and flags them with informational messages at compile time. For details, see **-qinfo**.

**-qipa=list**

Instructs the compiler to emit an object listing that provides information for IPA optimization.

**-qcheck**

Generates code that performs certain types of runtime checking.

**-qsmp=noopt**

If you are debugging SMP code, **-qsmp=noopt** ensures that the compiler performs only the minimum transformations necessary to parallelize your code and preserves maximum debug capability.

**-qkeepparm**

Ensures that procedure parameters are stored on the stack even during optimization. This can negatively impact execution performance. The **-qkeepparm** option then provides access to the values of incoming parameters to tools, such as debuggers, simply by preserving those values on the stack.

**-qinitialloc**

Instructs the compiler to emit code that initializes all allocatable and pointer variables that are allocated but not initialized to a given value.

**-qinitauto**

Instructs the compiler to emit code that initializes all automatic variables to a given value.

**-qextchk**

Generates additional symbolic information to allow the linker to do cross-file type checking of external variables and functions. This option requires the linker **-btypchk** option to be active.

**-g, -qdbg**

Generates debugging information to be used by a symbolic debugger. You can use different **-g** or **-qdbg** levels to debug optimized code by viewing or possibly modifying accessible variables at selected source locations in the debugger. Higher **-g** or **-qdbg** levels provide a more complete debug support, while lower levels provide higher runtime performance. For details, see **-g** or **-qdbg**.

In addition, you can also use the **SNAPSHOT** directive to ensure that certain variables are visible to the debugger at points in your application. For details, see **SNAPSHOT**.

---

## Using `-qoptdebug` to help debug optimized programs

The purpose of the `-qoptdebug` compiler option is to aid the debugging of optimized programs. It does this by creating pseudocode that maps more closely to the instructions and values of an optimized program than the original source code. When a program compiled with `-qoptdebug` is loaded into a debugger, you will be debugging the pseudocode rather than your original source. By making optimizations explicit in pseudocode, you can gain a better understanding of how your program is really behaving under optimization. Files containing the pseudocode for your program are generated with file suffix `.optdbg`. Only line debugging is supported for this feature.

**Note:** The compiler has introduced support for `-g` to provide support for various levels of trade-off between full debug support and optimization. If you want to debug your source code while taking advantage of compiler optimizations, use `-g` instead of `-qoptdebug`. For more information, see `-g`.

Compile your program as in the following example:

```
xlf myprogram.f -O3 -qhot -g -qoptdebug
```

In this example, your source file is compiled to `a.out`. The pseudocode for the optimized program is written to a file called `myprogram.optdbg`, which can be referred to when you debug your program.

### Notes:

- The `-g` or the `-qlinedebug` option must also be specified in order for the compiled executable to be debuggable. However, if neither of these options is specified, the pseudocode file `<output_file>.optdbg` that contains the optimized pseudocode is still generated.
- The `-qoptdebug` option takes effect only when one or more of the optimization options `-qhot`, `-qsmp`, `-qpdf`, or `-qipa` are specified, or when the optimization levels that imply these options are specified; that is, the optimization levels `-O3`, `-O4`, and `-O5`. The example shows the optimization options `-qhot` and `-O3`.

## Debugging the optimized program

From the following examples, you can see how the compiler might apply optimizations to a simple program and how debugging it can differ from debugging your original source.

Example 1: Represents the original non-optimized code for a simple program. It presents a couple of optimization opportunities to the compiler. For example, the variables `z` and `d` are both assigned by the equivalent expressions `x + y`. Therefore, these two variables can be consolidated in the optimized source. Also, the loop can be unrolled. In the optimized source, you can see iterations of the loop listed explicitly.

Example 2: Represents a listing of the optimized source as shown in the debugger. Note the unrolled loop and the consolidation of values assigned by the `x + y` expression.

Example 3: Shows an example of stepping through the optimized source using the debugger. Note that there is no longer a correspondence between the line numbers for these statements in the optimized source as compared with the line numbers in the original source.

### Example 1: Original code

```
FUNCTION FOO(X, Y)
  Z = X + Y
  D = X + Y
  DO I = 1, 4
    PRINT *, D, Z
  END DO
  FOO = X + Y
END FUNCTION

PROGRAM MAIN
CALL FOO(3.0, 4.0)
END PROGRAM MAIN
```

### Example 2: dbx debugger listing

```
(dbx) list
1
2
3      1|      REAL*4 FUNCTION foo (x, y)
4      1|      @CSE2 = x
5      |      @CSE1 = y
6      5|      #2 = _x1fBeginIO(6,257,#1,1024,NULL,0,NULL)
7      |      @CSE0 = @CSE2 + @CSE1
8      |      #3 = @CSE0
9      |      CALL _x1fWriteLDReal(%VAL(#2),#3,4,4)
10     |      #4 = @CSE0
11     |      CALL _x1fWriteLDReal(%VAL(#2),#4,4,4)
12     |      _x1fEndIO(%VAL(#2))
13     |      #2 = _x1fBeginIO(6,257,#1,1024,NULL,0,NULL)
14     |      #3 = @CSE0
15     |      CALL _x1fWriteLDReal(%VAL(#2),#3,4,4)
16     |      #4 = @CSE0
17     |      CALL _x1fWriteLDReal(%VAL(#2),#4,4,4)
18     |      _x1fEndIO(%VAL(#2))
19     |      #2 = _x1fBeginIO(6,257,#1,1024,NULL,0,NULL)
20     |      #3 = @CSE0
21     |      CALL _x1fWriteLDReal(%VAL(#2),#3,4,4)
22     |      #4 = @CSE0
23     |      CALL _x1fWriteLDReal(%VAL(#2),#4,4,4)
24     |      _x1fEndIO(%VAL(#2))
25     |      #2 = _x1fBeginIO(6,257,#1,1024,NULL,0,NULL)
26     |      #3 = @CSE0
27     |      CALL _x1fWriteLDReal(%VAL(#2),#3,4,4)
28     |      #4 = @CSE0
29     |      CALL _x1fWriteLDReal(%VAL(#2),#4,4,4)
30     |      _x1fEndIO(%VAL(#2))
31     8|      RETURN
32     |      END FUNCTION foo
33
34
35     10|      PROGRAM main ()
36     11|      T_3 = 3.00000000E+00
37     |      T_4 = 4.00000000E+00
38     |      CALL foo(T_3,T_4)
39     12|      CALL _x1fExit(0)
40     |      CALL _trap(3)
41     |      END PROGRAM main
```

### Example 3: Stepping through optimized source

```
(dbx) stop at 17
[1] stop at "myprogram.o.rptdbg":17
(dbx) cont
7.000000000 7.000000000
[1] stopped in foo at line 17 in file "myprogram.o.rptdbg"
17      CALL _x1fWriteLDReal(%VAL(#2),#4,4,4)
```

```
(dbx) step
7.000000000 7.000000000
stopped in foo at line 18 in file "myprogram.o.rptdbg"
18          _xlfEndIO(%VAL(#2))
(dbx) step
stopped in foo at line 20 in file "myprogram.o.rptdbg"
20          #3 = @CSE0
(dbx) step
stopped in foo at line 22 in file "myprogram.o.rptdbg"
22          #4 = @CSE0
(dbx) step
stopped in foo at line 23 in file "myprogram.o.rptdbg"
23          CALL _xlfWriteLDReal(%VAL(#2),#4,4,4)
(dbx) step
7.000000000 7.000000000
stopped in foo at line 24 in file "myprogram.o.rptdbg"
24          _xlfEndIO(%VAL(#2))
(dbx) step
stopped in foo at line 26 in file "myprogram.o.rptdbg"
26          #3 = @CSE0
(dbx) cont
7.000000000 7.000000000

execution completed
```



---

## Chapter 6. Compiler-friendly programming techniques

Writing compiler-friendly code, with both the optimizer and portability in mind, can be as important to the performance of your application as the compilation options that you specify.

---

### General practices

It is not necessary to hand-optimize your code, as hand-optimizing can introduce unusual constructs that can obscure the intentions of your application from the compiler and limit optimization opportunities.

Large programs might require 64-bit mode to address larger amounts of memory for data or code. However, use of 64-bit mode implies the use of 64-bit instructions and 64-bit data addresses, which can negatively affect performance due to increased memory usage. Use 64-bit mode only if your application requires the additional address space resources it provides you with.

Avoid breaking your program into too many small functions, as this can increase the percentage of time the program spends in dealing with call overhead. If you choose to use many small functions, compiling with **-qipa** can help minimize the impact on performance. Attempting to optimize an application with many small functions without the benefit of **-qipa** can severely limit the scope of other optimizations.

Use command invocations like **xlF90** and **xlF95**, which use **-qnosave**. The **-qnosave** option sets the default storage class of all variables to automatic. This provides more opportunities for optimization. When the **xlF** invocation command is used to compile the **.f**, **.F**, **.f77**, or **.F77** files, the default is **-qsave**. The **f77** and **fort77** invocation commands also use **-qsave** by default. All the other invocation commands use **-qnosave** by default.

Use modules to group related subroutines and functions.

Use module variables instead of common blocks for global storage.

Mark all code that accesses or manipulates data objects by independent I/O processes and independent, asynchronously interrupting processes as **VOLATILE**. For example, mark code that accesses shared variables and pointers to shared variables. Mark your code carefully however, as **VOLATILE** is a barrier to optimization as accessing a **VOLATILE** object forces the compiler to always load the value from storage. This prevents powerful optimizations such as constant propagation or invariant code motion.

The XL compilers support high performance libraries that can provide significant advantages over custom implementations or generic libraries.

---

### Variables and pointers

The effective use of aliasing and of variables and pointers provides opportunities for improved performance and further optimization.

Obey all aliasing rules. Avoid specifying **-qalias=nostd**. For more information on aliasing and how it can affect performance, see “Aliasing” on page 49.

Avoid unnecessary use of global variables and pointers, including module variables and common blocks. When using global variables and pointers in a loop, load them into a local variable before the loop and store them back after. If you do not use the local variable somewhere other than in the loop body, the optimization process can usually recognize what you are doing and expose more optimization opportunities. Replacing a global variable in a loop with a local variable reduces the possibilities for aliasing.

Use the **INTENT** statement to describe the usage of dummy arguments.

Limit the use of **ALLOCATABLE** objects and **POINTER** variables to situations demanding dynamic memory allocation.

---

## Arrays

Where possible, use local variables instead of global variables for loop index variables and bounds.

Whenever possible, ensure references to arrays or array sections refer to contiguous blocks of storage. Noncontiguous memory array references, when passed as parameters, lead to copy-in and copy-out operations.

**F2008** When declaring an array pointer or an assumed-shape array, you can use the **CONTIGUOUS** attribute to ensure that the array elements in order are stored in contiguous memory and not separated by other data objects. An array pointer with the **CONTIGUOUS** attribute can only be pointer associated with a contiguous target. An assumed-shape array with the **CONTIGUOUS** attribute is always contiguous; however, the corresponding actual argument can be contiguous or noncontiguous. If it is noncontiguous, the compiler makes it contiguous by creating a temporary contiguous argument. When the **CONTIGUOUS** attribute is used, the compiler can perform appropriate semantic check and detect invalid codes, which helps you write more optimized codes and enables the compiler to further optimize the runtime performance and storage layout. **F2008**

Keep your array expressions simple so that the optimizer can deduce access patterns more easily and reuse index calculations in whole or in part.

Frequent use of array-to-array assignment and **WHERE** constructs can impact performance by increasing temporary storage and creating loops. Using **-qlist** or **-qreport** can help you understand the performance characteristics of your code, and where applying **-qhot** could be beneficial. If you are already optimizing with **-qipa**, ensure you are using the **list=filename** option, so that the **-qlist** listing file is not overwritten.

### Related information

- **F2008** The **CONTIGUOUS** attribute **F2008**

---

## Choosing appropriate variable sizes

Improve the efficiency of your application by choosing the appropriate variable sizes.

When programming SMP applications, use the **CONTAINS** statement only to share thread local storage.

In most cases using **INTEGER(4)** in 32-bit mode and **INTEGER(8)** in 64-bit mode for scalars improves the efficiency of DO loops, subscripting, mathematical calculations and calling conventions when passing objects. However, if your code contains large arrays with values that can fit in an **INTEGER(1)** or **INTEGER(2)** in 32-bit mode, or an **INTEGER(4)** in 64-bit mode, using smaller kind parameters can actually improve memory efficiency by reducing memory traffic to load or store data.

Use the lowest floating-point precision appropriate to your application. Higher precisions can reduce performance, so use the **REAL(16)**, or **COMPLEX(16)** data types only when you require extremely high precision.

On systems with VMX, using **REAL(4)** and **-qsimd=auto** provides opportunities for short vectorization that is not available with larger floating-point types. On systems with VSX, **-qsimd=auto** provides opportunities for vectorization on the **REAL(8)** type.

---

## Submodules (Fortran 2008)

The submodule feature provides more structural facilities for modules.

When you compile a source file that contains submodules, a submodule symbol file named *ancestormodulename\_submodulename.smod* is generated for each submodule. These output .smod files are to be used as input when you compile the descendant submodules.

You can use a module to declare the interfaces of module procedures and the descendant submodules to implement those module procedures. If the implementation of the procedures is changed, but their interfaces remain the same, you are not required to recompile the file that contains the module. An .smod file of a submodule is the prerequisite of its descendant submodules only.

A submodule extends a module or another submodule and can have its descendant submodules. You can put entities at intermediate levels that are shared by the descendant submodules at lower levels. Changing these entities cannot change the interpretation of anything that is accessible from the module by use association. Users of modules that embody large complicated concepts can organize components of the concept into submodules. At the same time, they can prevent the privacy of entities that is shared by the submodules and that is not to be displayed to the module users. In addition, putting these shared entities at an intermediate level also prevents cascades of reprocessing and testing if some of them are changed.

Because submodules cannot be accessed by use association, two submodules of different modules can access the ancestor module of each other through use association without causing circular dependency.

### Example

The following example illustrates four modules with their descendant submodules and a main program.

- A module `m1`, which has a submodule `m1sub`.

- A module m2, which has a submodule m2sub, which in turn has a submodule m2sub2.
- Modules m3 and m4, which do not have descendant submodules.

The module m1, m2, and m4 are defined as follows. Both m2 and m4 use m1 in host associated scope.

```

MODULE m1
  TYPE Base
    INTEGER :: i
  END TYPE

  INTERFACE
    MODULE SUBROUTINE sub1(i, b) ! Module procedure interface body for sub1
      INTEGER, INTENT(IN) :: i
      TYPE(Base), INTENT(IN) :: b
    END SUBROUTINE
  END INTERFACE
END MODULE

MODULE m2
  USE m1 ! Use association of module m1

  INTERFACE
    REAL MODULE FUNCTION func1() ! Module procedure interface body for func1
    END FUNCTION

    MODULE FUNCTION func2(b) ! Module procedure interface body for func2
      TYPE(Base) :: b
      TYPE(Base) :: func2
    END FUNCTION
  END INTERFACE
END MODULE

MODULE m4
  USE m1 ! Use association of module m1
  TYPE, EXTENDS(Base) :: NewType
    REAL :: j
  END TYPE
END MODULE

```

The submodule m1sub, which extends module m1, and submodule m2sub, which extends module m2, are defined as follows. The use association of module m4 in m1sub does not cause circular reference.

```

SUBMODULE (m1) m1sub
  USE m4 ! Use association of module m4

  CONTAINS
    MODULE SUBROUTINE sub1(i, b) ! Implementation of sub1 declared in m1
      INTEGER, INTENT(IN) :: i
      TYPE(Base), INTENT(IN) :: b
      PRINT *, "sub1", i, b
    END SUBROUTINE
  END SUBMODULE

SUBMODULE (m2) m2sub

  CONTAINS
    REAL MODULE FUNCTION func1() ! Implementation of func1 declared in m2
      func1 = 20
    END FUNCTION
  END SUBMODULE

```

The third level submodule m2sub2, which extends its parent submodule m2sub, is defined as follows.

```

SUBMODULE (m2:m2sub) m2sub2

CONTAINS
  MODULE FUNCTION func2(b)      ! Implementation of func2 declared in m2
    TYPE(Base) :: b
    TYPE(Base) :: func2
    func2 = b
  END FUNCTION
END SUBMODULE

```

The module m3 is defined as follows. Type Base is still accessible by host association of m1 in m2.

```

MODULE m3
  INTERFACE
    SUBROUTINE interfaceSub1(i, b)
      USE m1
      INTEGER, INTENT(IN) :: i
      TYPE(Base), INTENT(IN) :: b
    END SUBROUTINE

    REAL FUNCTION interfaceFunc1()
    END FUNCTION

    FUNCTION interfaceFunc2(b)
      USE m1
      TYPE(Base) :: b
      TYPE(Base) :: interfaceFunc2
    END FUNCTION
  END INTERFACE

  TYPE Container
    PROCEDURE(interfaceSub1), NOPASS, POINTER :: pp1
    PROCEDURE(interfaceFunc1), NOPASS, POINTER :: pp2
    PROCEDURE(interfaceFunc2), NOPASS, POINTER :: pp3
  END TYPE
END MODULE

```

The program example, which uses m1, m2, and m3, is defined as follows.

```

PROGRAM example
  USE m1
  USE m2
  USE m3
  TYPE(Container) :: c1
  c1%pp1 => sub1
  c1%pp2 => func1
  c1%pp3 => func2

  CALL c1%pp1(10, Base(11))
  PRINT *, "func1", int(c1%pp2())
  PRINT *, "func2", c1%pp3(Base(5))
END PROGRAM

```

When you compile the source files that contain the submodules m1sub, m2sub, and m2sub2, the following submodule symbol files are generated:

```

m1_m1sub.smod
m2_m2sub.smod
m2_m2sub2.smod

```

## Related information

- Submodules
- The SUBMODULE statement
- XL Fortran input files

- XL Fortran output files

---

## Chapter 7. High performance libraries

XL Fortran is shipped with the following set of libraries for high-performance mathematical computing:

- **Mathematical Acceleration Subsystem (MASS).** It is a set of libraries of tuned mathematical intrinsic routines that provide improved performance over the corresponding standard system math library routines. MASS is described in “Using the Mathematical Acceleration Subsystem (MASS) libraries.”
- **Basic Linear Algebra Subprograms (BLAS).** They are a subset of routines from IBM's Engineering and Scientific Subroutine Library (ESSL) library, which provides matrix/vector multiplication functions tuned for PowerPC architectures. The BLAS functions are described in “Using the Basic Linear Algebra Subprograms – BLAS” on page 85.

Note that if you are going to link your application with the ESSL libraries, using `-qess1` and IPA allows the optimizer to automatically use ESSL routines.

---

### Using the Mathematical Acceleration Subsystem (MASS) libraries

XL Fortran is shipped with a set of Mathematical Acceleration Subsystem (MASS) libraries for high-performance mathematical computing.

The MASS libraries consist of a library of scalar Fortran routines described in “Using the scalar library” on page 72, a set of vector libraries tuned for specific architectures described in “Using the vector libraries” on page 74, and a set of SIMD libraries tuned for specific architectures described in “Using the SIMD libraries” on page 79. The functions contained in both scalar and vector libraries are automatically called at certain levels of optimization, but you can also call them explicitly in your programs. Note that accuracy and exception handling might not be identical in MASS functions and system library functions.

The MASS functions must run with the default rounding mode and floating-point exception trapping settings.

When you compile programs with any of the following sets of options:

- **`-qhot -qnostrict`**
- **`-qhot -O3 -qstrict=no library`**
- **`-qhot -O3`**
- **`-O4`**
- **`-O5`**

the compiler automatically attempts to vectorize calls to system math functions by calling the equivalent MASS vector functions (with the exceptions of functions `vatan2`, `vsatan2`, `vdnint`, `vdint`, `vcosisin`, `vscosisin`, `vqdrft`, `vsqdrft`, `vrqdrft`, `vsrqdrft`, `vpopcnt4`, `vpopcnt8`, `vexp2`, `vexp2m1`, `vsexp2`, `vsexp2m1`, `vlog2`, `vlog21p`, `vslog2`, and `vslog21p`). If it cannot vectorize, it automatically tries to call the equivalent MASS scalar functions. For automatic vectorization or scalarization, the compiler uses versions of the MASS functions contained in the XLOPT library `libxlopt.a`.

In addition to any of the preceding sets of options, when the **-qipa** option is in effect, if the compiler cannot vectorize, it tries to inline the MASS scalar functions before deciding to call them.

“Compiling and linking a program with MASS” on page 84 describes how to compile and link a program that uses the MASS libraries, and how to selectively use the MASS scalar library functions in conjunction with the regular system libraries.

#### Related external information

 Mathematical Acceleration Subsystem website, available at <http://www.ibm.com/software/awdtools/mass/>

## Using the scalar library

The MASS scalar library `libmass.a` contains an accelerated set of frequently used math intrinsic functions that provide improved performance over the corresponding standard system library functions. The MASS scalar functions are used when you explicitly link `libmass.a`.

If you want to explicitly call the MASS scalar functions, you can take the following steps:

1. Link the MASS scalar library `libmass.a` with your application. For instructions, see “Compiling and linking a program with MASS” on page 84
2. All the MASS scalar routines, except those listed in step 3 are recognized by XL Fortran as intrinsic functions, so no explicit interface block is needed. To provide an interface block for the functions listed in step 3, include `mass.include` in your source file.
3. Include `mass.include` in your source file for the following functions:
  - `acosf`, `acoshf`, `asinf`, `asinhf`, `atan2f`, `atanf`, `atanhf`, `cbrt`, `cbrtf`, `copysign`, `copysignf`, `cosf`, `coshf`, `cosisin`, `erff`, `erfcf`, `expf`, `expm1f`, `hypotf`, `lgammaf`, `logf`, `log10f`, `log1pf`, `rsqrt`, `sinf`, `sincos`, `sinhf`, `tanf`, `tanhf`, and `x**y`

The MASS scalar functions accept double-precision parameters and return a double-precision result, or accept single-precision parameters and return a single-precision result, except `sincos` which gives 2 double-precision results. They are summarized in Table 16.

Table 16. MASS scalar functions

Double-precision function	Single-precision function	Arguments	Description
<code>acos</code>	<code>acosf</code>	$(x)$	Returns the arccosine of $x$
<code>acosh</code>	<code>acoshf</code>	$(x)$	Returns the hyperbolic arccosine of $x$
	<code>anint</code>	$(x)$	Returns the rounded integer value of $x$
<code>asin</code>	<code>asinf</code>	$(x)$	Returns the arcsine of $x$
<code>asinh</code>	<code>asinhf</code>	$(x)$	Returns the hyperbolic arcsine of $x$
<code>atan2</code>	<code>atan2f</code>	$(x, y)$	Returns the arctangent of $x/y$
<code>atan</code>	<code>atanf</code>	$(x)$	Returns the arctangent of $x$
<code>atanh</code>	<code>atanhf</code>	$(x)$	Returns the hyperbolic arctangent of $x$
<code>cbrt</code>	<code>cbrtf</code>	$(x)$	Returns the cube root of $x$
<code>copysign</code>	<code>copysignf</code>	$(x, y)$	Returns $x$ with the sign of $y$



Table 16. MASS scalar functions (continued)

Double-precision function	Single-precision function	Arguments	Description
cos	cosf	(x)	Returns the cosine of x
cosh	coshf	(x)	Returns the hyperbolic cosine of x
cosisin		(x)	Returns a complex number with the real part the cosine of x and the imaginary part the sine of x.
dnint		(x)	Returns the nearest integer to x (as a double)
erf	erff	(x)	Returns the error function of x
erfc	erfcf	(x)	Returns the complementary error function of x
exp	expf	(x)	Returns the exponential function of x
expm1	expm1f	(x)	Returns (the exponential function of x) - 1
hypot	hypotf	(x,y)	Returns the square root of $x^2 + y^2$
lgamma	lgammaf	(x)	Returns the natural logarithm of the absolute value of the Gamma function of x
log	logf	(x)	Returns the natural logarithm of x
log10	log10f	(x)	Returns the base 10 logarithm of x
log1p	log1pf	(x)	Returns the natural logarithm of (x + 1)
rsqrt		(x)	Returns the reciprocal of the square root of x
sin	sinf	(x)	Returns the sine of x
sincos		(x,s,c)	Sets s to the sine of x and c to the cosine of x
sinh	sinhf	(x)	Returns the hyperbolic sine of x
sqrt		(x)	Returns the square root of x
tan	tanf	(x)	Returns the tangent of x
tanh	tanhf	(x)	Returns the hyperbolic tangent of x
x**y		(x,y)	Returns x raised to the power y

The MASS library interfaces include the following features:

- The scalar functions have generic interfaces so that the same name (the name used for the real\*8 function in previous versions) can be called with either real\*4 or real\*8 arguments.
- The scalar functions are marked pure. You can call them from pure procedures.
- The scalar functions are marked elemental. You can call them with an array argument and apply them to all the array elements.
- The intent of the argument is specified to assist in compiler error checking.

The following example shows the XL Fortran interface declaration of the acos and acosf scalar functions:

```
INTERFACE acos
  PURE ELEMENTAL REAL*8 FUNCTION acos (x)
    REAL*8, value :: x
```

```

END FUNCTION

PURE ELEMENTAL REAL*4 FUNCTION acosf (x)
  REAL*4, value :: x
END FUNCTION
END INTERFACE

```

The following example shows the XL Fortran interface declaration for the `rsqrt` scalar function:

```

INTERFACE
  ! Returns the reciprocal of the square root of x.
  REAL(8) FUNCTION rsqrt(x)
    REAL(8), value :: x
  END FUNCTION
END INTERFACE

```

Although most of the scalar MASS functions have separate implementations tuned for optimal performance with `real*4` and `real*8` arguments, the functions `cosisin`, `rsqrt`, and `sincos` have only `real*8` versions. These functions have only the `real*8` interface in `mass.include`, but they can be called with `real*4` or `real*8` arguments and will operate correctly.

#### Notes:

- The trigonometric functions (`sin`, `cos`, `tan`) return NaN (Not-a-Number) for large arguments (where the absolute value is greater than  $2^{50}\pi$ ).
- In some cases, the MASS functions are not as accurate as the ones in the `libm.a` library, and they might handle edge cases differently (`sqrt(Inf)`, for example).
- For accuracy comparisons with `libm.a`, see Product documentation (manuals) in the Product support content section of the Mathematical Acceleration Subsystem website.

#### Related external information

 Mathematical Acceleration Subsystem website, available at <http://www.ibm.com/software/awdtools/mass/>

## Using the vector libraries

If you want to explicitly call any of the MASS vector functions, you can do so by including `massv.include` in your source files and linking your application with the appropriate vector library. Information about linking is provided in “Compiling and linking a program with MASS” on page 84.

The vector libraries shipped with XL Fortran are listed below:

#### **libmassv.a**

The generic vector library that runs on any supported POWER<sup>®</sup> processor. Unless your application requires this portability, use the appropriate architecture-specific library below for maximum performance.

#### **libmassvp4.a**

Contains some functions that are tuned for the POWER4 architecture. The remaining functions are identical to those in `libmassv.a`. If you are using a PPC970 machine, this library is the recommended choice.

#### **libmassvp5.a**

Contains some functions that are tuned for the POWER5 architecture. The remaining functions are identical to those in `libmassv.a`.

### libmassvp6.a

Contains some functions that are tuned for the POWER6 architecture. The remaining functions are identical to those in libmassv.a.

### libmassvp7.a

Contains functions that are tuned for the POWER7 architecture.

### libmassvp8.a

Contains functions that are tuned for the POWER8 architecture.

All libraries can be used in either 32-bit or 64-bit mode.

The single-precision and double-precision floating-point functions contained in the vector libraries are summarized in Table 17. The integer functions contained in the vector libraries are summarized in Table 18 on page 77.

With the exception of a few functions (described in the following paragraph), all of the floating-point functions in the vector libraries accept three arguments:

- A double-precision (for double-precision functions) or single-precision (for single-precision functions) vector output argument.
- A double-precision (for double-precision functions) or single-precision (for single-precision functions) vector input argument.
- An integer vector-length argument.

The functions are of the form

*function\_name* (*y,x,n*)

where *y* is the target vector, *x* is the source vector, and *n* is the vector length. The arguments *y* and *x* are assumed to be double-precision for functions with the prefix *v*, and single-precision for functions with the prefix *vs*. As an example, the following code outputs a vector *y* of length 500 whose elements are  $\exp(x(i))$ , where  $i=1,\dots,500$ :

```
include 'massv.include'

real(8) x(500), y(500)
integer n
n = 500
...
call vexp (y, x, n)
```

The functions *vdiv*, *vsincos*, *vpow*, and *vatan2* (and their single-precision versions, *vsdiv*, *vssincos*, *vspow*, and *vsatan2*) take four arguments. The functions *vdiv*, *vpow*, and *vatan2* take the arguments (*z,x,y,n*). The function *vdiv* outputs a vector *z* whose elements are  $x(i)/y(i)$ , where  $i=1,\dots,n$ . The function *vpow* outputs a vector *z* whose elements are  $x(i)^{y(i)}$ , where  $i=1,\dots,n$ . The function *vatan2* outputs a vector *z* whose elements are  $\text{atan}(x(i)/y(i))$ , where  $i=1,\dots,n$ . The function *vsincos* takes the arguments (*y,z,x,n*), and outputs two vectors, *y* and *z*, whose elements are  $\sin(x(i))$  and  $\cos(x(i))$ , respectively.

In *vcosisin*(*y,x,n*) and *vscosisin*(*y,x,n*), *x* is a vector of *n* elements and the function outputs a vector *y* of *n* complex(8) (for *vcosisin*) or complex(4) (for *vscosisin*) elements of the form  $(\cos(x(i)),\sin(x(i)))$ .

Table 17. MASS floating-point vector library functions

Double-precision function	Single-precision function	Arguments	Description
vacos	vsacos	( <i>y,x,n</i> )	Sets <i>y</i> ( <i>i</i> ) to the arc cosine of <i>x</i> ( <i>i</i> ), for $i=1,\dots,n$

Table 17. MASS floating-point vector library functions (continued)

Double-precision function	Single-precision function	Arguments	Description
vacosh	vsacosh	(y, x, n)	Sets y(i) to the hyperbolic arc cosine of x(i), for i=1,...,n
vasin	vsasin	(y, x, n)	Sets y(i) to the arc sine of x(i), for i=1,...,n
vasinh	vsasinh	(y, x, n)	Sets y(i) to the arc hyperbolic sine of x(i), for i=1,...,n
vatan2	vsatan2	(z, x, y, n)	Sets z(i) to the arc tangent of x(i)/y(i), for i=1,...,n
vatanh	vsatanh	(y, x, n)	Sets y(i) to the arc hyperbolic tangent of x(i), for i=1,...,n
vcbrt	vsqrt	(y, x, n)	Sets y(i) to the cube root of x(i), for i=1,...,n
vcos	vscos	(y, x, n)	Sets y(i) to the cosine of x(i), for i=1,...,n
vcosh	vscosh	(y, x, n)	Sets y(i) to the hyperbolic cosine of x(i), for i=1,...,n
vcosisin	vscosisin	(y, x, n)	Sets the real part of y(i) to the cosine of x(i) and the imaginary part of y(i) to the sine of x(i), for i=1,...,n
vdint		(y, x, n)	Sets y(i) to the integer truncation of x(i), for i=1,...,n
vdiv	vdiv	(z, x, y, n)	Sets z(i) to x(i)/y(i), for i=1,...,n
vdnint		(y, x, n)	Sets y(i) to the nearest integer to x(i), for i=1,...,n
verf	vserf	(y, x, n)	Sets y(i) to the error function of x(i), for i=1,...,n
verfc	vserfc	(y, x, n)	Sets y(i) to the complimentary error function of x(i), for i=1,...,n
vexp	vsexp	(y, x, n)	Sets y(i) to the exponential function of x(i), for i=1,...,n
vexp2	vsexp2	(y, x, n)	Sets y(i) to 2 raised to the power of x(i), for i=1,...,n
vexpm1	vsexpm1	(y, x, n)	Sets y(i) to (the exponential function of x(i)) -1, for i=1,...,n
vexp2m1	vsexp2m1	(y, x, n)	Sets y(i) to (2 raised to the power of x(i)) -1, for i=1,...,n
vhypot	vshypot	(z, x, y, n)	Sets z(i) to the square root of the sum of the squares of x(i) and y(i), for i=1,...,n
vlog	vslog	(y, x, n)	Sets y(i) to the natural logarithm of x(i), for i=1,...,n
vlog2	vslog2	(y, x, n)	Sets y(i) to the base-2 logarithm of x(i), for i=1,...,n
vlog10	vslog10	(y, x, n)	Sets y(i) to the base-10 logarithm of x(i), for i=1,...,n
vlog1p	vslog1p	(y, x, n)	Sets y(i) to the natural logarithm of (x(i)+1), for i=1,...,n
vlog21p	vslog21p	(y, x, n)	Sets y(i) to the base-2 logarithm of (x(i)+1), for i=1,...,n
vpow	vspow	(z, x, y, n)	Sets z(i) to x(i) raised to the power y(i), for i=1,...,n
vqdrft	vsqdrft	(y, x, n)	Sets y(i) to the 4th root of x(i), for i=1,...,n
vrcbrt	vsrqrt	(y, x, n)	Sets y(i) to the reciprocal of the cube root of x(i), for i=1,...,n
vrec	vsrec	(y, x, n)	Sets y(i) to the reciprocal of x(i), for i=1,...,n
vrqdrft	vsrqdrft	(y, x, n)	Sets y(i) to the reciprocal of the 4th root of x(i), for i=1,...,n
vrsqrt	vsrsqrt	(y, x, n)	Sets y(i) to the reciprocal of the square root of x(i), for i=1,...,n
vsin	vssin	(y, x, n)	Sets y(i) to the sine of x(i), for i=1,...,n

Table 17. MASS floating-point vector library functions (continued)

Double-precision function	Single-precision function	Arguments	Description
vsincos	vssincos	(y,z,x,n)	Sets y(i) to the sine of x(i) and z(i) to the cosine of x(i), for i=1,...,n
vsinh	vssinh	(y,x,n)	Sets y(i) to the hyperbolic sine of x(i), for i=1,...,n
vsqrt	vssqrt	(y,x,n)	Sets y(i) to the square root of x(i), for i=1,...,n
vtan	vstan	(y,x,n)	Sets y(i) to the tangent of x(i), for i=1,...,n
vtanh	vstanh	(y,x,n)	Sets y(i) to the hyperbolic tangent of x(i), for i=1,...,n

Integer functions are of the form *function\_name* (x, n), where x is a vector of 4-byte (for vpopcnt4) or 8-byte (for vpopcnt8) numeric objects (integer or floating-point), and n is the vector length.

Table 18. MASS integer vector library functions

Function	Description	Interface
vpopcnt4	Returns the total number of 1 bits in the concatenation of the binary representation of x(i), for i=1,...,n, where x is vector of 32-bit objects	integer*4 function vpopcnt4 (x, n) integer*4 x(*), n
vpopcnt8	Returns the total number of 1 bits in the concatenation of the binary representation of x(i), for i=1,...,n, where x is vector of 64-bit objects	integer*4 function vpopcnt8 (x, n) integer*8 x(*) integer*4 n

The MASS vector library interfaces include the following features:

- The vector functions have generic interfaces so that the same name (the name used for the real\*8 function in previous versions) can be called with either real\*4 or real\*8 arguments.
- The vector functions are marked pure. You can call them from pure procedures.
- The intent of the argument is specified to assist in compiler error checking.

The following example shows the XL Fortran interface declaration of the vpopcnt generic vector function:

```

INTERFACE vpopcnt
  ! Returns the number of 1 bits in the concatenation of the binary
  ! representations of x(i) for i=1,...,n
  PURE INTEGER*4 FUNCTION vpopcnt8 (x, n)
    INTEGER*8, INTENT(IN) :: x(*)
    INTEGER*4, INTENT(IN) :: n
  END SUBROUTINE

  PURE INTEGER*4 FUNCTION vpopcnt4 (x, n)
    INTEGER*4, INTENT(IN) :: x(*)
    INTEGER*4, INTENT(IN) :: n
  END SUBROUTINE
END INTERFACE

```

The following example shows XL Fortran interface declarations for some of the MASS single-precision and double-precision functions:

```

INTERFACE vsqrt
  ! Sets y(i) to the square root of x(i), for i=1,...,n
  PURE SUBROUTINE vsqrt (y, x, n)
    REAL*8, INTENT(OUT) :: y(*)
    REAL*8, INTENT(IN) :: x(*)
    INTEGER*4, INTENT(IN) :: n
  END SUBROUTINE
END INTERFACE

```

```

END SUBROUTINE

PURE SUBROUTINE vssqrt (y, x, n)
  REAL*4, INTENT(OUT) :: y(*)
  REAL*4, INTENT(IN)  :: x(*)
  INTEGER*4, INTENT(IN) :: n
END SUBROUTINE
END INTERFACE

```

## Overlap of input and output vectors

In most applications, the MASS vector functions are called with disjoint input and output vectors; that is, the two vectors do not overlap in memory. Another common usage scenario is to call them with the same vector for both input and output parameters (for example, `vsin (y, y, n)`). For other kinds of overlap, be sure to observe the following restrictions, to ensure correct operation of your application:

- For calls to vector functions that take one input and one output vector (for example, `vsin (y, x, n)`):  
The vectors `x(1:n)` and `y(1:n)` must be either disjoint or identical, or the address of `x(1)` must be greater than the address of `y(1)`. That is, if `x` and `y` are not the same vector, the address of `y(1)` must not fall within the range of addresses spanned by `x(1:n)`, or unexpected results might be obtained.
- For calls to vector functions that take two input vectors (for example, `vatan2 (y, x1, x2, n)`):  
The previous restriction applies to both pairs of vectors `y,x1` and `y,x2`. That is, if `y` is not the same vector as `x1`, the address of `y(1)` must not fall within the range of addresses spanned by `x1(1:n)`; if `y` is not the same vector as `x2`, the address of `y(1)` must not fall within the range of addresses spanned by `x2(1:n)`.
- For calls to vector functions that take two output vectors (for example, `vsincos (x, y1, y2, n)`):  
The above restriction applies to both pairs of vectors `y1,x` and `y2,x`. That is, if `y1` and `x` are not the same vector, the address of `y1(1)` must not fall within the range of addresses spanned by `x(1:n)`; if `y2` and `x` are not the same vector, the address of `y2(1)` must not fall within the range of addresses spanned by `x(1:n)`. Also, the vectors `y1(1:n)` and `y2(1:n)` must be disjoint.

## Alignment of input and output vectors

To get the best performance from the POWER7 and POWER8 vector libraries, align the input and output vectors on 8-byte (or better, 16-byte) boundaries.

## Consistency of MASS vector functions

The accuracy of the vector functions is comparable to that of the corresponding scalar functions in `libmass.a`, though results might not be bitwise-identical.

In the interest of speed, the MASS libraries make certain trade-offs. One of these involves the consistency of certain MASS vector functions. For certain functions, it is possible that the result computed for a particular input value varies slightly (usually only in the least significant bit) depending on its position in the vector, the vector length, and nearby elements of the input vector. Also, the results produced by the different MASS libraries are not necessarily bit-wise identical.

All the functions in `libmassvp7.a` and `libmassvp8.a` are consistent.

The following functions are consistent in all versions of the library in which they appear.

#### double-precision functions

`vacos`, `vacosh`, `vasin`, `vasinh`, `vatan2`, `vatanh`, `vcbrt`, `vcos`, `vcosh`, `vcosisin`,  
`vdint`, `vdnint`, `vexp2`, `vexpm1`, `vexp2m1`, `vlog`, `vlog2`, `vlog10`, `vlog1p`, `vlog21p`,  
`vpow`, `vqdrct`, `vrcbrt`, `vrqdrct`, `vsin`, `vsincos`, `vsinh`, `vtan`, `vtanh`

#### single-precision functions

`vsacos`, `vsacosh`, `vsasin`, `vsasinh`, `vsatan2`, `vsatanh`, `vsqrt`, `vscos`, `vscosh`,  
`vscosisin`, `vsexp`, `vsexp2`, `vsexpm1`, `vsexp2m1`, `vslog`, `vslog2`, `vslog10`,  
`vslog1p`, `vslog21p`, `vspow`, `vsqdrct`, `vsrbrt`, `vsrqdrct`, `vssin`, `vssincos`,  
`vssinh`, `vssqrt`, `vstan`, `vstanh`

The following functions are consistent in `libmassvp3.a`, `libmassvp4.a`,  
`libmassvp5.a`, and `libmassvp6.a`:

`vsqrt` and `vrsqrt`.

The following functions are consistent in `libmassvp4.a`, `libmassvp5.a`, and  
`libmassvp6.a`:

`vrec`, `vsrec`, `vdiv`, `vsdiv`, and `vexp`.

The following function is consistent in `libmassv.a`, `libmassvp5.a`, and  
`libmassvp6.a`:

`vsrsqrt`.

Older, inconsistent versions of some of these functions are available on the *Mathematical Acceleration Subsystem for AIX website*. If consistency is not required, there might be a performance advantage to using the older versions. For more information on consistency and avoiding inconsistency with the vector libraries, as well as performance and accuracy data, see the *Mathematical Acceleration Subsystem website*.

#### Related external information

 [Mathematical Acceleration Subsystem for AIX website](http://www.ibm.com/software/awdtools/mass/aix), available at  
<http://www.ibm.com/software/awdtools/mass/aix>

 [Mathematical Acceleration Subsystem website](http://www.ibm.com/software/awdtools/mass/), available at  
<http://www.ibm.com/software/awdtools/mass/>

## Using the SIMD libraries

The MASS SIMD library `libmass_simdp7.a` or `libmass_simdp8.a` contains a set of frequently used math intrinsic functions that provide improved performance over the corresponding standard system library functions. If you want to use the MASS SIMD functions, you can do so as follows:

1. Provide the interfaces for the functions by including `mass_simd.include` in your source files.
2. Link the MASS SIMD library `libmass_simdp7.a` or `libmass_simdp8.a` with your application. For instructions, see “Compiling and linking a program with MASS” on page 84.

The single-precision MASS SIMD functions accept single-precision arguments and return single-precision results. Likewise, the double-precision MASS SIMD

functions accept double-precision arguments and return double-precision results. They are summarized in Table 19.

Table 19. MASS SIMD functions

Double-precision function	Single-precision function	Description	Double-precision function interface	Single-precision function interface
acosd2	acosf4	Computes the arc cosine of each element of vx.	vector(real(8)) function acosd2(vx) vector(real(8)), value :: vx	vector(real(4)) function acosf4(vx) vector(real(4)), value :: vx
acoshd2	acoshf4	Computes the arc hyperbolic cosine of each element of vx.	vector(real(8)) function acoshd2(vx) vector(real(8)), value :: vx	vector(real(4)) function acoshf4(vx) vector(real(4)), value :: vx
asind2	asinf4	Computes the arc sine of each element of vx.	vector(real(8)) function asind2(vx) vector(real(8)), value :: vx	vector(real(4)) function asinf4(vx) vector(real(4)), value :: vx
asinhd2	asinhf4	Computes the arc hyperbolic sine of each element of vx.	vector(real(8)) function asinhd2(vx) vector(real(8)), value :: vx	vector(real(4)) function asinhf4(vx) vector(real(4)), value :: vx
atand2	atanf4	Computes the arc tangent of each element of vx.	vector(real(8)) function atand2(vx) vector(real(8)), value :: vx	vector(real(4)) function atanf4(vx) vector(real(4)), value :: vx
atan2d2	atan2f4	Computes the arc tangent of each element of vx/vy.	vector(real(8)) function atan2d2(vx,vy) vector(real(8)), value :: vx, vy	vector(real(4)) function atan2f4(vx,vy) vector(real(4)), value :: vx, vy
atanhd2	atanhf4	Computes the arc hyperbolic tangent of each element of vx.	vector(real(8)) function atanhd2(vx) vector(real(8)), value :: vx	vector(real(4)) function atanhf4(vx) vector(real(4)), value :: vx
cbrtd2	cbrtf4	Computes the cube root of each element of vx	vector(real(8)) function cbrtd2(vx) vector(real(8)), value :: vx	vector(real(4)) function cbrtf4(vx) vector(real(4)), value :: vx
cosd2	cosf4	Computes the cosine of each element of vx.	vector(real(8)) function cosd2(vx) vector(real(8)), value :: vx	vector(real(4)) function cosf4(vx) vector(real(4)), value :: vx
coshd2	coshf4	Computes the hyperbolic cosine of each element of vx.	vector(real(8)) function coshd2(vx) vector(real(8)), value :: vx	vector(real(4)) function coshf4(vx) vector(real(4)), value :: vx



Table 19. MASS SIMD functions (continued)

Double-precision function	Single-precision function	Description	Double-precision function interface	Single-precision function interface
cosisind2	cosisinf4	<p>Computes the cosine and sine of each element of <math>x</math>, and stores the results in <math>y</math> and <math>z</math> as follows:</p> <p><code>cosisind2 (x, y, z)</code> sets the elements of <math>y</math> to <math>\cos(x_1)</math>, <math>\sin(x_1)</math>, and the elements of <math>z</math> to <math>\cos(x_2)</math>, <math>\sin(x_2)</math>, where <math>x_1, x_2</math> are the elements of <math>x</math>.</p> <p><code>cosisinf4 (x,y,z)</code> sets the elements of <math>y</math> to <math>\cos(x_1)</math>, <math>\sin(x_1)</math>, <math>\cos(x_2)</math>, <math>\sin(x_2)</math>, and the elements of <math>z</math> to <math>\cos(x_3)</math>, <math>\sin(x_3)</math>, <math>\cos(x_4)</math>, <math>\sin(x_4)</math>, where <math>x_1, x_2, x_3, x_4</math> are the elements of <math>x</math>.</p>	<p>subroutine <code>cosisind2 (x, y, z)</code>  <code>vector(real(8)), value :: x</code>  <code>vector(real(8)) y, z</code></p>	<p>subroutine <code>cosisinf4 (x, y, z)</code>  <code>vector(real(4)), value :: x</code>  <code>vector(real(4)) y, z</code></p>
divd2	divf4	Computes the quotient $v_x/v_y$ .	<p><code>vector(real(8)) function divd2(vx, vy)</code>  <code>vector(real(8)), value :: vx, vy</code></p>	<p><code>vector(real(4)) function divf4(vx, vy)</code>  <code>vector(real(4)), value :: vx, vy</code></p>
erfcd2	erfcf4	Computes the complementary error function of each element of $v_x$ .	<p><code>vector(real(8)) function erfcd2(vx)</code>  <code>vector(real(8)), value :: vx</code></p>	<p><code>vector(real(4)) function erfcf4(vx)</code>  <code>vector(real(4)), value :: vx</code></p>
erfd2	erff4	Computes the error function of each element of $v_x$ .	<p><code>vector(real(8)) function erfd2(vx)</code>  <code>vector(real(8)), value :: vx</code></p>	<p><code>vector(real(4)) function erff4(vx)</code>  <code>vector(real(4)), value :: vx</code></p>
expd2	expf4	Computes the exponential function of each element of $v_x$ .	<p><code>vector(real(8)) function expd2(vx)</code>  <code>vector(real(8)), value :: vx</code></p>	<p><code>vector(real(4)) function expf4(vx)</code>  <code>vector(real(4)), value :: vx</code></p>

Table 19. MASS SIMD functions (continued)

Double-precision function	Single-precision function	Description	Double-precision function interface	Single-precision function interface
exp2d2	exp2f4	Computes 2 raised to the power of each element of vx.	vector(real(8)) function exp2d2(vx) vector(real(8)), value :: vx	vector(real(4)) function exp2f4(vx) vector(real(4)), value :: vx
expm1d2	expm1f4	Computes (the exponential function of each element of vx) - 1.	vector(real(8)) function expm1d2(vx) vector(real(8)), value :: vx	vector(real(4)) function exp2m1f4(vx) vector(real(4)), value :: vx
exp2m1d2	exp2m1f4	Computes (2 raised to the power of each element of vx) - 1.	vector(real(8)) function exp2m1d2(vx) vector(real(8)), value :: vx	vector(real(4)) function exp2m1f4(vx) vector(real(4)), value :: vx
hypotd2	hypotf4	For each element of vx and the corresponding element of vy, computes $\sqrt{vx*vx + vy*vy}$ .	vector(real(8)) function hypotd2(vx,vy) vector(real(8)), value :: vx, vy	vector(real(4)) function hypotf4(vx,vy) vector(real(4)), value :: vx, vy
lgammad2	lgammaf4	Computes the natural logarithm of the absolute value of the Gamma function of each element of vx .	vector(real(8)) function lgammad2(vx) vector(real(8)), value :: vx	vector(real(4)) function lgammaf4(vx) vector(real(4)), value :: vx
logd2	logf4	Computes the natural logarithm of each element of vx.	vector(real(8)) function logd2(vx) vector(real(8)), value :: vx	vector(real(4)) function logf4(vx) vector(real(4)), value :: vx
log2d2	log2f4	Computes the base-2 logarithm of each element of vx.	vector(real(8)) function log2d2(vx) vector(real(8)), value :: vx	vector(real(4)) function log2f4(vx) vector(real(4)), value :: vx
log10d2	log10f4	Computes the base-10 logarithm of each element of vx.	vector(real(8)) function log10d2(vx) vector(real(8)), value :: vx	vector(real(4)) function log10f4(vx) vector(real(4)), value :: vx
log1pd2	log1pf4	Computes the natural logarithm of each element of (vx +1).	vector(real(8)) function log1pd2(vx) vector(real(8)), value :: vx	vector(real(4)) function log1pf4(vx) vector(real(4)), value :: vx

Table 19. MASS SIMD functions (continued)

Double-precision function	Single-precision function	Description	Double-precision function interface	Single-precision function interface
log21pd2	log21pf4	Computes the base-2 logarithm of each element of (vx +1).	vector(real(8)) function log21pd2(vx) vector(real(8)), value :: vx	vector(real(4)) function log21pf4(vx) vector(real(4)), value :: vx
powd2	powf4	Computes each element of vx raised to the power of the corresponding element of vy.	vector(real(8)) function powd2(vx, vy) vector(real(8)), value :: vx, vy	vector(real(4)) function powf4(vx, vy) vector(real(4)), value :: vx, vy
qdrtd2	qdrtf4	Computes the quad root of each element of vx.	vector(real(8)) function qdrtd2(vx) vector(real(8)), value :: vx	vector(real(4)) function qdrtf4(vx) vector(real(4)), value :: vx
rcbrtd2	rcbrtf4	Computes the reciprocal of the cube root of each element of vx.	vector(real(8)) function rcbrtd2(vx) vector(real(8)), value :: vx	vector(real(4)) function rcbrtf4(vx) vector(real(4)), value :: vx
recipd2	recipf4	Computes the reciprocal of each element of vx.	vector(real(8)) function recipd2(vx) vector(real(8)), value :: vx	vector(real(4)) function recipf4(vx) vector(real(4)), value :: vx
rqdrtd2	rqdrtf4	Computes the reciprocal of the quad root of each element of vx.	vector(real(8)) function rqdrtd2(vx) vector(real(8)), value :: vx	vector(real(4)) function rqdrtf4(vx) vector(real(4)), value :: vx
rsqrtd2	rsqrtf4	Computes the reciprocal of the square root of each element of vx.	vector(real(8)) function rsqrtd2(vx) vector(real(8)), value :: vx	vector(real(4)) function rsqrtf4(vx) vector(real(4)), value :: vx
sincosd2	sincosf4	Computes the sine and cosine of each element of vx.	subroutine sincosd2(vx, vs, vc) vector(real(8)), value :: vx vector(real(8)) vs, vc	subroutine sincosf4(vx, vs, vc) vector(real(4)), value :: vx vector(real(4)) vs, vc
sind2	sinf4	Computes the sine of each element of vx.	vector(real(8)) function sind2(vx) vector(real(8)), value :: vx	vector(real(4)) function sinf4(vx) vector(real(4)), value :: vx
sinhd2	sinhf4	Computes the hyperbolic sine of each element of vx.i	vector(real(8)) function sinhd2(vx) vector(real(8)), value :: vx	vector(real(4)) function sinhf4(vx) vector(real(4)), value :: vx
sqrtd2	sqrtf4	Computes the square root of each element of vx.	vector(real(8)) function sqrtd2(vx) vector(real(8)), value :: vx	vector(real(4)) function sqrtf4(vx) vector(real(4)), value :: vx

Table 19. MASS SIMD functions (continued)

Double-precision function	Single-precision function	Description	Double-precision function interface	Single-precision function interface
tand2	tanf4	Computes the tangent of each element of vx.	vector(real(8)) function tand2(vx) vector(real(8)), value :: vx	vector(real(4)) function tanf4(vx) vector(real(4)), value :: vx
tanh2	tanhf4	Computes the hyperbolic tangent of each element of vx.	vector(real(8)) function tanhd2(vx) vector(real(8)), value :: vx	vector(real(4)) function tanhf4(vx) vector(real(4)), value :: vx

The MASS SIMD library interfaces include the following features:

- The SIMD functions are marked pure. You can call them from pure procedures.
- The intent of the argument is specified to assist in compiler error checking.

The following example shows the XL Fortran interface declarations of some of MASS SIMD library functions:

```

INTERFACE
  PURE VECTOR(REAL*4) FUNCTION acosf4 (x)
    VECTOR(REAL*4), value :: x
  END FUNCTION

  PURE VECTOR(REAL*4) FUNCTION atan2f4 (x,y)
    VECTOR(REAL*4), value :: x,y
  END FUNCTION

  PURE SUBROUTINE sincosf4 (x,s,c)
    VECTOR(REAL*4), value :: x
    VECTOR(REAL*4), INTENT(OUT) :: s,c
  END SUBROUTINE
END INTERFACE

```

## Compiling and linking a program with MASS

To compile an application that calls the functions in the scalar, SIMD, or vector MASS libraries, specify **mass**, and/or one of **mass\_simdp7**, **mass\_simdp8**, and/or one of **massv**, **massvp4**, **massvp5**, **massvp6**, **massvp7**, **massvp8** on the **-l** linker option.

For example, if the MASS libraries are installed in the default directory, you can use one of the following commands:

**Link object file progf with scalar library libmass.a and vector library libmassvp8.a**

```
xlf -qarch=pwr8 progf.f -o progf -lmass -lmassvp8
```

**Link object file progf with SIMD library libmass\_simdp8.a**

```
xlf -qarch=pwr8 progf.f -o progf -lmass_simdp8
```

### Using libmass.a with the math system library

If you want to use the libmass.a scalar library for some functions and the normal math library libm.a for other functions, follow this procedure to compile and link your program:

1. Create an export list that is a flat text file and contains the names of the wanted functions. For example, to select only the fast tangent function from libmass.a for use with the Fortran program sample.f, create a file called fasttan.exp with the following line:

- ```
tan
```
2. Create a shared object from the export list with the **ld** command, linking with the `libmass.a` library. For example:

```
ld -bexport:fasttan.exp -o fasttan.o -bnoentry -lmass -bmodtype:SRE
```
  3. Archive the shared object into a library with the **ar** command. For example:

```
ar -q libfasttan.a fasttan.o
```
  4. Create the final executable using XL Fortran, specifying the object file containing the MASS functions *before* the standard math library, `libm.a`. This links only the functions specified in the object file (in this example, the `tan` function) and the remainder of the math functions from the standard math library. For example:

```
xlf sample.f -o sample -Ldir_containing_libfasttan -lfasttan -lm
```

**Notes:**

- The MASS `sincos` function is automatically linked if you export MASS `cosisin`.
- The MASS `cos` function is automatically linked if you export MASS `sin`.
- The MASS `atan2` is automatically linked if you export MASS `atan`.

**Related external information**

- **ar** and **ld** in the *AIX Commands Reference, Volumes 1 - 6*

## Using the Basic Linear Algebra Subprograms – BLAS

Four Basic Linear Algebra Subprograms (BLAS) functions are shipped with XL Fortran in the `libxlopt` library.

The functions consist of the following:

- `SGEMV` (single-precision) and `DGEMV` (double-precision), which compute the matrix-vector product for a general matrix or its transpose
- `SGEMM` (single-precision) and `DGEMM` (double-precision), which perform combined matrix multiplication and addition for general matrices or their transposes

**Note:** Some error-handling code has been removed from the BLAS functions in `libxlopt`, and no error messages are emitted for calls to the these functions.

“BLAS function syntax” describes the interfaces for the XL Fortran BLAS functions, which are similar to those of the equivalent BLAS functions shipped in IBM’s Engineering and Scientific Subroutine Library (ESSL); for more detailed information and examples of usage of these functions, you may want to consult the *Engineering and Scientific Subroutine Library Guide and Reference*, available at the Engineering and Scientific Subroutine Library (ESSL) and Parallel ESSL web page.

“Linking the `libxlopt` library” on page 88 describes how to link to the XL Fortran `libxlopt` library if you are also using a third-party BLAS library.

### BLAS function syntax

The interfaces for the `SGEMV` and `DGEMV` functions are as follows:

```
CALL SGEMV(trans, m, n, alpha, a, lda, x, incx, beta, y, incy)
CALL DGEMV(trans, m, n, alpha, a, lda, x, incx, beta, y, incy)
```

The parameters are as follows:

*trans*

is a single character indicating the form of the input matrix *a*, where:

- 'N' or 'n' indicates that *a* is to be used in the computation
- 'T' or 't' indicates that the transpose of *a* is to be used in the computation

*m* represents:

- the number of rows in input matrix *a*
- the length of vector *y*, if 'N' or 'n' is used for the *trans* parameter
- the length of vector *x*, if 'T' or 't' is used for the *trans* parameter

The number of rows must be greater than or equal to zero, and less than or equal to the leading dimension of the matrix *a* (specified in *lda*)

*n* represents:

- the number of columns in input matrix *a*
- the length of vector *x*, if 'N' or 'n' is used for the *trans* parameter
- the length of vector *y*, if 'T' or 't' is used for the *trans* parameter

The number of columns must be greater than or equal to zero.

*alpha*

is the scaling constant  $\alpha$

*a* is the input matrix of single-precision (for SGEMV) or double-precision (for DGEMV) real values

*lda*

is the leading dimension of the array specified by *a*. The number of rows must be greater than or equal to zero, and less than the leading dimension of the matrix *a* (specified in *lda*).

*x* is the input vector of single-precision (for SGEMV) or double-precision (for DGEMV) real values.

*incx*

is the stride for vector *x*. It can have any value.

*beta*

is the scaling constant  $\beta$

*y* is the output vector of single-precision (for SGEMV) or double-precision (for DGEMV) real values.

*incy*

is the stride for vector *y*. It must not be zero.

**Note:** Vector *y* must have no common elements with matrix *a* or vector *x*; otherwise, the results are unpredictable.

The prototypes for the SGEMM and DGEMM functions are as follows:

```
CALL SGEMM(transa, transb, l, n, m, alpha, a, lda, b, ldb, beta, c, ldc)
```

```
CALL DGEMM(transa, transb, l, n, m, alpha, a, lda, b, ldb, beta, c, ldc)
```

The parameters are as follows:

*transa*

is a single character indicating the form of the input matrix *a*, where:

- 'N' or 'n' indicates that *a* is to be used in the computation
- 'T' or 't' indicates that the transpose of *a* is to be used in the computation

*transb*

is a single character indicating the form of the input matrix  $b$ , where:

- 'N' or 'n' indicates that  $b$  is to be used in the computation
- 'T' or 't' indicates that the transpose of  $b$  is to be used in the computation

$l$  represents the number of rows in output matrix  $c$ . The number of rows must be less than or equal to the leading dimension of  $c$ .

$n$  represents the number of columns in output matrix  $c$ . The number of columns must be greater than or equal to zero.

$m$  represents:

- the number of columns in matrix  $a$ , if 'N' or 'n' is used for the *transa* parameter
- the number of rows in matrix  $a$ , if 'T' or 't' is used for the *transa* parameter

and:

- the number of rows in matrix  $b$ , if 'N' or 'n' is used for the *transb* parameter
- the number of columns in matrix  $b$ , if 'T' or 't' is used for the *transb* parameter

$m$  must be greater than or equal to zero.

*alpha*

is the scaling constant  $\alpha$

$a$  is the input matrix  $a$  of single-precision (for SGEMM) or double-precision (for DGEMM) real values

*lda*

is the leading dimension of the array specified by  $a$ . The leading dimension must be greater than zero. If *transa* is specified as 'N' or 'n', the leading dimension must be greater than or equal to 1. If *transa* is specified as 'T' or 't', the leading dimension must be greater than or equal to the value specified in  $m$ .

$b$  is the input matrix  $b$  of single-precision (for SGEMM) or double-precision (for DGEMM) real values.

*ldb*

is the leading dimension of the array specified by  $b$ . The leading dimension must be greater than zero. If *transb* is specified as 'N' or 'n', the leading dimension must be greater than or equal to the value specified in  $m$ . If *transa* is specified as 'T' or 't', the leading dimension must be greater than or equal to the value specified in  $n$ .

*beta*

is the scaling constant  $\beta$

$c$  is the output matrix  $c$  of single-precision (for SGEMM) or double-precision (for DGEMM) real values.

*ldc*

is the leading dimension of the array specified by  $c$ . The leading dimension must be greater than zero. If *transb* is specified as 'N' or 'n', the leading dimension must be greater than or equal to the value specified in  $l$ .

**Note:** Matrix  $c$  must have no common elements with matrices  $a$  or  $b$ ; otherwise, the results are unpredictable.

## Linking the libxlopt library

By default, the `libxlopt` library is linked with any application you compile with XL Fortran. However, if you are using a third-party BLAS library, but want to use the BLAS routines shipped with `libxlopt`, you must specify the `libxlopt` library before any other BLAS library on the command line at link time. For example, if your other BLAS library is called `libblas`, you would compile your code with the following command:

```
xlf app.f -lxlopt -lblas
```

The compiler will call the `SGEMV`, `DGEMV`, `SGEMM`, and `DGEMM` functions from the `libxlopt` library, and all other BLAS functions in the `libblas` library.



---

## Chapter 8. Parallel programming with XL Fortran

Parallel programming with XL Fortran involves a combination of compiling, setting of runtime options, and optimization of your code, by incorporating SMP directives and by using the pthreads library module.

XL Fortran supports the OpenMP specification, as understood and interpreted by IBM as well as the POSIX 1003.1-1996 standard, and the Draft 7 POSIX pthreads API on AIX.

**Note:** IBM implementation of OpenMP in XL Fortran is an extension to the standard Fortran language.

---

### Compiling your parallelized code

To compile parallelized code, you must specify the **-qsmp** compiler option. When compiling with **-qsmp**, the driver links the libraries found on the **smplibraries** line in the active stanza of your configuration file.

If you specify **-qsmp**, you must use an appropriate invocation command. Use any of the following invocations to compile SMP code or to ensure that the compiler links threadsafe libraries:

- **xlf\_r**
- **xlf\_r7**
- **xlf90\_r**
- **xlf90\_r7**
- **xlf95\_r**
- **xlf95\_r7**
- **xlf2003\_r**
- **xlf2008\_r**

For information on linking your 32- and 64-bit SMP code, see Linking 32-bit and Linking 64-bit SMP object files in the *XL Fortran Compiler Reference*.

**Related reference:**



See **-qsmp** in the Compiler Reference

### The **\_OPENMP C** preprocessor macro and conditional compilation

You can use sentinels to mark specific lines of an XL Fortran program for conditional compilation. This allows you to port code that contains statements that are only valid or applicable in an SMP environment to a non-SMP environment. You can do this using conditional compilation lines, or the **\_OPENMP C** preprocessor macro. This macro is defined when the C preprocessor is invoked and you specify the **-qsmp=omp** compiler option. See Passing Fortran files through the C preprocessor in the *Editing, Compiling, Linking, and Running XL Fortran Programs* section of the *XL Fortran Compiler Reference* for an example of using this macro.

The following example uses conditional compilation lines to hide OpenMP runtime routines. You cannot easily compile code that calls OpenMP runtime routines in a non-OpenMP environment without using conditional compilation. Since calls to the runtime routines are not directives, they cannot be hidden by the **!\$OMP** trigger. If

you do not compile the example with `-qsmp=omp`, the variable that stores the number of threads is assigned the value of 8.

### Example of conditional compilation lines

```

PROGRAM PAR_MAT_MUL
!$ USE OMP_LIB
IMPLICIT NONE
INTEGER(KIND=8)                :: I,J,NTHREADS
INTEGER(KIND=8),PARAMETER      :: N=60
INTEGER(KIND=8),DIMENSION(N,N) :: AI,BI,CI
INTEGER(KIND=8)                :: SUMI

COMMON/DATA/ AI,BI,CI
!$OMP THREADPRIVATE (/DATA/)

!$OMP PARALLEL
  FORALL(I=1:N,J=1:N) AI(I,J) = (I-N/2)**2+(J+N/2)
  FORALL(I=1:N,J=1:N) BI(I,J) = 3-((I/2)+(J-N/2)**2)
!$OMP MASTER
  NTHREADS=8
!$  NTHREADS=OMP_GET_NUM_THREADS()
!$OMP END MASTER
!$OMP END PARALLEL

!$OMP PARALLEL DEFAULT(PRIVATE),COPYIN(AI,BI),SHARED(NTHREADS)
!$OMP DO
  DO I=1,NTHREADS
    CALL IMAT_MUL(SUMI)
  ENDDO
!$OMP END DO
!$OMP END PARALLEL

END

```

For information on using sentinels, see Conditional compilation in the *XL Fortran Language Reference*.

---

## Setting runtime options

When you write parallel code, set the necessary `XLSMPOPTS` environment variables, and the environment variables for OpenMP.

### XLSMPOPTS

The `XLSMPOPTS` environment variable allows you to specify options that affect SMP execution. You can declare `XLSMPOPTS` by using the following `ksh` command format:

```

▶▶ XLSMPOPTS= [ " ] runtime_option_name = option_setting [ " ] ▶▶

```

You can specify option names and settings in uppercase or lowercase. You can add blanks before and after the colons and equal signs to improve readability. However, if the `XLSMPOPTS` option string contains imbedded blanks, you must enclose the entire option string in double quotation marks (").

You can specify the following runtime options with the `XLSMPOPTS` environment variable:

## Scheduling options

When the SMP run time is used to divide the iteration space of a loop, either through auto-parallelization or OpenMP **FOR/DO** loops, a scheduling algorithm is used to assign iterations to the threads in the parallel region. Each thread receives and executes a contiguous range of iterations, which is called a block or a chunk. Threads might finish their blocks of work at different speeds. After completing the assigned work, threads can be assigned more work or go to sleep. The chunk size can be controlled in some algorithms; doing so is a trade-off between overhead and load balancing.

### **schedule=static[=*n*]**

The iteration space is divided into blocks of *n* contiguous iterations. The final block might have fewer than *n* iterations. If *n* is unspecified, its default value is  $\text{FLOOR}(\text{number\_of\_iterations} / \text{number\_of\_threads})$ . The first  $\text{REMAINDER}(\text{number\_of\_iterations} / \text{number\_of\_threads})$  chunks have one more iteration. Each thread is assigned a separate chunk.

The blocks are assigned in a round-robin fashion to threads in the parallel region until there are no remaining blocks. A thread that completes all its blocks goes to sleep. This is also known as block-cyclic scheduling, or cyclic scheduling when *n* has the value 1.

### **schedule=dynamic[=*n*]**

The iteration space is divided into chunks that contain *n* contiguous iterations each. The final chunk might contain fewer than *n* iterations. If *n* is not specified, the chunk contains one iteration.

Each thread is initially assigned one chunk. After threads complete their assigned chunks, they are assigned remaining chunks on a "first-come, first-do" basis.

### **schedule=affinity[=*n*]**

The iteration space is divided into number-of-thread-in-parallel-region partitions. Each partition has  $\text{CEILING}(\text{number-of-iterations} / \text{number-of-thread-in-parallel-region})$  contiguous iterations. The final partition might have fewer iterations. The partitions are further divided into blocks, each with *n* iterations. If *n* is unspecified, its default value is  $\text{CEILING}(\text{number-of-iterations-in-partition} / 2)$ ; that is, each partition is divided into two blocks.

Each thread is assigned a partition. Each thread completes blocks within its local partition until no blocks remain in its partition. If blocks remain in other partitions, but a thread completes all blocks in its local partition, the thread might complete blocks in another thread's partition. A thread goes to sleep if it completes its blocks and no blocks remain.

**Note:** This option has been deprecated and might be removed in a future release. Instead, you can use the **guided** option.

### **schedule=guided[=*n*]**

The iteration space is divided into blocks of successively smaller size. Each block is sized to the larger of *n* and  $\text{CEILING}(\text{number-of-iterations-remaining} / \text{number-of-thread-in-parallel-region})$ . The final chunk might contain fewer than *n* iterations. If *n* is unspecified, its default value is 1.

Each thread is initially assigned one block. As threads complete their work, they are assigned remaining blocks on a "first-come, first-serve" basis. A thread goes to sleep if it completes its blocks and no blocks remain.

#### **schedule=auto**

The compiler and runtime might select any algorithm to assign work to threads. A different algorithm might be selected for different loops. In addition, a different algorithm might be selected if the run time is updated.

The **OMP\_SCHEDULE** environment variable affects only the constructs with a **schedule (runtime)** clause specified.

### **Parallel execution options**

#### **parthds=num**

Specifies the number of threads (*num*) to be used for parallel execution of code that you compiled with the **-qsmp** option. By default, this is equal to the number of online processors. There are some applications that cannot use more than some maximum number of processors. There are also some applications that can achieve performance gains if they use more threads than there are processors.

This option allows you full control over the number of execution threads. The default value for *num* is 1 if you did not specify **-qsmp**. Otherwise, it is the number of online processors on the machine. For more information, see the **NUM\_PARTHDS** intrinsic function in the *XL Fortran Language Reference*.

#### **usrthds=num**

Specifies the maximum number of threads (*num*) that you expect your code will explicitly create if the code does explicit thread creation. The default value for *num* is 0. For more information, see the **NUM\_PARTHDS** intrinsic function in the *XL Fortran Language Reference*.

#### **stack=num**

Specifies the largest amount of space in bytes (*num*) that a thread's stack will need. The default value for *num* is 4194304.

Set **stack=num** so it is within the acceptable upper limit. *num* can be up to 256 MB for 32-bit mode, or up to the limit imposed by system resources for 64-bit mode. An application that exceeds the upper limit may cause a segmentation fault.

#### **stackcheck[=num]**

Enables stack overflow checking for worker threads at runtime. *num* is the size in bytes that you specify, and it must be a nonnull positive number. When the remaining stack size is less than *num*, a runtime warning message is issued. If you do not specify a value for *num*, the default value is 4096 bytes. Note that this option only has an effect when **-qsmp=stackcheck** has also been specified at compile time. See **-qsmp** in the *XL Fortran Compiler Reference* for more information.

#### **startproc=cpu\_id**

Enables thread binding and specifies the *cpu\_id* to which the first thread binds. If the value provided is outside the range of available processors, the SMP run time issues a warning message and no threads are bound.

**procs**=*cpu\_id*[,*cpu\_id*,...]

Enables thread binding and specifies a list of *cpu\_id* to which the threads are bound.

**stride**=*num*

Specifies the increment used to determine the *cpu\_id* to which subsequent threads bind. *num* must be greater than or equal to 1. If the value provided causes a thread to bind to a CPU outside the range of available processors, a warning message is issued and no threads are bound.

**bind**=*SDL*=*n1,n2,n3*

Specifies different system detail levels to bind threads by using the Resource Set API. This suboption supports binding a thread to multiple logical processors.

*SDL* stands for System Detail Level and must be one of MCM, L2CACHE, PROC\_CORE, or PROC. If the *SDL* value is not specified, or an incorrect *SDL* value is specified, the SMP runtime issues an error message.

The list of three integers *n1,n2,n3* determines how to divide threads among resources (one of *SDL*s). *n1* is the starting *resource\_id*, *n2* is the number of requested resources, and *n3* is the stride, which specifies the increment used to determine the next *resource\_id* to bind. *n1,n2,n3* must all be specified; otherwise, the default binding rules apply.

When the number of resources specified in **bind** is greater than the number of threads, the extra resources are ignored.

When the number of threads *t* is greater than the number of resources *x*, *t* threads are divided among *x* resources according to the following formula:

The  $\text{ceil}(t/x)$  threads are bound to the first  $(t \bmod x)$  resources. The  $\text{floor}(t/x)$  threads are bound to the remaining resources.

With the **XLSMPOPTS** environment variable being set as in the following example, a program runs with 16 threads. It binds threads to PROC 0, 2, 4, 6, 8, 10, 12, 14, 16, 18, 20, 22, 24, 26, 28, 30.

```
XLSMPOPTS="bind=PROC=0,16,2"
```

#### Notes:

- The **bind** suboption takes precedence over the **startproc/stride** and **procs** suboptions. However, **bindlist** takes precedence over **bind**.
- Resource Set can only be used by a user account with the CAP\_NUMA\_ATTACH and CAP\_PROPAGATE capabilities. These capabilities are set on a per-user basis by using the **chuser** command as follows:  

```
chuser "capabilities=CAP_PROPAGATE,CAP_NUMA_ATTACH" username
```
- If the *resource\_id* specified in **bind** is outside the range of 0 to 2147483647, the default binding rules apply.
- The SMP runtime verifies that the *resource\_id* exists. If the *resource\_id* does not exist, the thread is left unbound.
- If you change the number of threads inside the program, for example, through **omp\_set\_num\_threads()** or **num\_threads** clause, the following situation occurs:

- If the number of threads in the application is increased, rebinding takes place based on the environment variable settings.
- If the number of threads is reduced after binding, the original binding remains.

**bindlist**=*SDL=i1,i2,...ix*

Specifies different system detail levels to bind threads by using the Resource Set API. This suboption supports binding a thread to multiple logical processors.

*SDL* stands for System Detail Level and must be one of MCM, L2CACHE, PROC\_CORE, or PROC. If the *SDL* value is not specified, or an incorrect *SDL* value is specified, the SMP runtime issues an error message.

The list of  $x$  integers  $i1,i2...ix$  enumerates the resources (one of *SDL*s) to be used during binding. When the number of integers in the list is greater than or equal to the number of threads, the position in the list determines the thread ID that will be bound to the resource.

When the number of resources specified in **bindlist** is greater than the number of threads, the extra resources are ignored.

When the number of threads  $t$  is greater than the number of resources  $x$ ,  $t$  threads are divided among  $x$  resources according to the following formula:

The  $ceil(t/x)$  threads are bound to the first  $(t \bmod x)$  resources. The  $floor(t/x)$  threads will be bound to the remaining resources.

For example:

```
XLSMPOPTS="bindlist=MCM=0,1,2,3"
```

This example code shows that threads are bound to MCM 0,1,2,3. When the program runs with four threads, thread 0 is bound to MCM 0, thread 1 is bound to MCM 1, thread 2 is bound to MCM 2, and thread 3 is bound to MCM 3. When the program runs with six threads, threads 0 and 1 are bound to MCM 0, threads 2 and 3 are bound to MCM 1, thread 4 is bound to MCM 2, and thread 5 is bound to MCM 3.

With the **XLSMPOPTS** environment variable being set as in the following example, a program runs with eight (or fewer) threads. It binds all even-numbered threads to L2CACHE 0 and all odd-numbered threads to L2CACHE 1.

```
XLSMPOPTS="bindlist=L2CACHE=0,1,0,1,0,1,0,1"
```

#### Notes:

- The **bindlist** suboption takes precedence over the **startproc/stride**, **procs**, and **bind** suboptions.
- Resource Set can only be used by a user account with the CAP\_NUMA\_ATTACH and CAP\_PROPAGATE capabilities. These capabilities are set on a per-user basis by using the **chuser** command as follows:  

```
chuser "capabilities=CAP_PROPAGATE,CAP_NUMA_ATTACH" username
```
- The SMP runtime verifies that the thread ID specified for a resource is not less than 0 and greater than the available resources. Otherwise, the thread is left unbound.

- If you change the number of threads inside the program, for example, through `omp_set_num_threads()` or `num_threads` clause, the following situation occurs:
  - If the number of threads in the application is increased, rebinding takes place based on the environment variable settings.
  - If the number of threads is reduced after binding, the original binding remains.

### Performance tuning options

When a thread completes its work and there is no new work to do, it can go into either a "busy-wait" state or a "sleep" state. In "busy-wait", the thread keeps executing in a tight loop looking for additional new work. This state is highly responsive but harms the overall utilization of the system. When a thread sleeps, it completely suspends execution until another thread signals it that there is work to do. This state provides better utilization of the system but introduces extra overhead for the application.

The `xlsmp` runtime library routines use both "busy-wait" and "sleep" states in their approach to waiting for work. You can control these states with the `spins`, `yields`, and `delays` options.

During the busy-wait search for work, the thread repeatedly scans the work queue up to *num* times, where *num* is the value that you specified for the option `spins`. If a thread cannot find work during a given scan, it intentionally wastes cycles in a delay loop that executes *num* times, where *num* is the value that you specified for the option `delays`. This delay loop consists of a single meaningless iteration. The length of actual time this takes will vary among processors. If the value `spins` is exceeded and the thread still cannot find work, the thread will yield the current time slice (time allocated by the processor to that thread) to the other threads. The thread will yield its time slice up to *num* times, where *num* is the number that you specified for the option `yields`. If this value *num* is exceeded, the thread will go to sleep.

In summary, the ordered approach to looking for work consists of the following steps:

1. Scan the work queue for up to `spins` number of times. If no work is found in a scan, then loop `delays` number of times before starting a new scan.
2. If work has not been found, then yield the current time slice.
3. Repeat the above steps up to `yields` number of times.
4. If work has still not been found, then go to sleep.

The syntax for specifying these options is as follows:

`spins[=num]`

where *num* is the number of spins before a yield. The default value for `spins` is **100**.

`yields[=num]`

where *num* is the number of yields before a sleep. The default value for `yields` is **10**.

`delays[=num]`

where *num* is the number of delays while busy-waiting. The default value for `delays` is **500**.

Zero is a special value for `spins` and `yields`, as it can be used to force complete busy-waiting. Normally, in a benchmark test on a dedicated system, you would set both options to zero. However, you can set them individually to achieve other effects.

For instance, on a dedicated 8-way SMP, setting these options to the following:  
`parthds=8 : schedule=dynamic=10 : spins=0 : yields=0`

results in one thread per CPU, with each thread assigned chunks consisting of 10 iterations each, with busy-waiting when there is no immediate work to do.

You can also use the environment variables **SPINLOOPTIME** and **YIELDLOOPTIME** to tune performance. Refer to the *AIX Performance Management* for more information on these variables.

### Options to enable and control dynamic profiling

You can use dynamic profiling to reevaluate the compiler's decision to parallelize loops in a program. The three options you can use to do this are: **parthreshold**, **seqthreshold**, and **profilefreq**.

#### **parthreshold=num**

Specifies the time, in milliseconds, below which each loop must execute serially. If you set **parthreshold** to 0, every loop that has been parallelized by the compiler will execute in parallel. The default setting is 0.2 milliseconds, meaning that if a loop requires fewer than 0.2 milliseconds to execute in parallel, it should be serialized.

Typically, **parthreshold** is set to be equal to the parallelization overhead. If the computation in a parallelized loop is very small and the time taken to execute these loops is spent primarily in the setting up of parallelization, these loops should be executed sequentially for better performance.

#### **seqthreshold=num**

Specifies the time, in milliseconds, beyond which a loop that was previously serialized by the dynamic profiler should revert to being a parallel loop. The default setting is 5 milliseconds, meaning that if a loop requires more than 5 milliseconds to execute serially, it should be parallelized.

**seqthreshold** acts as the reverse of **parthreshold**.

#### **profilefreq=num**

Specifies the frequency with which a loop should be revisited by the dynamic profiler to determine its appropriateness for parallel or serial execution. Loops in a program can be data dependent. The loop that was chosen to execute serially with a pass of dynamic profiling may benefit from parallelization in subsequent executions of the loop, due to different data input. Therefore, you need to examine these loops periodically to reevaluate the decision to serialize a parallel loop at run time.

The allowed values for this option are the numbers from 0 to 32. If you set **profilefreq** to one of these values, the following results will occur.

- If **profilefreq** is 0, all profiling is turned off, regardless of other settings. The overheads that occur because of profiling will not be present.
- If **profilefreq** is 1, loops parallelized automatically by the compiler will be monitored every time they are executed.
- If **profilefreq** is 2, loops parallelized automatically by the compiler will be monitored every other time they are executed.
- If **profilefreq** is greater than or equal to 2 but less than or equal to 32, each loop will be monitored once every *n*th time it is executed.
- If **profilefreq** is greater than 32, then 32 is assumed.



It is important to note that dynamic profiling is not applicable to user-specified parallel loops (for example, loops for which you specified the **PARALLEL DO** directive).

## Environment variables for OpenMP

The following environment variables, which are included in the OpenMP standard, allow you to control the execution of parallel code.

**Note:** If you specify both the **XLSMPOPTS** environment variable and an OpenMP environment variable, the OpenMP environment variable takes precedence.

### **OMP\_DISPLAY\_ENV**

When a program that uses the OpenMP runtime is invoked and the **OMP\_DISPLAY\_ENV** environment variable is set, the OpenMP runtime displays the values of the internal control variables (ICVs) associated with the environment variables and the build-specific information about the runtime library.

**OMP\_DISPLAY\_ENV** is useful in the following cases:

- When the runtime library is statically linked with an OpenMP program, you can use **OMP\_DISPLAY\_ENV** to check the version of the library that is used during link time.
- When the runtime library is dynamically linked with an OpenMP program, you can use **OMP\_DISPLAY\_ENV** to check the library that is used at run time.
- You can use **OMP\_DISPLAY\_ENV** to check the current setting of the runtime environment.

By default, no information is displayed.

The syntax of this environment variable is as follows:

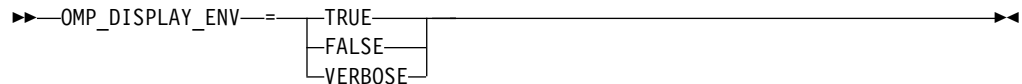

**Note:** The values **TRUE**, **FALSE**, **VERBOSE** are not case-sensitive.

#### **TRUE**

Displays the OpenMP version number defined by the **\_OPENMP** macro and the initial ICV values for the OpenMP environment variables.

#### **FALSE**

Instructs the runtime environment not to display any information.

#### **VERBOSE**

Displays build-specific information, ICV values associated with OpenMP environment variables, and the setting of the **XLSMPOPTS** environment variable.

## Examples

### Example 1

If you enter the **export OMP\_DISPLAY\_ENV=TRUE** command, you get output similar to the following example:

```

OPENMP DISPLAY ENVIRONMENT BEGIN
  OMP_DISPLAY_ENV='TRUE'

  _OPENMP='201107'
  OMP_DYNAMIC='FALSE'
  OMP_MAX_ACTIVE_LEVELS='5'
  OMP_NESTED='FALSE'
  OMP_NUM_THREADS='96'
  OMP_PROC_BIND='FALSE'
  OMP_SCHEDULE='STATIC,0'
  OMP_STACKSIZE='4194304'
  OMP_THREAD_LIMIT='96'
  OMP_WAIT_POLICY='PASSIVE'
OPENMP DISPLAY ENVIRONMENT END

```

## Example 2

If you enter the **export OMP\_DISPLAY\_ENV=VERBOSE** command, you will get output that is similar to the following example:

```

OPENMP DISPLAY AFFINITY BEGIN
  OMP_PLACES='{0},{1},{2},{3},{4},{5},{6},{7},{8},{9},{10}' cores
  THREADS_PER_PLACE='{1},{1},{1},{1},{1},{1},{1},{1},{1},{1},{1}'
OPENMP DISPLAY AFFINITY END

```

## Related information

“XLSMPOPTS” on page 90

“OMP\_PROC\_BIND” on page 101

## OMP\_DYNAMIC

The **OMP\_DYNAMIC** environment variable controls dynamic adjustment of the number of threads available for the execution of parallel regions.



If you set this environment variable to **TRUE**, the runtime environment can adjust the number of threads it uses for executing parallel regions so that it makes the most efficient use of system resources. If you set this environment variable to **FALSE**, dynamic adjustment is disabled.

The default value for **OMP\_DYNAMIC** is **FALSE**. If your code needs to use a specific number of threads to run correctly, you should disable dynamic thread adjustment.

The **omp\_set\_dynamic** subroutine takes precedence over the **OMP\_DYNAMIC** environment variable.

## Related information

“OMP\_PROC\_BIND” on page 101

## OMP\_MAX\_ACTIVE\_LEVELS

The **OMP\_MAX\_ACTIVE\_LEVELS** environment variable controls the maximum number of nested active parallel regions. The syntax is as follows:

▶▶—OMP\_MAX\_ACTIVE\_LEVELS=*n*————▶▶

*n* is the maximum number of nested active parallel regions. It must be a positive scalar integer. The maximum number that you can specify is 5.

### OMP\_NESTED

The **OMP\_NESTED** environment variable enables or disables nested parallelism. The syntax is as follows:

▶▶—OMP\_NESTED=

|       |
|-------|
| FALSE |
| TRUE  |

————▶▶

If you set this environment variable to **TRUE**, nested parallelism is enabled, which means that the runtime environment might deploy extra threads to form the team of threads for the nested parallel region. If you set this environment variable to **FALSE**, nested parallelism is disabled, which means nested parallel regions are serialized and run in the current thread.

The default value for **OMP\_NESTED** is **FALSE**.

The setting of the **omp\_set\_nested** subroutine overrides the **OMP\_NESTED** setting. The **OMP\_NESTED** setting overrides the setting of the **-qsmp=nested\_parallel\_nonested\_parallel** option.

**Note:** If the number of threads from all regions exceeds the number of available processors, your program might suffer performance degradation.

### OMP\_NUM\_THREADS

The **OMP\_NUM\_THREADS** environment variable sets the number of threads to use for parallel regions. The syntax of the environment variable is as follows:

▶▶—OMP\_NUM\_THREADS=*num\_list*————▶▶

*num\_list*

A list of one or more positive integer values separated by commas.

If you do not set the **OMP\_NUM\_THREADS** environment variable, the number of processors available is the default value to form a new team for the first encountered parallel construct. By default, any nested constructs are run by one thread.

If *num\_list* contains a single value, dynamic adjustment of the number of threads is enabled (**OMP\_DYNAMIC** is set to true), a parallel construct without a **NUM\_THREADS** clause is encountered, the value is the maximum number of threads that can be used to form a new team for the encountered parallel construct.

If *num\_list* contains a single value, dynamic adjustment of the number of threads is not enabled (**OMP\_DYNAMIC** is set to false), a parallel construct without a **NUM\_THREADS** clause is encountered, the value is the exact number of threads that can be used to form a new team for the encountered parallel construct.

If *num\_list* contains multiple values, dynamic adjustment of the number of threads is enabled (**OMP\_DYNAMIC** is set to true), a parallel construct without a

**NUM\_THREADS** clause is encountered, the first value is the maximum number of threads that can be used to form a new team for the encountered parallel construct. After the encountered construct is entered, the first value is removed and the remaining values form a new *num\_list*. The new *num\_list* is in turn used in the same way for any closely nested parallel constructs inside the encountered parallel construct.

If *num\_list* contains multiple values, dynamic adjustment of the number of threads is not enabled (**OMP\_DYNAMIC** is set to false), a parallel construct without a **NUM\_THREADS** clause is encountered, the first value is the exact number of threads that can be used to form a new team for the encountered parallel construct. After the encountered construct is entered, the first value is removed and the remaining values form a new *num\_list*. The new *num\_list* is in turn used in the same way for any closely nested parallel constructs inside the encountered parallel construct.

**Note:** If the number of parallel regions is equal to or greater than the number of values in *num\_list*, the **omp\_get\_max\_threads** routine returns the last value of *num\_list* in the parallel region.

If the number of threads requested exceeds the system resources available, the program stops.

The **omp\_set\_num\_threads** routine sets the first value of *num\_list*. The **omp\_get\_max\_threads** routine returns the first value of *num\_list*.

If you specify the number of threads for a given parallel region more than once with different settings, the compiler uses the following precedence order to determine which setting takes effect:

1. The number of threads set using the **NUM\_THREADS** clause takes precedence over that set using the **omp\_set\_num\_threads** routine.
2. The number of threads set using the **omp\_set\_num\_threads** routine takes precedence over that set using the **OMP\_NUM\_THREADS** environment variable.
3. The number of threads set using the **OMP\_NUM\_THREADS** environment variable takes precedence over that set using the **PARTHDS** suboption of the **XLSMPOPTS** environment variable.

**Note:** In a given parallel region, the **omp\_get\_max\_threads** routine returns the first value of *num\_list*, even though the actual number of threads running that parallel region might be different from the first value of *num\_list*.

The following example shows how you can set the **OMP\_NUM\_THREADS** environment variable.

```
export OMP_NUM_THREADS=5,10
export OMP_DYNAMIC=false

! OMP_GET_MAX_THREADS() returns 5 threads
!$omp parallel
! OMP_GET_MAX_THREADS() returns 10 threads
!$omp parallel
! OMP_GET_MAX_THREADS() returns 10 threads
!$omp parallel
! OMP_GET_MAX_THREADS() returns 10 threads
!$omp end parallel
!$omp end parallel
!$omp end parallel
```

## OMP\_PROC\_BIND

The **OMP\_PROC\_BIND** environment variable controls whether OpenMP threads can be moved between places.

### OMP\_PROC\_BIND syntax

►► OMP\_PROC\_BIND= TRUE  
FALSE ►►

#### TRUE

Binds the threads to places.

#### FALSE

Allows threads to be moved between places.

### Usage

The **OMP\_PROC\_BIND** and **XLSMPOPTS** environment variables interact with each other according to the following rules:

Table 20. Thread binding rule summary

| OMP_PROC_BIND settings   | XLSMPOPTS settings                                                     | Thread binding results                                                         |
|--------------------------|------------------------------------------------------------------------|--------------------------------------------------------------------------------|
| OMP_PROC_BIND is not set | XLSMPOPTS is not set                                                   | Threads are not bound.                                                         |
|                          | XLSMPOPTS is set to <b>startproc/stride, procs, bind, or bindlist</b>  | Threads are bound according to the settings in <b>XLSMPOPTS</b> .              |
|                          | XLSMPOPTS setting is invalid                                           | Threads are not bound.                                                         |
| OMP_PROC_BIND = TRUE     | XLSMPOPTS is not set                                                   | Threads are bound.                                                             |
|                          | XLSMPOPTS is set to <b>startproc/stride, procs, bind, or bindlist</b>  | Threads are bound according to the settings in <b>XLSMPOPTS</b> <sup>1</sup> . |
|                          | XLSMPOPTS setting is invalid                                           | Threads are bound.                                                             |
| OMP_PROC_BIND = FALSE    | XLSMPOPTS is not set                                                   | Threads are not bound.                                                         |
|                          | XLSMPOPTS is set ( <b>startproc/stride, procs, bind, or bindlist</b> ) |                                                                                |
|                          | XLSMPOPTS setting is invalid                                           |                                                                                |

#### Note:

1. If **procs** is set and the number of CPU IDs specified is smaller than the number of threads that are used by the program, the remaining threads are also bound to the listed CPU IDs but not in any particular order. If **XLSMPOPTS=startproc** is used, the value specified by **startproc** is smaller than the number of CPUs, and the value that is specified by **stride** causes a thread to bind to a CPU outside the range of available places, some of the threads are bound and some are not.

The **OMP\_PROC\_BIND** environment variable provides a portable way to control whether OpenMP threads can be migrated. The **startproc/stride, procs, bind, or bindlist** suboption of the **XLSMPOPTS** environment variable, which is an IBM extension, provides a finer control to bind OpenMP threads to places. If portability of your application is important, use only the **OMP\_PROC\_BIND** environment variable to control thread binding.

#### Related information:

“XLSMPOPTS” on page 90

## OMP\_SCHEDULE

The **OMP\_SCHEDULE** environment variable applies to the **PARALLEL DO** and work-sharing **DO** directives that have a schedule type of **RUNTIME**. The syntax is as follows:

```
▶▶—OMP_SCHEDULE=—sched_type—┬──▶▶  
                                └──,—chunk_size—┘
```

*sched\_type*

is either **AUTO**, **DYNAMIC**, **GUIDED**, or **STATIC**. See the “**SCHEDULE**” on page 179 clause for a description of these scheduling parameters.

*chunk\_size*

is a positive, scalar integer that represents the chunk size.

This environment variable is ignored for the **PARALLEL DO** and work-sharing **DO** directives that have a schedule type other than **RUNTIME**.

If you do not specify a schedule type either at compile time through a directive, or at run time through the **OMP\_SCHEDULE** environment variable or the **SCHEDULE** option of the **XLSPMPOPTS** environment variable, the default schedule type is **AUTO**, which delegates scheduling decision to the compiler and runtime system. You cannot specify *chunk\_size* when the schedule type is set to **AUTO**.

If you specify both the **SCHEDULE** option of the **XLSPMPOPTS** environment variable and the **OMP\_SCHEDULE** environment variable, the **OMP\_SCHEDULE** environment variable takes precedence.

The following examples show how you can set the **OMP\_SCHEDULE** environment variable:

```
export OMP_SCHEDULE="DYNAMIC"  
export OMP_SCHEDULE="GUIDED,4"  
export OMP_SCHEDULE="STATIC"  
export OMP_SCHEDULE="AUTO"
```

## OMP\_STACKSIZE

The **OMP\_STACKSIZE** environment variable specifies the size of the stack for threads created by the OpenMP run time. The syntax is as follows:

```
▶▶—OMP_STACKSIZE=—size—┬──▶▶  
                        └──sizeB──┘  
                        └──sizeK──┘  
                        └──sizeM──┘  
                        └──sizeG──┘
```

*size* is a positive integer that specifies the size of the stack for threads that are created by the OpenMP run time.

*"B"*, *"K"*, *"M"*, *"G"*

are letters that specify whether the given size is in Bytes, Kilobytes, Megabytes, or Gigabytes.

If only *size* is specified and none of *"B"*, *"K"*, *"M"*, *"G"* is specified, *size* is in Kilobytes by default. This environment variable does not control the size of the stack for the initial thread.

The value assigned to the `OMP_STACKSIZE` environment variable is case insensitive and might have leading and trailing white space. The following examples show how you can set the `OMP_STACKSIZE` environment variable.

```
export OMP_STACKSIZE="10M"  
export OMP_STACKSIZE=" 10 M "
```

If the value of `OMP_STACKSIZE` is not set, the initial value is set to the default value. The default value is 4194304B. The maximum value for 32-bit mode is 256M. For 64-bit mode, the maximum is up to the limit imposed by system resources..

If the compiler cannot deliver the stack size specified by the environment variable, or if `OMP_STACKSIZE` does not conform to the valid format, the compiler sets the environment variable to the default value.

The `OMP_STACKSIZE` environment variable takes precedence over the `stack` suboption of the `XLSPMPOPTS` environment variable.

### **OMP\_THREAD\_LIMIT**

The `OMP_THREAD_LIMIT` environment variable sets the number of OpenMP threads to use for the whole program. The syntax is as follows:

►► `OMP_THREAD_LIMIT=--n` ◀◀

*n* The number of OpenMP threads to use for the whole program. It must be a positive scalar integer that is less than 65536.

### **Usage**

When `OMP_THREAD_LIMIT=1`, the parallel regions are run sequentially rather than in parallel. However, when `OMP_THREAD_LIMIT` is much smaller than the number of threads that are required in the program, the parallel region might still run in parallel but with less number of threads. When there are nested parallel regions, some parallel regions might run in parallel, some might run sequentially, and some might run in parallel but with threads that are recycled from other regions.

If the `OMP_THREAD_LIMIT` environment variable is not set and the `OMP_NUM_THREADS` environment variable is set to a single value, the default value for `OMP_THREAD_LIMIT` is the value of `OMP_NUM_THREADS` or the number of available processors, whichever is greater.

If the `OMP_THREAD_LIMIT` environment variable is not set and the `OMP_NUM_THREADS` environment variable is set to a list, the default value for `OMP_THREAD_LIMIT` is the multiplication of all the numbers in the list or the number of available processors, whichever is greater.

If neither the `OMP_THREAD_LIMIT` nor `OMP_NUM_THREADS` environment variable is set, the default value for `OMP_THREAD_LIMIT` is the number of available processors.

### **Related information**

“`OMP_NUM_THREADS`” on page 99

## OMP\_WAIT\_POLICY

The **OMP\_WAIT\_POLICY** environment variable provides hints about the preferred behavior of waiting threads during program execution. The syntax is as follows:

```
▶▶—OMP_WAIT_POLICY=—┌—PASSIVE—┐
                       │—ACTIVE— │
                       └──────────┘▶▶
```

Use **ACTIVE** if you want waiting threads to mostly be active. That is, the threads consume processor cycles while waiting. For example, waiting threads can spin while waiting. The **ACTIVE** wait policy is recommended for maximum performance on the dedicated machine.

Use **PASSIVE** if you want waiting threads to mostly be passive. That is, the threads do not consume processor cycles while waiting. For example, waiting threads can sleep or yield the processor to other threads.

The default value of **OMP\_WAIT\_POLICY** is **PASSIVE**.

**Note:** If you set the **OMP\_WAIT\_POLICY** environment variable and specify the **SPINS**, **YIELDS**, or **DELAYS** suboptions of the **XLSPMPOPTS** environment variable, **OMP\_WAIT\_POLICY** takes precedence.

---

## Optimizing your SMP code

Most IBM processors are capable of shared-memory parallel processing. Compile with **-qsmp** to generate the threaded code needed to exploit this capability. The option implies a **-O2** optimization level. The default behavior for the option without suboptions is to do automatic parallelization with optimization.

The most commonly used **-qsmp** suboptions are summarized in the following table.

Commonly used **-qsmp** suboptions

| Suboption         | Behavior                                                                                                                                                                                                                         |
|-------------------|----------------------------------------------------------------------------------------------------------------------------------------------------------------------------------------------------------------------------------|
| auto              | Instructs the compiler to automatically generate parallel code where possible without user assistance. This option also recognizes all the SMP directives.                                                                       |
| omp               | Enforces compliance with the OpenMP API for specifying explicit parallelism.                                                                                                                                                     |
| opt               | Instructs the compiler to optimize as well as parallelize. The optimization is equivalent to <b>-O2 -qhot</b> in the absence of other optimization options. The default setting of <b>-qsmp</b> is <b>-qsmp=auto:noomp:opt</b> . |
| <i>suboptions</i> | Other values for the suboption provide control over thread scheduling, nested parallelism, locking, and so on.                                                                                                                   |

Certain thread environment variables like **MALLOCMULTIHEAP**, **SPINLOOPTIME**, or **YIELDLOOPTIME** may improve application performance as well. For more information, see the information in the AIX Information Center at <http://publib.boulder.ibm.com/infocenter/pseries/v5r3/index.jsp>.

## Developing and running SMP applications

- By default, the parallelization performed is both user-directed and automatic. Use **-qsmp=omp:noauto** if you are compiling an OpenMP program and do not want automatic parallelization.



- Before using **-qsmp** with automatic parallelization, test your programs using optimization and **-qhot** in a single-threaded manner.
- Always use the reentrant compiler invocations (the **\_r** command invocations, like **xlfr\_r**) when using **-qsmp**.
- By default, the run time uses all available processors. Do not set the **XLSMPOPTS=PARHDS** or **OMP\_NUM\_THREADS** variables unless you want to use fewer than the number of available processors. You might want to set the number of executing threads to a small number or to 1 to ease debugging.
- If you are using a dedicated machine or node, consider setting **OMP\_WAIT\_POLICY** to **ACTIVE** or setting the **SPINS** and **YIELDS** variables (suboptions of **XLSMPOPTS**) to 0. Doing so prevents the operating system from intervening in the scheduling of threads across synchronization boundaries such as barriers.
- When debugging an SMP program, try using **-qsmp=noopt** (without **-O**) to make the debugging information produced by the compiler more precise. You can also use the **SNAPSHOT** directive to create additional program points for storage visibility by flushing registers to memory.

---

## An introduction to parallelization directives

These directives allow you to exert control over parallelization. For example, the **PARALLEL DO** directive specifies that the loop immediately following the directive should be run in parallel. All parallelization directives are comment form directives.

For more information on rules and syntax for comment form directives, see Comment and noncomment form directives in the *XL Fortran Language Reference*.

XL Fortran supports a number of SMP directives, divided as follows. To ensure the greatest portability of code, OpenMP directives are recommended where possible. Use the OpenMP *trigger\_constant*, **\$OMP** for OpenMP directives, but do not use this *trigger\_constant* with any other directive. OpenMP directives must not appear in **PURE** and **ELEMENTAL** procedures.

### Parallel region construct

Parallel constructs form the foundation of OpenMP based parallel execution in XL Fortran. The **PARALLEL/END PARALLEL** directive pair forms a basic parallel construct. Each time an executing thread enters a parallel region, it creates a team of threads and becomes master of that team. This allows parallel execution to take place within that construct by the threads in that team. The following directives are necessary for a parallel region:

|                 |                     |
|-----------------|---------------------|
| <b>PARALLEL</b> | <b>END PARALLEL</b> |
|-----------------|---------------------|

### Work-sharing constructs

Work-sharing constructs divide the execution of code enclosed by the construct between threads in a team. For work-sharing to take place, the construct must be enclosed within the dynamic extent of a parallel region. For further information on work-sharing constructs, see the following directives:

|                  |                      |
|------------------|----------------------|
| <b>DO</b>        | <b>END DO</b>        |
| <b>SECTIONS</b>  | <b>END SECTIONS</b>  |
| <b>WORKSHARE</b> | <b>END WORKSHARE</b> |

|        |            |
|--------|------------|
| SINGLE | END SINGLE |
|--------|------------|

## Combined parallel work-sharing constructs

A combined parallel work-sharing construct allows you to specify a parallel region that already contains a single work-sharing construct. These combined constructs are semantically identical to specifying a parallel construct enclosing a single work-sharing construct. For more information on implementing combined constructs, see the following directives:

|                    |                        |
|--------------------|------------------------|
| PARALLEL DO        | END PARALLEL DO        |
| PARALLEL SECTIONS  | END PARALLEL SECTIONS  |
| PARALLEL WORKSHARE | END PARALLEL WORKSHARE |

## Synchronization constructs

The following directives allow you to synchronize the execution of a parallel region by multiple threads in a team:

|          |              |
|----------|--------------|
| ATOMIC   |              |
| BARRIER  |              |
| CRITICAL | END CRITICAL |
| FLUSH    |              |
| ORDERED  | END ORDERED  |
| TASKWAIT |              |

## Other OpenMP directives

The following OpenMP directives provide additional SMP functionality:

|               |            |
|---------------|------------|
| MASTER        | END MASTER |
| TASK          | END TASK   |
| THREADPRIVATE |            |

## Non-OpenMP SMP directives

The following directives provide additional SMP functionality:

|           |             |
|-----------|-------------|
| DO SERIAL | THREADLOCAL |
| SCHEDULE  |             |

## Deprecated directive

The SMP directive listed in the following table has been deprecated and might be removed in a future release. Use the corresponding OpenMP directive or clause to obtain the same behavior.

*Table 21. Deprecated SMP directive*

| SMP directive name | OpenMP directive/clause name |
|--------------------|------------------------------|
| SCHEDULE           | SCHEDULE                     |

The following example shows how to replace the deprecated SMP **SCHEDULE** directive with the OpenMP **SCHEDULE** clause.

The original code that uses the SMP **SCHEDULE** directive is as follows:

```
program loop
  integer, parameter :: N=500
  integer :: i
!SMP$ SCHEDULE(STATIC)
  real :: arr(N)

!SMP$ parallel do
  do i=1, N
    arr(i) = real(i-1)
  enddo
end program
```

To obtain the same behavior, you can use the OpenMP **SCHEDULE** clause, as shown below:

```
program loop
  integer, parameter :: N=500
  integer :: i
  real :: arr(N)

!$OMP parallel do schedule(static)
  do i=1, N
    arr(i) = real(i-1)
  enddo
end program
```

---

## Detailed descriptions of parallelization directives

This section lists, in alphabetical order, all parallelization directives supported by XL Fortran.

For information about directive clauses, see “Directive clauses” on page 160.

### ATOMIC

#### Purpose

You can use the **ATOMIC** directive to access a specific memory location safely within a parallel region. When you use the **ATOMIC** directive, the compiler generates code to ensure that only one thread is accessing the memory location at a time to avoid errors that might occur from simultaneous reads or writes to the same memory location.

Atomic operations are useful when you create multithreaded or concurrent algorithms and data structures. Using atomic constructs, you can write more efficient concurrent algorithms with fewer locks.

An atomic construct supports the following kinds of atomic access:

- Atomic update

Updates the value of a variable atomically. Allows only one thread to write to a shared variable at a time, avoiding errors from simultaneous writes to the same variable.

- Atomic read

Reads the value of a variable atomically. The value of a shared variable can be read safely, avoiding the danger of reading an intermediate value of the variable when it is accessed simultaneously by a concurrent thread.

- Atomic write  
Writes the value of a variable atomically. The value of a shared variable can be written exclusively to avoid errors from simultaneous writes.
- Atomic capture  
Updates the value of a variable while capturing the original or final value of the variable atomically.

The **ATOMIC** directive takes effect only if you specify the **-qsmp** compiler option.

## Syntax

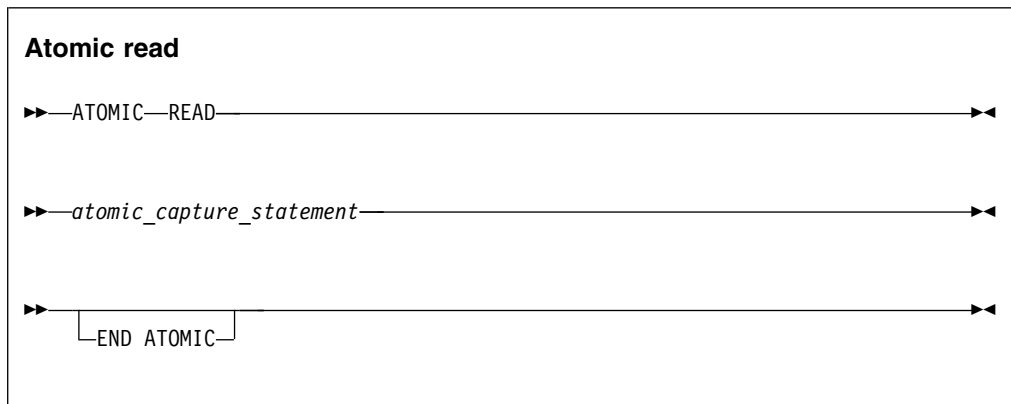
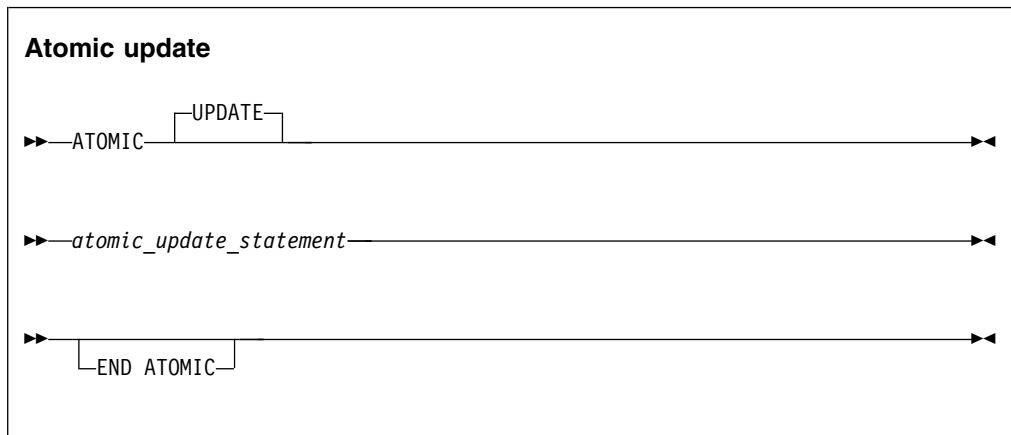

### Atomic write

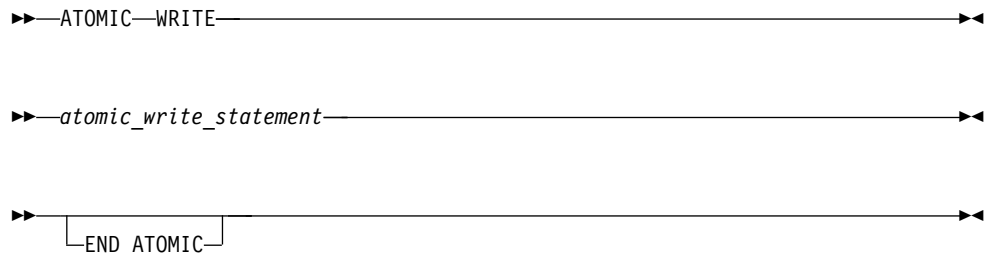

### Atomic capture

▶▶ ATOMIC CAPTURE ▶▶

▶▶ *atomic\_update\_statement* ▶▶

▶▶ *atomic\_capture\_statement* ▶▶

▶▶ END ATOMIC ▶▶

Or

▶▶ ATOMIC CAPTURE ▶▶

▶▶ *atomic\_capture\_statement* ▶▶

▶▶ *atomic\_update\_statement* ▶▶

▶▶ END ATOMIC ▶▶

Or

▶▶ ATOMIC CAPTURE ▶▶

▶▶ *atomic\_capture\_statement* ▶▶

▶▶ *atomic\_write\_statement* ▶▶

▶▶ END ATOMIC ▶▶

**Note:** The last form is to support atomic swap operations.

where:

*atomic\_update\_statement*

is one of the following forms:

*update\_variable* = *update\_variable* operator *expression*

*update\_variable* = *expression* operator *update\_variable*

*update\_variable* = *intrinsic*(*update\_variable*, *expression\_list*)

*update\_variable* = *intrinsic*(*expression\_list*, *update\_variable*)

*atomic\_write\_statement*

has the following form:

*update\_variable* = *expression*

*atomic\_capture\_statement*

has the following form:

*capture\_variable* = *update\_variable*

where:

*update\_variable*, *capture\_variable*

are both nonpointer, nonallocatable scalar variables of intrinsic type.

*intrinsic*

is one of **MAX**, **MIN**, **IAND**, **IOR** or **IEOR**.

*operator*

is one of **+**, **-**, **\***, **/**, **.AND.**, **.OR.**, **.EQV.**, **.NEQV.** or **.XOR.**

*expression*

is a scalar expression that does not reference *update\_variable*.

*expression\_list*

is a comma-separated, non-empty list of scalar expressions that do not reference *update\_variable*.

**Note:** If the intrinsic is **IAND**, **IOR**, or **IEOR**, *expression\_list* can only contain one expression.

## Rules

An **ATOMIC** directive without a clause is equivalent to atomic update, and applies only to the statement that immediately follows it.

All accesses to a certain storage location throughout a concurrent program must be atomic. A non-atomic access to a memory location might break the expected atomic behavior of all atomic accesses to that storage location.

The *expression* in an atomic statement is not evaluated atomically. You must ensure that no race conditions exist in the calculation.

Within the entire program, if you use the **ATOMIC** directive to make references to the storage location of an *update\_variable*, all these references must have the same type and type parameters.

*capture\_variable*, *expression*, and *expression\_list* must not access the same storage location as *update\_variable*.

For atomic capture access, the operation of writing the captured value to the storage location represented by *capture\_variable* is not atomic.

The function *intrinsic*, the operator *operator*, and the assignment must be the intrinsic function, operator and assignment, and not a redefined intrinsic function, defined operator or defined assignment.

## Examples

**Example 1:** In this example, multiple threads are updating a counter. **ATOMIC** is used to ensure that no updates are lost.

```

PROGRAM P
  R = 0.0
  !$OMP PARALLEL DO SHARED(R)
    DO I = 1, 10
      !$OMP ATOMIC
        R = R + 1.0
      END DO
    PRINT *,R
  END PROGRAM P

```

Expected output:

10.0

**Example 2:** In this example, an **ATOMIC** directive is required, because it is uncertain which element of array Y is updated in each iteration.

```

PROGRAM P
  INTEGER, DIMENSION(10) :: Y, INDEX
  INTEGER B

  Y = 5
  READ(*,*) INDEX, B
  !$OMP PARALLEL DO SHARED(Y)
    DO I = 1, 10
      !$OMP ATOMIC
        Y(INDEX(I)) = MIN(Y(INDEX(I)),B)
      END DO
    PRINT *, Y
  END PROGRAM P

```

Input data:

10 10 8 8 6 6 4 4 2 2 4

Expected output:

5 4 5 4 5 4 5 4 5 4

**Example 3:** This example demonstrates the usage of atomic capture.

```

FUNCTION fnc(upper) RESULT(ret)
  INTEGER, INTENT(IN) :: upper
  INTEGER :: ret
  INTEGER, SAVE :: iter = 0

  !$OMP ATOMIC CAPTURE
    iter = iter + 1
    ret = iter
  !$OMP END ATOMIC

  IF (ret .GT. upper) THEN
    ret = -1
  ENDIF
END FUNCTION fnc

```

**Related reference:**

“CRITICAL / END CRITICAL” on page 114

“PARALLEL / END PARALLEL” on page 126



See -qsmp in the Compiler Reference



# BARRIER

## Purpose

The **BARRIER** directive enables you to synchronize all threads of a team. When a thread encounters a **BARRIER** directive, it will not execute beyond the **BARRIER** until all other threads in the team complete all explicit tasks in the region.

## Type

The **BARRIER** directive only takes effect if you specify the **-qsmp** compiler option.

## Syntax

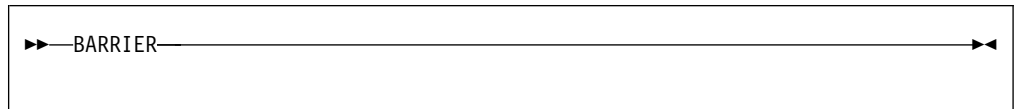

## Rules

A **BARRIER** region binds to the closest enclosing **PARALLEL** region.

A **BARRIER** region must not be closely nested inside a **CRITICAL**, **MASTER**, **ORDERED**, **TASK** or work-sharing region.

All threads of the team which are executing the binding parallel region must execute the **BARRIER** region, and they must not continue execution beyond the **BARRIER** until they complete execution of all explicit tasks that are bound to this parallel region.

All **BARRIER** regions and work-sharing region must be encountered in the same order by all threads in the team.

Each **BARRIER** region must be encountered by all threads in a team or by none at all.

In addition to synchronizing the threads in a team, the **BARRIER** directive implies the **FLUSH** directive without the *variable\_name\_list*.

## Examples

An example of the **BARRIER** construct binding to the **PARALLEL** construct. Note: To calculate *C*, we need to ensure that *A* and *B* have been completely assigned to, so threads need to wait.

```
      SUBROUTINE SUB1
      INTEGER A(1000), B(1000), C(1000)
!$OMP PARALLEL
!$OMP DO
      DO I = 1, 1000
        A(I) = SIN(I*2.5)
      END DO
!$OMP END DO NOWAIT
!$OMP DO
      DO J = 1, 10000
        B(J) = X + COS(J*5.5)
      END DO
!$OMP END DO NOWAIT
      ...
```



The same lock protects all **CRITICAL** constructs that do not have an explicit *lock\_name*. In other words, the compiler will assign the same *lock\_name*, thereby ensuring that only one thread enters any unnamed **CRITICAL** construct at a time.

The *lock\_name* must not share the same name as any local entity of Class 1.

It is illegal to branch into or out of a **CRITICAL** construct.

The **CRITICAL** construct may appear anywhere in a program.

Although it is possible to nest a **CRITICAL** construct within a **CRITICAL** region, a deadlock situation may result. The **-qsmp=rec\_locks** compiler option can be used to prevent deadlocks. See the *XL Fortran Compiler Reference* for more information. The OpenMP API does not allow nested **CRITICAL** regions to have the same name.

**CRITICAL** and **END CRITICAL** directives imply the **FLUSH** directive without the *variable\_name\_list*.

 A **CYCLE** statement must not appear within a **CRITICAL** construct if it belongs to an outer construct.

An **EXIT** statement must not appear within a **CRITICAL** construct if it belongs to that construct or an outer construct. 

## Examples

**Example 1:** This example illustrates the use of a **CRITICAL** construct to update a shared variable inside a parallel region. The **CRITICAL** construct restricts only one thread to execute the code at a time.

```
      EXPR=0
!$OMP PARALLEL DO PRIVATE (I)
      DO I = 1, 100
!$OMP   CRITICAL
          EXPR = EXPR + A(I) * I
!$OMP   END CRITICAL
      END DO
```

**Example 2:** An example specifying a *lock\_name* on the **CRITICAL** construct.

```
!$OMP PARALLEL DO PRIVATE(T)
      DO I = 1, 100
          T = B(I) * B(I-1)
!$OMP   CRITICAL (LOCK)
          SUM = SUM + T
!$OMP   END CRITICAL (LOCK)
      END DO
```

### Related reference:

“**ATOMIC**” on page 107

“**FLUSH**” on page 120

 See Global entity in the Language Reference

 See Local entity in the Language Reference

“**PARALLEL / END PARALLEL**” on page 126

 See **-qsmp** in the Compiler Reference

## DO / END DO

### Purpose

The **DO** (work-sharing) construct enables you to divide the execution of the loop among the members of the team that encounter it. The **END DO** directive enables you to indicate the end of a **DO** loop that is specified by the **DO** (work-sharing) directive.

The **DO** (work-sharing) and **END DO** directives only take effect when you specify the **-qsmp** compiler option.

### Syntax

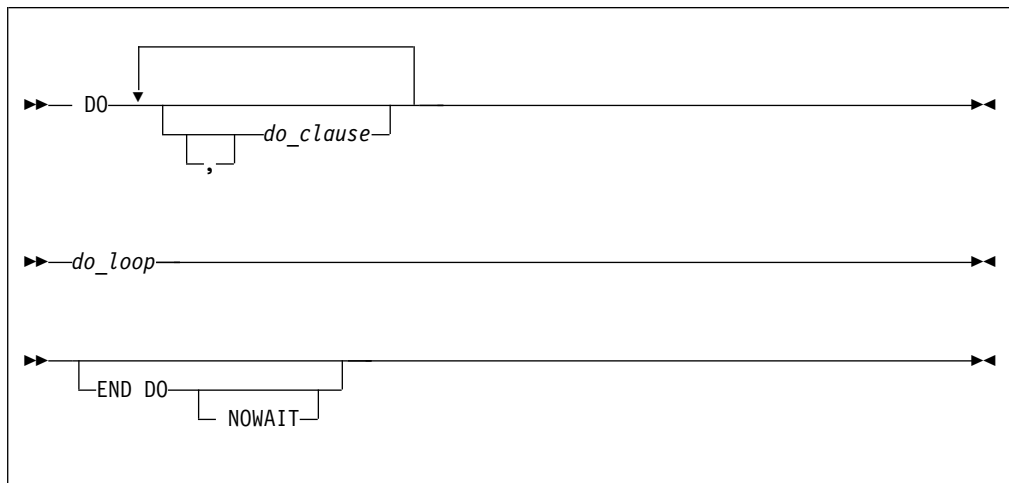

where *do\_clause* is:



*collapse\_clause*

See — “COLLAPSE” on page 161.

*firstprivate\_clause*

See — “FIRSTPRIVATE” on page 168.

*lastprivate\_clause*

See — “LASTPRIVATE” on page 170.

*ordered\_clause*

See — “ORDERED” on page 173

*private\_clause*

See — “PRIVATE” on page 174.

*reduction\_clause*

See — “REDUCTION” on page 176

*schedule\_clause*

See — “SCHEDULE” on page 179

## Rules

The first noncomment line (not including other directives) that follows the **DO** (work-sharing) directive must be a **DO** loop. This line cannot be an infinite **DO** or **DO WHILE** loop. The **DO** (work-sharing) directive applies only to the **DO** loop that is immediately following the directive, and not to any nested **DO** loops, unless the **COLLAPSE** clause is specified.

The **END DO** directive is optional. If you use the **END DO** directive, it must immediately follow the end of the **DO** loop.

You may have a **DO** construct that contains several **DO** statements. If the **DO** statements share the same **DO** termination statement, and an **END DO** directive follows the construct, you can only specify a work-sharing **DO** directive for the outermost **DO** statement of the construct.

If you specify **NOWAIT** on the **END DO** directive, a thread that completes its iterations of the loop early will proceed to the instructions following the loop. The thread will not wait for the other threads of the team to complete the **DO** loop. If you do not specify **NOWAIT** on the **END DO** directive, each thread will wait for all other threads within the same team at the end of the **DO** loop.

If you do not specify the **NOWAIT** clause, the **END DO** directive implies the **FLUSH** directive without the *variable\_name\_list*.

All threads in the team must encounter the **DO** (work-sharing) directive if any thread encounters it. A **DO** loop must have the same loop boundary and step value for each thread in the team. All work-sharing constructs and **BARRIER** directives that are encountered must be encountered in the same order by all threads in the team.

A **DO** (work-sharing) directive must not appear within a **CRITICAL**, **MASTER**, or **ORDERED** region. In addition, it must not appear within a work-sharing region or a **TASK** region unless it is bound to another parallel region.

You cannot follow a **DO** (work-sharing) directive by another **DO** (work-sharing) directive. You can only specify one **DO** (work-sharing) directive for a given **DO** loop.

The **DO** (work-sharing) directive cannot appear with either an **INDEPENDENT** or **DO SERIAL** directive for a given **DO** loop.

To ensure that the same assignment of logical iteration numbers to threads is used in two work-sharing loop regions, you can use the **STATIC** schedule of the **SCHEDULE** clause. For details, see “SCHEDULE” on page 179.

## Examples

**Example 1:** An example of several independent **DO** loops within a **PARALLEL** construct. No synchronization is performed after the first work-sharing **DO** loop, because **NOWAIT** is specified on the **END DO** directive.

```
!$OMP PARALLEL
!$OMP DO
    DO I = 2, N
        B(I) = (A(I) + A(I-1)) / 2.0
    END DO
!$OMP END DO NOWAIT
!$OMP DO
    DO J = 2, N
        C(J) = SQRT(REAL(J*J))
    END DO
!$OMP END DO
    C(5) = C(5) + 10
!$OMP END PARALLEL
END
```

**Example 2:** An example of **SHARED**, and **SCHEDULE** clauses.

```
!$OMP PARALLEL SHARED(A)
!$OMP DO SCHEDULE(STATIC,10)
    DO I = 1, 1000
        A(I) = I * 4
    END DO
!$OMP END DO
!$OMP END PARALLEL
```

**Example 3:** An example of both a **MASTER** and a **DO** (work-sharing) directive that bind to the closest enclosing **PARALLEL** directive.

```
!$OMP PARALLEL DEFAULT(PRIVATE), SHARED(X)
    Y = 100
!$OMP MASTER
    PRINT *, Y
!$OMP END MASTER
!$OMP DO
    DO I = 1, 10
        X(I) = I
        X(I) = X(I) + Y
    END DO
!$OMP END PARALLEL
END
```

**Example 4:** An example of both the **FIRSTPRIVATE** and the **LASTPRIVATE** clauses on **DO** (work-sharing) directives.

```
    X = 100

!$OMP PARALLEL PRIVATE(I), SHARED(X,Y)
!$OMP DO FIRSTPRIVATE(X), LASTPRIVATE(X)
    DO I = 1, 80
        Y(I) = X + I
        X = I
    END DO
!$OMP END PARALLEL
END
```

### Related reference:

“COLLAPSE” on page 161

 See **DO** in the Language Reference

“**DO SERIAL**” on page 119

“FLUSH” on page 120



See INDEPENDENT in the Language Reference

“ORDERED / END ORDERED” on page 124

“PARALLEL / END PARALLEL” on page 126

“PARALLEL DO / END PARALLEL DO” on page 128

## DO SERIAL

### Purpose

The **DO SERIAL** directive indicates to the compiler that the **DO** loop that is immediately following the directive must not be parallelized. This directive is useful in blocking automatic parallelization for a particular **DO** loop. The **DO SERIAL** directive only takes effect if you specify the **-qsmp** compiler option.

### Syntax

```
▶▶—DO SERIAL—▶▶
```

### Rules

The first noncomment line (not including other directives) that is following the **DO SERIAL** directive must be a **DO** loop. The **DO SERIAL** directive applies only to the **DO** loop that immediately follows the directive and not to any loops that are nested within that loop.

You can only specify one **DO SERIAL** directive for a given **DO** loop. The **DO SERIAL** directive must not appear with the **DO** (work-sharing), or **PARALLEL DO** directive on the same **DO** loop.

White space is optional between **DO** and **SERIAL**.

You should not use the OpenMP trigger constant with this directive.

### Examples

**Example 1:** An example with nested **DO** loops where the inner loop (the **J** loop) is not parallelized.

```
!$OMP PARALLEL DO PRIVATE(S,I), SHARED(A)
  DO I=1, 500
    S=0
    !SMP$ DOSERIAL
    DO J=1, 500
      S=S+1
    ENDDO
    A(I)=S+I
  ENDDO
```

**Example 2:** An example with the **DOSERIAL** directive applied in nested loops. In this case, if automatic parallelization is enabled the **I** or **K** loop may be parallelized.

```

      DO I=1, 100
!SMP$ DOSERIAL
      DO J=1, 100
        DO K=1, 100
          ARR(I,J,K)=I+J+K
        ENDDO
      ENDDO
    ENDDO

```

**Related reference:**

“DO / END DO” on page 116



See DO in the Language Reference

“PARALLEL DO / END PARALLEL DO” on page 128



See -qdirective in the Compiler Reference



See -qsmp in the Compiler Reference

## FLUSH

### Purpose

The **FLUSH** directive ensures that each thread has access to data generated by other threads. This directive is required because the compiler may keep values in processor registers if a program is optimized. The **FLUSH** directive ensures that the memory images that each thread views are consistent.

The **FLUSH** directive only takes effect if you specify the **-qsmp** compiler option.

You might be able to improve the performance of your program by using the **FLUSH** directive instead of the **VOLATILE** attribute. The **VOLATILE** attribute causes variables to be flushed after every update and before every use, while **FLUSH** causes variables to be written to or read from memory only when specified.

### Syntax

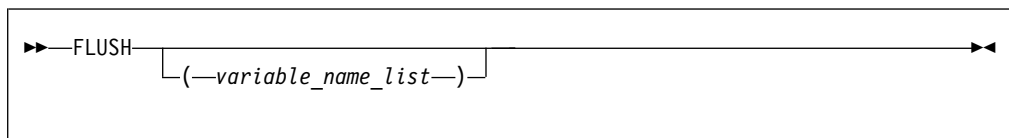

### Rules

You can specify this directive anywhere in your code; however, if you specify it outside a parallel region, it is ignored.

If you specify a *variable\_name\_list*, only the variables in that list are written to or read from memory (assuming that they have not been written or read already). All variables in the *variable\_name\_list* must be at the current scope and must be thread visible. Thread visible variables can be any of the following:

- Globally visible variables (common blocks and module data)
- Local and host-associated variables with the **SAVE** attribute
- Local variables without the **SAVE** attribute that are specified in a **SHARED** clause in a parallel region within the subprogram



- Local variables without the **SAVE** attribute that have had their addresses taken
- All pointer dereferences
- Dummy arguments

If an item or a subobject of an item in the *variable\_name\_list* has the **POINTER** attribute, the allocation and association status of the **POINTER** item is flushed, but the pointer target is not.

If an item in the *variable\_name\_list* is an integer pointer, the pointer is flushed, but the object to which it points is not.

If an item in the *variable\_name\_list* has the **ALLOCATABLE** attribute and the item is allocated, the allocated object is flushed; otherwise, the allocation status is flushed.

If an item in the *variable\_name\_list* is of type **C\_PTR**, the variable is flushed, but the storage that corresponds to that address is not flushed.

If you do not specify a *variable\_name\_list*, all thread visible variables are written to or read from memory.

When a thread encounters the **FLUSH** directive, it writes into memory the modifications to the affected variables. The thread also reads the latest copies of the variables from memory if it has local copies of those variables: for example, if it has copies of the variables in registers.

It is not mandatory for all threads in a team to use the **FLUSH** directive. However, to guarantee that all thread visible variables are current, any thread that modifies a thread visible variable should use the **FLUSH** directive to update the value of that variable in memory. If you do not use **FLUSH** or one of the directives that implies **FLUSH** (see below), the value of the variable might not be the most recent one.

The **FLUSH** directive does not imply any ordering between the directive and operations on variables not in the *variable\_name\_list*. The **FLUSH** directive does not imply any ordering between two or more **FLUSH** constructs if the constructs do not have any variables in common in the *variable\_name\_list*.

Note that **FLUSH** is not atomic. You must **FLUSH** shared variables that are controlled by a shared lock variable with one directive and then **FLUSH** the lock variable with another. This guarantees that the shared variables are written before the lock variable.

The following directives imply a **FLUSH** directive without the *variable\_name\_list* unless you specify a **NOWAIT** clause for those directives to which it applies:

- **BARRIER**
- **CRITICAL/END CRITICAL**
- **END DO**
- **END SECTIONS**
- **END SINGLE**
- **END WORKSHARE**
- **PARALLEL/END PARALLEL**
- **PARALLEL DO/END PARALLEL DO**
- **PARALLEL SECTIONS/END PARALLEL SECTIONS**

- **PARALLEL WORKSHARE/END PARALLEL WORKSHARE**
- **ORDERED/END ORDERED**

The **ATOMIC** directive implies a **FLUSH** directive with the *variable\_name\_list*. The *variable\_name\_list* contains only the object updated in the **ATOMIC** construct

The following routines imply a **FLUSH** directive without the *variable\_name\_list*:

- During **OMP\_SET\_LOCK**, and **OMP\_UNSET\_LOCK** regions.
- During **OMP\_TEST\_LOCK**, **OMP\_SET\_NEST\_LOCK**, **OMP\_UNSET\_NEST\_LOCK** and **OMP\_TEST\_NEST\_LOCK** regions, if the region causes the lock to be set or unset.

## Examples

In the following example, two threads perform calculations in parallel and are synchronized when the calculations are complete:

```

PROGRAM P
USE OMP_LIB
INTEGER INSYNC(0:1), IAM

!$OMP PARALLEL DEFAULT(PRIVATE) SHARED(INSYNC) NUM_THREADS(2)"
  IAM = OMP_GET_THREAD_NUM()
  INSYNC(IAM) = 0
!$OMP BARRIER
  CALL WORK
!$OMP FLUSH(INSYNC)
  INSYNC(IAM) = 1
!$OMP FLUSH(INSYNC)
  DO WHILE (INSYNC(1-IAM) .eq. 0)
!$OMP FLUSH(INSYNC)
  END DO
!$OMP END PARALLEL

END PROGRAM P

SUBROUTINE WORK
!
  ...
!$OMP FLUSH
END SUBROUTINE WORK

```

! Each thread sets a flag  
! once it has  
! completed its work.  
! One thread waits for  
! another to complete  
! its work.

! Each thread does indep-  
! endent calculations.

! flush work variables  
! before INSYNC  
! is flushed.

## MASTER / END MASTER

### Purpose

The **MASTER** construct enables you to define a block of code that will be run by only the master thread of the team. It includes a **MASTER** directive that precedes a block of code and ends with an **END MASTER** directive.

The **MASTER** and **END MASTER** directives only take effect if you specify the **-qsmp** compiler option.

## Syntax

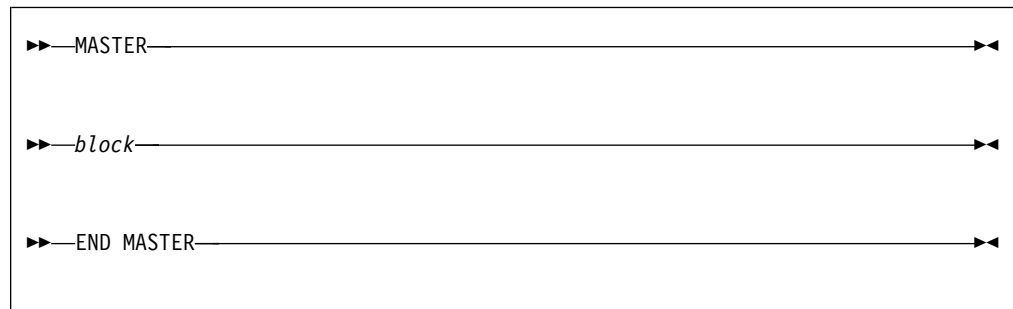

*block* represents the block of code that will be run by the master thread of the team.

## Rules

It is illegal to branch into or out of a **MASTER** construct.

A **MASTER** directive binds to the closest enclosing **PARALLEL** region, if one exists.

A **MASTER** directive cannot appear within a work-sharing region or a **TASK** region.

No implied barrier exists on entry to, or exit from, the **MASTER** construct.

## Examples

**Example 1:** An example of the **MASTER** directive binding to the **PARALLEL** directive.

```
!$OMP PARALLEL DEFAULT(SHARED)
!$OMP MASTER
    Y = 10.0
    X = 0.0
    DO I = 1, 4
        X = X + COS(Y) + I
    END DO
!$OMP END MASTER
!$OMP BARRIER
!$OMP DO PRIVATE(J)
    DO J = 1, 10000
        A(J) = X + SIN(J*2.5)
    END DO
!$OMP END DO
!$OMP END PARALLEL
END
```

**Related reference:**



See `-qsmp` in the Compiler Reference  
“**PARALLEL** / **END PARALLEL**” on page 126  
“**DO** / **END DO**” on page 116

## ORDERED / END ORDERED

### Purpose

The **ORDERED / END ORDERED** directives cause the iterations of a block of code within a parallel loop to be executed in the order that the loop would execute in if it was run sequentially. You can force the code inside the **ORDERED** construct to run in a predictable order while code outside of the construct runs in parallel.

The **ORDERED** and **END ORDERED** directives only take effect if you specify the **-qsmp** compiler option.

### Syntax



*block* represents the block of code that will be executed in sequence.

### Rules

The **ORDERED** directive can only appear in the dynamic extent of a **DO** or **PARALLEL DO** directive. It is illegal to branch into or out of an **ORDERED** construct.

The **ORDERED** directive binds to the nearest dynamically enclosing **DO** or **PARALLEL DO** directive. You must specify the **ORDERED** clause on the **DO** or **PARALLEL DO** directive to which the **ORDERED** construct binds.

**ORDERED** constructs that bind to different **DO** directives are independent of each other.

Only one thread can execute an **ORDERED** construct at a time. Threads enter the **ORDERED** construct in the order of the loop iterations. A thread will enter the **ORDERED** construct if all of the previous iterations have either executed the construct or will never execute the construct.

Each iteration of a parallel loop with an **ORDERED** construct can only execute that **ORDERED** construct once. Each iteration of a parallel loop can execute at most one **ORDERED** directive. An **ORDERED** construct cannot appear within the dynamic extent of a **CRITICAL** construct.

The **END ORDERED** directive implies the **FLUSH** directive without the *variable\_name\_list*

## Examples

**Example 1:** In this example, an **ORDERED** parallel loop counts down.

```
PROGRAM P
!$OMP PARALLEL DO ORDERED
DO I = 3, 1, -1
!$OMP ORDERED
CALL C_PRINT(I) ! print I using routine written in C
!$OMP END ORDERED
END DO
END PROGRAM P
```

The expected output of this program is:

```
3
2
1
```

**Example 2:** This example shows a program with two **ORDERED** constructs in a parallel loop. Each iteration can only execute a single section.

```
PROGRAM P
!$OMP PARALLEL DO ORDERED
DO I = 1, 3
IF (MOD(I,2) == 0) THEN
!$OMP ORDERED
CALL C_PRINT(I*10) ! print I*10 using routine written in C
!$OMP END ORDERED
ELSE
!$OMP ORDERED
CALL C_PRINT(I) ! print I using routine written in C
!$OMP END ORDERED
END IF
END DO
END PROGRAM P
```

The expected output of this program is:

```
1
20
3
```

**Example 3:** In this example, the program computes the sum of all elements of an array that are greater than a threshold. **ORDERED** is used to ensure that the results are always reproducible: roundoff will take place in the same order every time the program is executed, so the program will always produce the same results.

```
PROGRAM P
REAL :: A(1000)
REAL :: THRESHOLD = 999.9
REAL :: SUM = 0.0

!$OMP PARALLEL DO ORDERED
DO I = 1, 1000
IF (A(I) > THRESHOLD) THEN
!$OMP ORDERED
SUM = SUM + A(I)
!$OMP END ORDERED
END IF
END DO
END PROGRAM P
```

**Note:** To avoid bottleneck situations when using the **ORDERED** clause, you can try using **DYNAMIC** scheduling or **STATIC** scheduling with a small chunk size. For more information on scheduling parameters, see the “**SCHEDULE**” on page 179 clause.

**Related reference:**



See `-qsmp` in the Compiler Reference

“**PARALLEL DO / END PARALLEL DO**” on page 128

“**DO / END DO**” on page 116

“**CRITICAL / END CRITICAL**” on page 114

## PARALLEL / END PARALLEL

### Purpose

The **PARALLEL** construct enables you to define a block of code that can be executed by a team of threads concurrently. The **PARALLEL** construct includes a **PARALLEL** directive that is followed by one or more blocks of code, and ends with an **END PARALLEL** directive.

The **PARALLEL** and **END PARALLEL** directives only take effect if you specify the `-qsmp` compiler option.

### Syntax

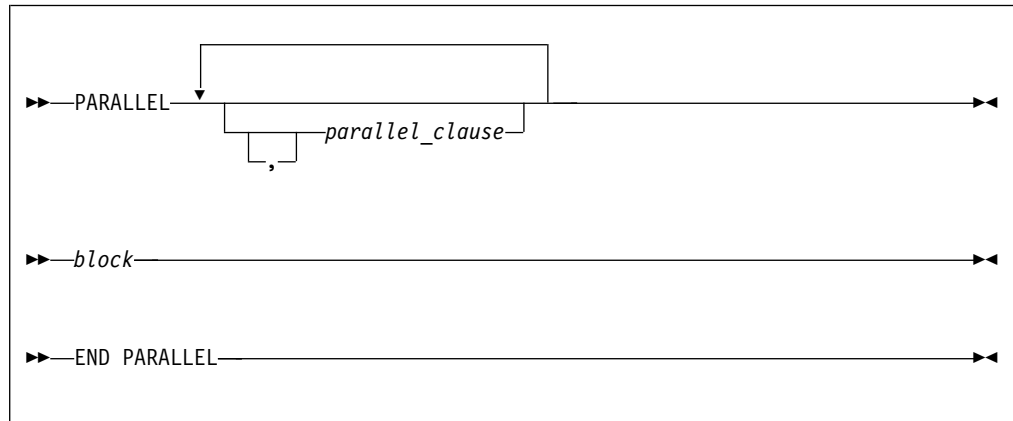

where *parallel\_clause* is:



#### *copyin* clause

See — “**COPYIN**” on page 163

#### *default* clause

See — “**DEFAULT**” on page 166

*if* **clause**

See — “IF” on page 169

*firstprivate* **clause**

See — “FIRSTPRIVATE” on page 168.

*num\_threads* **clause**

See — “NUM\_THREADS” on page 173.

*private* **clause**

See — “PRIVATE” on page 174.

*reduction* **clause**

See — “REDUCTION” on page 176

*shared* **clause**

See — “SHARED” on page 182

## Rules

It is illegal to branch into or out of a **PARALLEL** construct.

The **IF** and **DEFAULT** clauses can appear at most once in a **PARALLEL** directive.

You should be careful when you perform input/output operations in a parallel region. If multiple threads execute a Fortran I/O statement on the same unit, you should make sure that the threads are synchronized. If you do not, the behavior is undefined. See “Parallel I/O issues” on page 307 for more information. Also note that although in the XL Fortran implementation each thread has exclusive access to the I/O unit, the OpenMP specification does not require exclusive access.

Directives that bind to a parallel region will bind to that parallel region even if it is serialized.

The **END PARALLEL** directive implies the **FLUSH** directive without the *variable\_name\_list* and a **BARRIER** directive.

## Examples

**Example 1:** An example of an outer **PARALLEL** directive with the **PRIVATE** clause enclosing the **PARALLEL** construct. Note: The **SHARED** clause is present on the inner **PARALLEL** construct.

```
!$OMP PARALLEL PRIVATE(X)
!$OMP DO
    DO I = 1, 10
        X(I) = I
!$OMP PARALLEL SHARED (X,Y)
!$OMP DO
    DO K = 1, 10
        Y(K,I) = K * X(I)
    END DO
!$OMP END DO
!$OMP END PARALLEL
    END DO
!$OMP END DO
!$OMP END PARALLEL
```

**Example 2:** This example demonstrates the use of the **COPYIN** clause. Each thread created by the **PARALLEL** directive has its own copy of the common block

**BLOCK.** The **COPYIN** clause causes the initial value of *FCTR* to be copied into the threads that execute iterations of the **DO** loop.

```
PROGRAM TT
COMMON /BLOCK/ FCTR
INTEGER :: I, FCTR
!$OMP THREADPRIVATE(/BLOCK/)
INTEGER :: A(100)

FCTR = -1
A = 0

!$OMP PARALLEL COPYIN(FCTR)
!$OMP DO
DO I=1, 100
FCTR = FCTR + I
CALL SUB(A(I), I)
ENDDO
!$OMP END PARALLEL

PRINT *, A
END PROGRAM

SUBROUTINE SUB(AA, J)
INTEGER :: FCTR, AA, J
COMMON /BLOCK/ FCTR
!$OMP THREADPRIVATE(/BLOCK/) ! EACH THREAD GETS ITS OWN COPY
! OF BLOCK.

AA = FCTR
FCTR = FCTR - J
END SUBROUTINE SUB
```

The expected output is:

```
0 1 2 3 ... 96 97 98 99
```

**Related reference:**

“FLUSH” on page 120

“PARALLEL DO / END PARALLEL DO”

 See **INDEPENDENT** in the Language Reference

“THREADPRIVATE” on page 150

“DO / END DO” on page 116

 See **-qdirective** in the Compiler Reference

 See **-qsmp** in the Compiler Reference

## PARALLEL DO / END PARALLEL DO

### Purpose

The **PARALLEL DO** directive enables you to specify which loops the compiler should parallelize. This is semantically equivalent to:

```
!$OMP PARALLEL
!$OMP DO
...
!$OMP ENDDO
!$OMP END PARALLEL
```

and is a convenient way of parallelizing loops. The **END PARALLEL DO** directive allows you to indicate the end of a **DO** loop that is specified by the **PARALLEL DO** directive.



The **PARALLEL DO** and **END PARALLEL DO** directives only take effect if you specify the **-qsmp** compiler option.

## Syntax

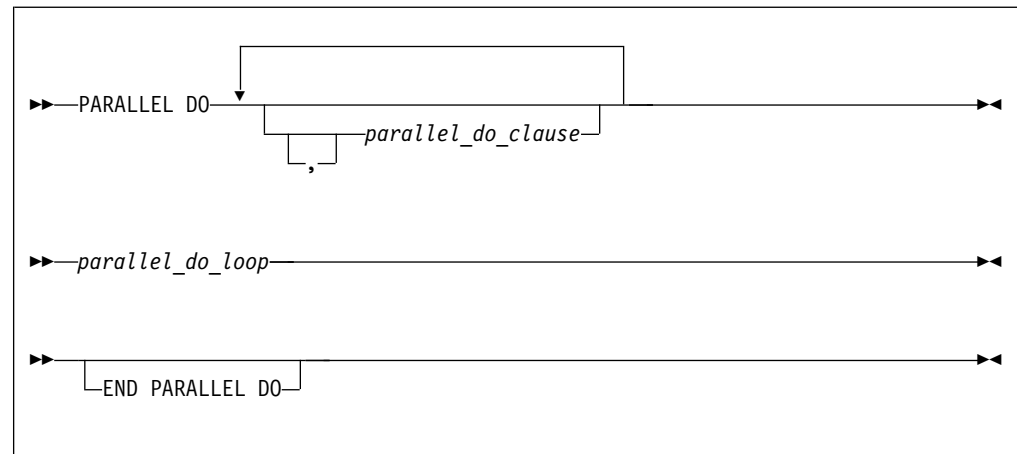

where *parallel\_do\_clause* is:

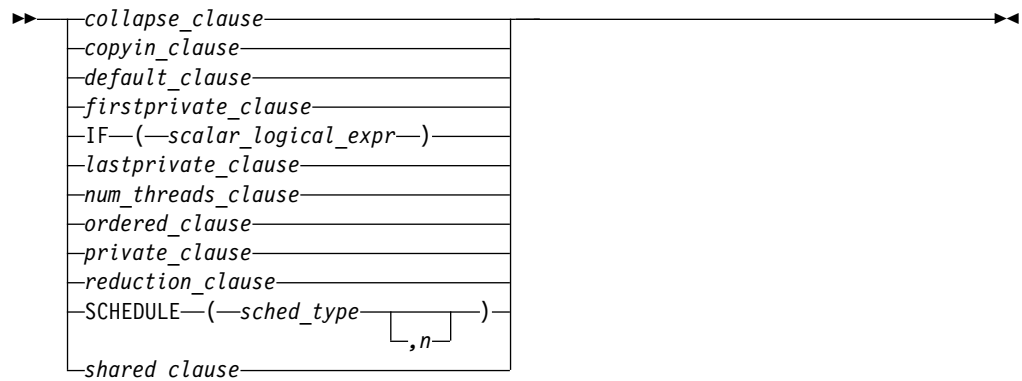

*collapse\_clause*

See — “COLLAPSE” on page 161

*copyin\_clause*

See — “COPYIN” on page 163

*default\_clause*

See — “DEFAULT” on page 166

*if\_clause*

See — “IF” on page 169.

*firstprivate\_clause*

See — “FIRSTPRIVATE” on page 168.

*lastprivate\_clause*

See — “LASTPRIVATE” on page 170.

*num\_threads\_clause*

See — “NUM\_THREADS” on page 173.

*ordered\_clause*

See — “ORDERED” on page 173

*private\_clause*  
See — “PRIVATE” on page 174

*reduction\_clause*  
See — “REDUCTION” on page 176

*schedule\_clause*  
See — “SCHEDULE” on page 179

*shared\_clause*  
See — “SHARED” on page 182

## Rules

The first noncomment line (not including other directives) that is following the **PARALLEL DO** directive must be a **DO** loop. This line cannot be an infinite **DO** or **DO WHILE** loop. The **PARALLEL DO** directive applies only to the **DO** loop that is immediately following the directive, and not to any nested **DO** loops, unless the **COLLAPSE** clause is specified.

If you specify a **DO** loop by a **PARALLEL DO** directive, the **END PARALLEL DO** directive is optional. If you use the **END PARALLEL DO** directive, it must immediately follow the end of the **DO** loop.

You may have a **DO** construct that contains several **DO** statements. If the **DO** statements share the same **DO** termination statement, and an **END PARALLEL DO** directive follows the construct, you can only specify a **PARALLEL DO** directive for the outermost **DO** statement of the construct.

You must not follow the **PARALLEL DO** directive by a **DO** (work-sharing) or **DO SERIAL** directive. You can specify only one **PARALLEL DO** directive for a given **DO** loop.

All work-sharing constructs and **BARRIER** directives that are encountered must be encountered in the same order by all threads in the team.

The **PARALLEL DO** directive must not appear with the **INDEPENDENT** directive for a given **DO** loop.

**Note:** You should use the **PARALLEL DO** directive for maximum portability across multiple vendors. The **PARALLEL DO** directive is a prescriptive directive, while the **INDEPENDENT** directive is an assertion about the characteristics of the loop. (See the **INDEPENDENT** directive in the *XL Fortran Language Reference* for more information.)

The **IF** clause may appear at most once in a **PARALLEL DO** directive.

An **IF** expression is evaluated outside of the context of the parallel construct. Any function reference in the **IF** expression must not have side effects.

By default, a nested parallel loop is serialized, regardless of the setting of the **IF** clause. You can change this default by using the **-qsmp=nested\_par** compiler option.

If the **REDUCTION** variable of an inner **DO** loop appears in the **PRIVATE** or **LASTPRIVATE** clause of an enclosing **DO** loop or **PARALLEL SECTIONS** construct, the variable must be initialized before the inner **DO** loop.

A variable that appears in the **REDUCTION** clause of an **INDEPENDENT** directive of an enclosing **DO** loop must not also appear in the *data\_scope\_entity\_list* of the **PRIVATE** or **LASTPRIVATE** clause.

Within a **PARALLEL DO** construct, variables that do not appear in the **PRIVATE** clause are assumed to be shared by default.

You should be careful when you perform input/output operations in a parallel region. If multiple threads execute a Fortran I/O statement on the same unit, you should make sure that the threads are synchronized. If you do not, the behavior is undefined. Also note that although in the XL Fortran implementation each thread has exclusive access to the I/O unit, the OpenMP specification does not require exclusive access.

Directives that bind to a parallel region will bind to that parallel region even if it is serialized.

The **END PARALLEL DO** directive implies the **FLUSH** directive without the *variable\_name\_list* and a **BARRIER** directive.

## Examples

**Example 1:** A valid example with the **LASTPRIVATE** clause.

```
!$OMP PARALLEL DO PRIVATE(I), LASTPRIVATE (X)
  DO I = 1,10
    X = I * I
    A(I) = X * B(I)
  END DO
PRINT *, X                                ! X has the value 100
```

**Example 2:** A valid example with the **REDUCTION** clause.

```
!$OMP PARALLEL DO PRIVATE(I), REDUCTION(+:MYSUM)
  DO I = 1, 10
    MYSUM = MYSUM + IARR(I)
  END DO
```

**Example 3:** A valid example where more than one thread accesses a variable that is marked as **SHARED**, but the variable is used only in a **CRITICAL** construct.

```
!$OMP PARALLEL DO SHARED (X)
  DO I = 1, 10
    A(I) = A(I) * I
  !$OMP CRITICAL
    X = X + A(I)
  !$OMP END CRITICAL
  END DO
```

**Example 4:** A valid example of the **END PARALLEL DO** directive.

```
REAL A(100), B(2:100), C(100)
!$OMP PARALLEL DO
  DO I = 2, 100
    B(I) = (A(I) + A(I-1))/2.0
  END DO
!$OMP END PARALLEL DO
!$OMP PARALLEL DO
  DO J = 1, 100
    C(J) = X + COS(J*5.5)
  END DO
!$OMP END PARALLEL DO
END
```

**Related reference:**

“COLLAPSE” on page 161



See `-qdirective` in the Compiler Reference



See `-qsmp` in the Compiler Reference



See `DO` in the Language Reference

“`DO / END DO`” on page 116



See `INDEPENDENT` in the Language Reference

“`ORDERED / END ORDERED`” on page 124

“`PARALLEL / END PARALLEL`” on page 126

“`PARALLEL SECTIONS / END PARALLEL SECTIONS`”

“`SCHEDULE`” on page 135

“`THREADPRIVATE`” on page 150

## PARALLEL SECTIONS / END PARALLEL SECTIONS

### Purpose

The `PARALLEL SECTIONS` construct provides a short form method for including `SECTIONS` directive inside a `PARALLEL` construct.

The `PARALLEL SECTIONS`, `SECTION` and `END PARALLEL SECTIONS` directives only take effect if you specify the `-qsmp` compiler option.

### Syntax

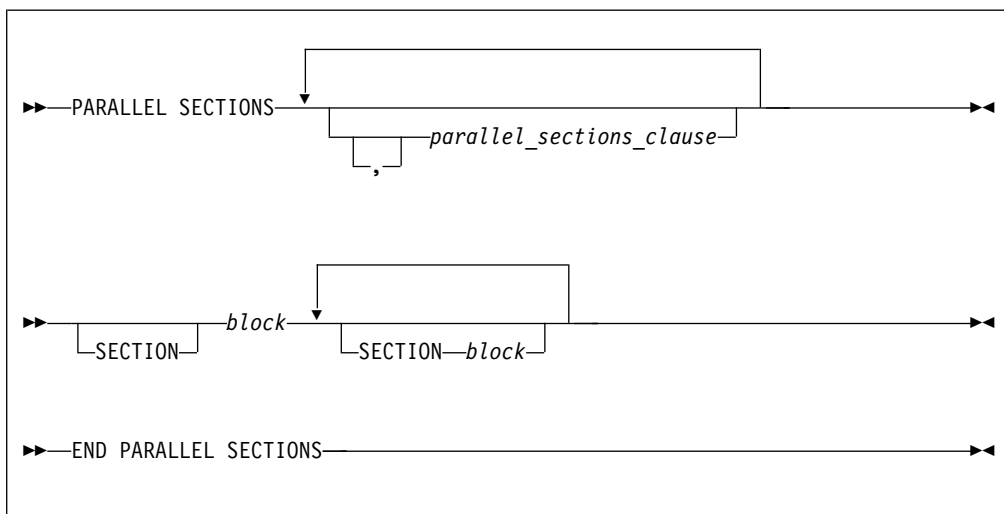

where *parallel\_sections\_clause* is:



***copyin* clause**

See — “COPYIN” on page 163

***default* clause**

See — “DEFAULT” on page 166

***firstprivate* clause**

See — “FIRSTPRIVATE” on page 168.

***if* clause**

See — “IF” on page 169

***lastprivate* clause**

See — “LASTPRIVATE” on page 170.

***num\_threads* clause**

See — “NUM\_THREADS” on page 173.

***private* clause**

See — “PRIVATE” on page 174.

***reduction* clause**

See — “REDUCTION” on page 176

***shared* clause**

See — “SHARED” on page 182

## Rules

See the Rules section in “SECTIONS / END SECTIONS” on page 138.

In a **PARALLEL SECTIONS** construct, a variable that appears in the **REDUCTION** clause of an **INDEPENDENT** directive or the **PARALLEL DO** directive of an enclosing **DO** loop must not also appear in the *data\_scope\_entity\_list* of the **PRIVATE** clause.

If the **REDUCTION** variable of the inner **PARALLEL SECTIONS** construct appears in the **PRIVATE** clause of an enclosing **DO** loop or **PARALLEL SECTIONS** construct, the variable must be initialized before the inner **PARALLEL SECTIONS** construct.

## Examples

**Example 1:**

```
!$OMP PARALLEL SECTIONS
!$OMP SECTION
  DO I = 1, 10
    C(I) = MAX(A(I),A(I+1))
  END DO
```

```

!$OMP SECTION
    W = U + V
    Z = X + Y
!$OMP END PARALLEL SECTIONS

```

**Example 2:** In this example, the index variable I is declared as **PRIVATE**. Note also that the first optional **SECTION** directive has been omitted.

```

!$OMP PARALLEL SECTIONS PRIVATE(I)
    DO I = 1, 100
        A(I) = A(I) * I
    END DO
!$OMP SECTION
    CALL NORMALIZE (B)
    DO I = 1, 100
        B(I) = B(I) + 1.0
    END DO
!$OMP SECTION
    DO I = 1, 100
        C(I) = C(I) * C(I)
    END DO
!$OMP END PARALLEL SECTIONS

```

**Related reference:**

“PARALLEL / END PARALLEL” on page 126

“SECTIONS / END SECTIONS” on page 138

 See INDEPENDENT in the Language Reference

 See -qdirective in the Compiler Reference

 See -qsmp in the Compiler Reference

## PARALLEL WORKSHARE / END PARALLEL WORKSHARE

### Purpose

The **PARALLEL WORKSHARE** construct provides a short form method for including a **WORKSHARE** directive inside a **PARALLEL** construct.

The **PARALLEL WORKSHARE / END PARALLEL WORKSHARE** directives only take effect if you specify the **-qsmp** compiler option

### Syntax

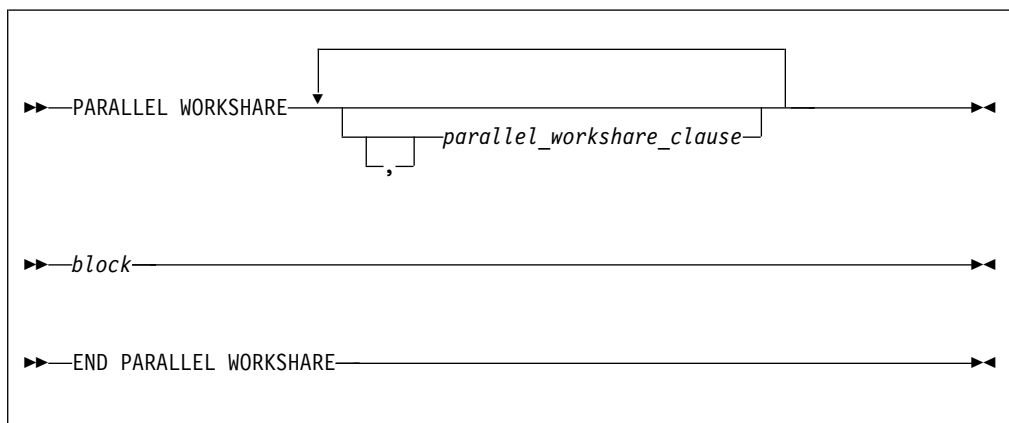

where *parallel\_workshare\_clause* is any of the directives accepted by either the **PARALLEL** or **WORKSHARE** directives.

**Related reference:**

“PARALLEL / END PARALLEL” on page 126

“WORKSHARE / END WORKSHARE” on page 156

## SCHEDULE

### Purpose

**Note:** The **SCHEDULE** directive has been deprecated and might be removed in a future release. Use the corresponding OpenMP SCHEDULE clause. For more information about the deprecated SMP directives and deprecation examples, see “Deprecated directive” on page 106.

The **SCHEDULE** directive allows the user to specify the chunking method for parallelization. Work is assigned to threads in different manners depending on the scheduling type or chunk size used.

The **SCHEDULE** directive only takes effect if you specify the **-qsmp** compiler option.

### Syntax

►► SCHEDULE—(*—sched\_type* , —*n*)

*n*            *n* must be a positive, specification expression. You must not specify *n* for the *sched\_type* **RUNTIME**.

*sched\_type*  
is **AFFINITY**, **DYNAMIC**, **GUIDED**, **RUNTIME**, or **STATIC**

For more information on *sched\_type* parameters, see the **SCHEDULE** clause.

*number\_of\_iterations*  
is the number of iterations in the loop to be parallelized.

*number\_of\_threads*  
is the number of threads used by the program.

### Rules

The **SCHEDULE** directive must appear in the specification part of a scoping unit.

Only one **SCHEDULE** directive may appear in the specification part of a scoping unit.

The **SCHEDULE** directive applies to the situation when all loops in the scoping unit do not already have explicit scheduling types specified. Individual loops can have scheduling types specified using the **SCHEDULE** clause of the **PARALLEL DO** directive.

Any dummy arguments appearing or referenced in the specification expression for the chunk size *n* must also appear in the **SUBROUTINE** or **FUNCTION** statement and in all **ENTRY** statements appearing in the given subprogram.

If the specified chunk size  $n$  is greater than the number of iterations, the loop will not be parallelized and will execute on a single thread.

If you specify more than one method of determining the chunking algorithm, the compiler will follow, in order of precedence:

1. **SCHEDULE** clause to the **PARALLEL DO** directive.
2. **SCHEDULE** directive.
3. **schedule** suboption to the **-qsmp** compiler option. See the **-qsmp** option in the *XL Fortran Compiler Reference*.
4. **XLSMPOPTS** runtime option. See “XLSMPOPTS” on page 90.
5. runtime default (that is, **STATIC**).

## Examples

**Example 1.** Given the following information:

```
number of iterations = 1000
number of threads = 4
```

and using the **GUIDED** scheduling type, the chunk sizes would be as follows:

```
250 188 141 106 79 59 45 33 25 19 14 11 8 6 4 3 3 2 1 1 1 1
```

The iterations would then be divided into the following chunks:

```
chunk 1 = iterations 1 to 250
chunk 2 = iterations 251 to 438
chunk 3 = iterations 439 to 579
chunk 4 = iterations 580 to 685
chunk 5 = iterations 686 to 764
chunk 6 = iterations 765 to 823
chunk 7 = iterations 824 to 868
chunk 8 = iterations 869 to 901
chunk 9 = iterations 902 to 926
chunk 10 = iterations 927 to 945
chunk 11 = iterations 946 to 959
chunk 12 = iterations 960 to 970
chunk 13 = iterations 971 to 978
chunk 14 = iterations 979 to 984
chunk 15 = iterations 985 to 988
chunk 16 = iterations 989 to 991
chunk 17 = iterations 992 to 994
chunk 18 = iterations 995 to 996
chunk 19 = iterations 997 to 997
chunk 20 = iterations 998 to 998
chunk 21 = iterations 999 to 999
chunk 22 = iterations 1000 to 1000
```

A possible scenario for the division of work could be:

```
thread 1 executes chunks 1 5 10 13 18 20
thread 2 executes chunks 2 7 9 14 16 22
thread 3 executes chunks 3 6 12 15 19
thread 4 executes chunks 4 8 11 17 21
```

**Example 2.** Given the following information:

```
number of iterations = 100
number of threads = 4
```

and using the **AFFINITY** scheduling type, the iterations would be divided into the following partitions:



```
partition 1 = iterations 1 to 25
partition 2 = iterations 26 to 50
partition 3 = iterations 51 to 75
partition 4 = iterations 76 to 100
```

The partitions would be divided into the following chunks:

```
chunk 1a = iterations 1 to 13
chunk 1b = iterations 14 to 19
chunk 1c = iterations 20 to 22
chunk 1d = iterations 23 to 24
chunk 1e = iterations 25 to 25
```

```
chunk 2a = iterations 26 to 38
chunk 2b = iterations 39 to 44
chunk 2c = iterations 45 to 47
chunk 2d = iterations 48 to 49
chunk 2e = iterations 50 to 50
```

```
chunk 3a = iterations 51 to 63
chunk 3b = iterations 64 to 69
chunk 3c = iterations 70 to 72
chunk 3d = iterations 73 to 74
chunk 3e = iterations 75 to 75
```

```
chunk 4a = iterations 76 to 88
chunk 4b = iterations 89 to 94
chunk 4c = iterations 95 to 97
chunk 4d = iterations 98 to 99
chunk 4e = iterations 100 to 100
```

A possible scenario for the division of work could be:

```
thread 1 executes chunks 1a 1b 1c 1d 1e 4d
thread 2 executes chunks 2a 2b 2c 2d
thread 3 executes chunks 3a 3b 3c 3d 3e 2e
thread 4 executes chunks 4a 4b 4c 4e
```

In this scenario, thread 1 finished executing all the chunks in its partition and then grabbed an available chunk from the partition of thread 4. Similarly, thread 3 finished executing all the chunks in its partition and then grabbed an available chunk from the partition of thread 2.

**Example 3.** Given the following information:

```
number of iterations = 1000
number of threads = 4
```

and using the **DYNAMIC** scheduling type and chunk size of 100, the chunk sizes would be as follows:

```
100 100 100 100 100 100 100 100 100 100
```

The iterations would be divided into the following chunks:

```
chunk 1 = iterations 1 to 100
chunk 2 = iterations 101 to 200
chunk 3 = iterations 201 to 300
chunk 4 = iterations 301 to 400
chunk 5 = iterations 401 to 500
chunk 6 = iterations 501 to 600
chunk 7 = iterations 601 to 700
chunk 8 = iterations 701 to 800
chunk 9 = iterations 801 to 900
chunk 10 = iterations 901 to 1000
```

A possible scenario for the division of work could be:

```

thread 1 executes chunks 1 5 9
thread 2 executes chunks 2 8
thread 3 executes chunks 3 6 10
thread 4 executes chunks 4 7

```

**Example 4.** Given the following information:

```

number of iterations = 100
number of threads = 4

```

and using the **STATIC** scheduling type, the iterations would be divided into the following chunks:

```

chunk 1 = iterations 1 to 25
chunk 2 = iterations 26 to 50
chunk 3 = iterations 51 to 75
chunk 4 = iterations 76 to 100

```

A possible scenario for the division of work could be:

```

thread 1 executes chunks 1
thread 2 executes chunks 2
thread 3 executes chunks 3
thread 4 executes chunks 4

```

**Related reference:**



See DO in the Language Reference

## SECTIONS / END SECTIONS

### Purpose

The **SECTIONS** construct defines distinct blocks of code to be executed in parallel by threads in the team.

The **SECTIONS** and **END SECTIONS** directives only take effect if you specify the **-qsmp** compiler option.

### Syntax

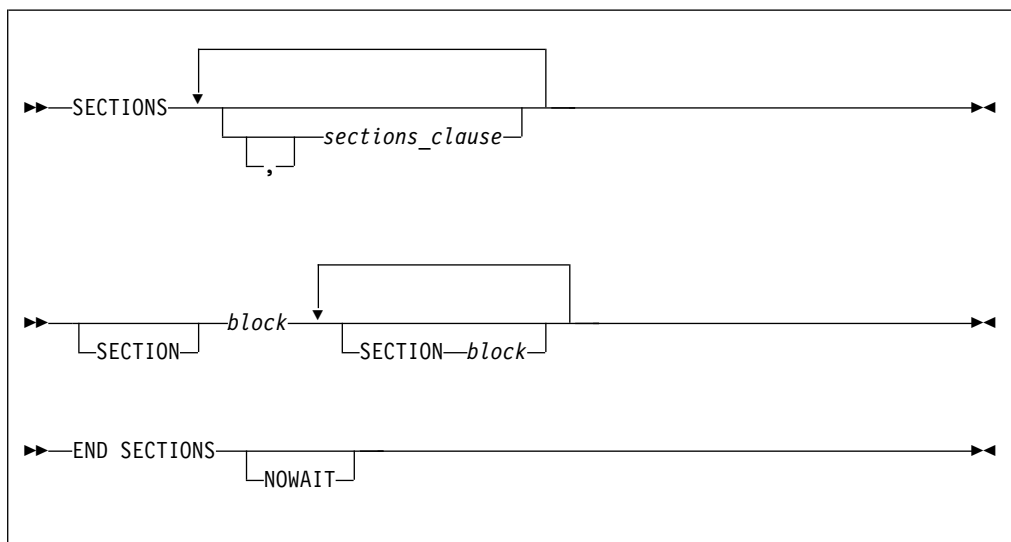

where *sections\_clause* is:

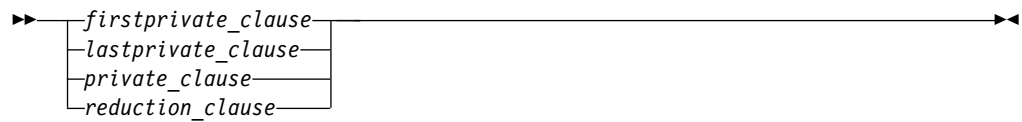

*firstprivate\_clause*

See — “FIRSTPRIVATE” on page 168.

*lastprivate\_clause*

See — “LASTPRIVATE” on page 170.

*private\_clause*

See — “PRIVATE” on page 174.

*reduction\_clause*

See — “REDUCTION” on page 176

## Rules

The **SECTIONS** construct must be encountered by all threads in a team or by none of the threads in a team. All work-sharing constructs and **BARRIER** directives that are encountered must be encountered in the same order by all threads in the team.

The **SECTIONS** construct includes the delimiting directives, and the blocks of code they enclose. At least one block of code must appear in the construct.

You must specify the **SECTION** directive at the beginning of each block of code except for the first. The end of a block is delimited by either another **SECTION** directive or by the **END SECTIONS** directive.

It is illegal to branch into or out of any block of code that is enclosed in the **SECTIONS** construct. All **SECTION** directives must appear within the lexical extent of the **SECTIONS/END SECTIONS** directive pair.

The scheduling of structured blocks among threads in the team is set so that the first thread arriving is the first thread to execute the block. The compiler determines how to divide the work among the threads based on a number of factors, such as the number of threads in the team and the number of sections to be executed in parallel. In a **SECTIONS** construct, a single thread might execute more than one **SECTION**. It is also possible that a thread in the team might not execute any **SECTION**.

In order for the directive to execute in parallel, you must place the **SECTIONS/END SECTIONS** pair within a parallel region. Otherwise, the blocks will be executed serially.

If you specify **NOWAIT** on the **SECTIONS** directive, a thread that completes its sections early will proceed to the instructions following the **SECTIONS** construct. If you do not specify the **NOWAIT** clause, each thread will wait for all of the other threads in the same team to reach the **END SECTIONS** directive. However, there is no implied **BARRIER** at the start of the **SECTIONS** construct.

You cannot specify a **SECTIONS** directive within the dynamic extent of a **CRITICAL**, **MASTER**, **ORDERED**, or **TASK** directive.

You cannot nest **SECTIONS**, **DO** or **SINGLE** directives that bind to the same **PARALLEL** directive.

**BARRIER** and **MASTER** directives are not permitted in the dynamic extent of a **SECTIONS** directive.

The **END SECTIONS** directive implies the **FLUSH** directive.

## Examples

**Example 1:** This example shows a valid use of the **SECTIONS** construct within a **PARALLEL** region.

```

      INTEGER :: I, B(500), S, SUM
! ...
      S = 0
      SUM = 0
!$OMP PARALLEL SHARED(SUM), FIRSTPRIVATE(S)
!$OMP SECTIONS REDUCTION(+: SUM), LASTPRIVATE(I)
!$OMP SECTION
      S = FCT1(B(1::2)) ! Array B is not altered in FCT1.
      SUM = SUM + S
! ...
!$OMP SECTION
      S = FCT2(B(2::2)) ! Array B is not altered in FCT2.
      SUM = SUM + S
! ...
!$OMP SECTION
      DO I = 1, 500      ! The local copy of S is initialized
        S = S + B(I)    ! to zero.
      END DO
      SUM = SUM + S
! ...
!$OMP END SECTIONS
! ...
!$OMP DO REDUCTION(-: SUM)
      DO J=I-1, 1, -1  ! The loop starts at 500 -- the last
                    ! value from the previous loop.
        SUM = SUM - B(J)
      END DO
!$OMP MASTER
      SUM = SUM - FCT1(B(1::2)) - FCT2(B(2::2))
!$OMP END MASTER
!$OMP END PARALLEL
! ...
                                ! Upon termination of the PARALLEL
                                ! region, the value of SUM remains zero.

```

**Example 2:** This example shows a valid use of nested **SECTIONS**.

```

!$OMP PARALLEL
!$OMP MASTER
      CALL RANDOM_NUMBER(CX)
      CALL RANDOM_NUMBER(CY)
      CALL RANDOM_NUMBER(CZ)
!$OMP END MASTER

!$OMP SECTIONS
!$OMP SECTION
!$OMP PARALLEL
!$OMP SECTIONS PRIVATE(I)
!$OMP SECTION
      DO I=1, 5000
        X(I) = X(I) + CX
      END DO
!$OMP SECTION
      DO I=1, 5000
        Y(I) = Y(I) + CY

```

```

        END DO
!$OMP  END SECTIONS
!$OMP  END PARALLEL

!$OMP SECTION
!$OMP  PARALLEL SHARED(CZ,Z)
!$OMP  DO
        DO I=1, 5000
            Z(I) = Z(I) + CZ
        END DO
!$OMP  END DO
!$OMP  END PARALLEL
!$OMP END SECTIONS NOWAIT

```

! The following computations do not  
! depend on the results from the  
! previous section.

```

!$OMP DO
        DO I=1, 5000
            T(I) = T(I) * CT
        END DO
!$OMP END DO
!$OMP END PARALLEL

```

**Related reference:**

“PARALLEL / END PARALLEL” on page 126

“BARRIER” on page 113

“PARALLEL DO / END PARALLEL DO” on page 128



See INDEPENDENT in the Language Reference

“THREADPRIVATE” on page 150



See -qdirective in the Compiler Reference



See -qsmp in the Compiler Reference

## SINGLE / END SINGLE

### Purpose

You can use the **SINGLE / END SINGLE** directive construct to specify that the enclosed code should only be executed by one thread in the team.

The **SINGLE** directive only takes effect if you specify the **-qsmp** compiler option.

### Syntax

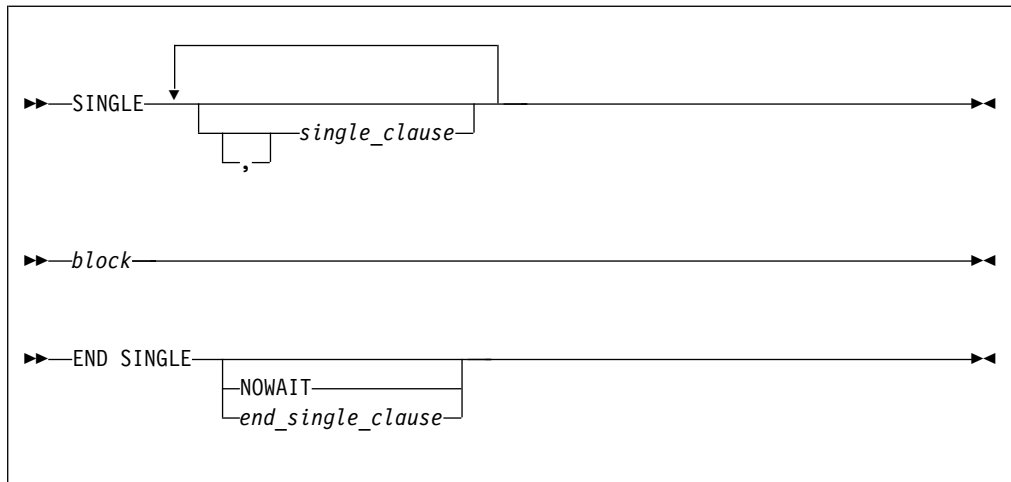

where *single\_clause* is:

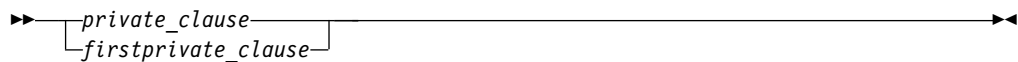

*private\_clause*

See — “PRIVATE” on page 174.

*firstprivate\_clause*

See — “FIRSTPRIVATE” on page 168.

where *end\_single\_clause* is:



## NOWAIT

*copyprivate\_clause*

See — “COPYPRIVATE” on page 165.

## Rules

It is illegal to branch into or out of a block that is enclosed within the **SINGLE** construct.

The **SINGLE** construct must be encountered by all threads in a team or by none of the threads in a team. The first thread to encounter the **SINGLE** construct will execute it. All work-sharing constructs and **BARRIER** directives that are encountered must be encountered in the same order by all threads in the team.

If you specify **NOWAIT** on the **END SINGLE** directive, the threads that are not executing the **SINGLE** construct will proceed to the instructions following the **SINGLE** construct. If you do not specify the **NOWAIT** clause, each thread will wait at the **END SINGLE** directive until the thread executing the construct reaches the **END SINGLE** directive. You may not specify **NOWAIT** and **COPYPRIVATE** as part of the same **END SINGLE** directive.

There is no implied **BARRIER** at the start of the **SINGLE** construct. If you do not specify the **NOWAIT** clause, the **BARRIER** directive is implied at the **END SINGLE** directive.

You cannot nest work-sharing constructs inside one another if they bind to the same **PARALLEL** directive.

**SINGLE** directives are not permitted within the **CRITICAL**, **MASTER**, **ORDERED**, or **TASK** regions. **BARRIER** and **MASTER** directives are not permitted within the **SINGLE** regions.

If you have specified a variable as **PRIVATE**, **FIRSTPRIVATE**, **LASTPRIVATE**, or **REDUCTION** in the **PARALLEL** construct which encloses your **SINGLE** construct, you cannot specify the same variable in the **PRIVATE** or **FIRSTPRIVATE** clause of the **SINGLE** construct.

The **SINGLE** directive binds to the closest enclosing **PARALLEL** region, if one exists.

## Examples

**Example 1:** In this example, the **BARRIER** directive is used to ensure that all threads finish their work before entering the **SINGLE** construct.

```
      REAL :: X(100), Y(50)
!
! ...
!$OMP PARALLEL DEFAULT(SHARED)
      CALL WORK(X)

!$OMP BARRIER
!$OMP SINGLE
      CALL OUTPUT(X)
      CALL INPUT(Y)
!$OMP END SINGLE

      CALL WORK(Y)
!$OMP END PARALLEL
```

**Example 2:** In this example, the **SINGLE** construct ensures that only one thread is executing a block of code. In this case, array *B* is initialized in the **DO** (work-sharing) construct. After the initialization, a single thread is employed to perform the summation.

```
      INTEGER :: I, J
      REAL :: B(500,500), SM
!
! ...

      J = ...
      SM = 0.0
!$OMP PARALLEL
!$OMP DO PRIVATE(I)
      DO I=1, 500
          CALL INITARR(B(I,:), I)      ! initialize the array B
      ENDDO
!$OMP END DO

!$OMP SINGLE                          ! employ only one thread
      DO I=1, 500
          SM = SM + SUM(B(J:J+1,I))
      ENDDO
!$OMP END SINGLE

!$OMP DO PRIVATE(I)
```

```

        DO I=500, 1, -1
            CALL INITARR(B(I,:), 501-I)    ! re-initialize the array B
        ENDDO
!$OMP END PARALLEL

```

**Example 3:** This example shows a valid use of the **PRIVATE** clause. Array *X* is **PRIVATE** to the **SINGLE** construct. If you were to reference array *X* immediately following the construct, it would be undefined.

```

        REAL :: X(2000), A(1000), B(1000)

!$OMP PARALLEL
!
...
!$OMP SINGLE PRIVATE(X)
    CALL READ_IN_DATA(X)
    A = X(1::2)
    B = X(2::2)
!$OMP END SINGLE
!
...
!$OMP END PARALLEL

```

**Example 4:** In this example, the **LASTPRIVATE** variable *I* is used in allocating *TMP*, the **PRIVATE** variable in the **SINGLE** construct.

```

        SUBROUTINE ADD(A, UPPERBOUND)
            INTEGER :: A(UPPERBOUND), I, UPPERBOUND
            INTEGER, ALLOCATABLE :: TMP(:)
!
...
!$OMP PARALLEL
!$OMP DO LASTPRIVATE(I)
    DO I=1, UPPERBOUND
        A(I) = I + 1
    ENDDO
!$OMP END DO

!$OMP SINGLE FIRSTPRIVATE(I), PRIVATE(TMP)
    ALLOCATE(TMP(0:I-1))
    TMP = (/ (A(J),J=I,1,-1) /)
!
...
    DEALLOCATE(TMP)
!$OMP END SINGLE
!$OMP END PARALLEL
!
...
END SUBROUTINE ADD

```

**Example 5:** In this example, a value for the variable *I* is entered by the user. This value is then copied into the corresponding variable *I* for all other threads in the team using a **COPYPRIVATE** clause on an **END SINGLE** directive.

```

        INTEGER I
!$OMP PARALLEL PRIVATE (I)
!
...
!$OMP SINGLE
    READ (*, *) I
!$OMP END SINGLE COPYPRIVATE (I)    ! In all threads in the team, I
                                    ! is equal to the value
!
...                                    ! that you entered.
!$OMP END PARALLEL

```

**Example 6:** In this example, variable *J* with a **POINTER** attribute is specified in a **COPYPRIVATE** clause on an **END SINGLE** directive. The value of *J*, not the value of the object that it points to, is copied into the corresponding variable *J* for all other threads in the team. The object itself is shared among all the threads in the team.



```

        INTEGER, POINTER :: J
!$OMP PARALLEL PRIVATE (J)
! ...
!$OMP SINGLE
        ALLOCATE (J)
        READ (*, *) J
!$OMP END SINGLE COPYPRIVATE (J)
!$OMP ATOMIC
        J = J + OMP_GET_THREAD_NUM()
!$OMP BARRIER
!$OMP SINGLE
        WRITE (*, *) 'J = ', J    ! The result is the sum of all values added to
                                ! J. This result shows that the pointer object
                                ! is shared by all threads in the team.

        DEALLOCATE (J)
!$OMP END SINGLE
!$OMP END PARALLEL

```

**Related reference:**

- “BARRIER” on page 113
- “CRITICAL / END CRITICAL” on page 114
- “FLUSH” on page 120
- “MASTER / END MASTER” on page 122
- “PARALLEL / END PARALLEL” on page 126

## TASK / END TASK

### Purpose

The **TASK** directive instructs the compiler to run a block of code in parallel with the code outside the task region. The **TASK** directive can be useful for parallelizing irregular algorithms such as pointer chasing or recursive algorithms. The **TASK** directive takes effect only if you specify the **-qsmp** compiler option.

### Syntax

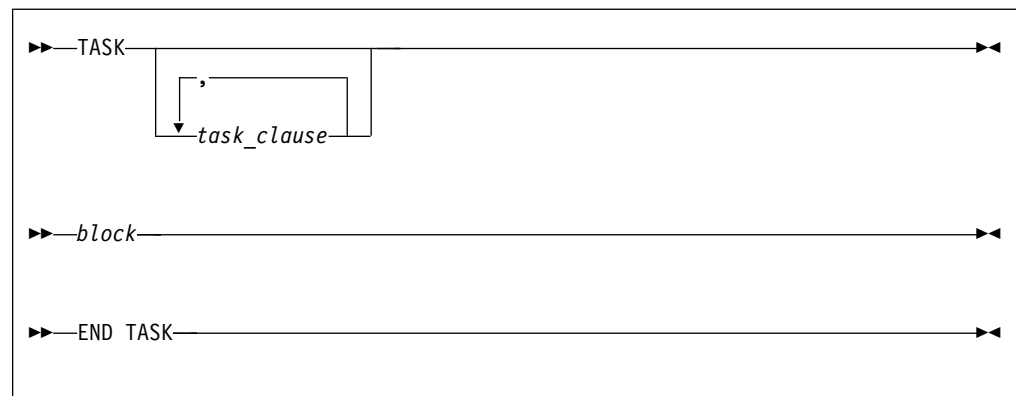

where *task\_clause* is:



*default\_clause*

See "DEFAULT" on page 166.

*final\_clause*

See "FINAL" on page 168.

*firstprivate\_clause*

See "FIRSTPRIVATE" on page 168.

*if\_clause*

See "IF" on page 169.

*mergeable\_clause*

See "MERGEABLE" on page 172.

*private\_clause*

See "PRIVATE" on page 174.

*shared\_clause*

See "SHARED" on page 182.

*untied\_clause*

See "UNTIED" on page 183.

## Rules

A final task is a task that makes all its child tasks become final and included tasks. A final task is generated when either of the following conditions is true:

- A **FINAL** clause is specified on a task construct and the **FINAL** clause expression evaluates to `.TRUE.`.
- The generated task is a child task of a final task.

An undeferred task is a task whose execution is not deferred with respect to its generating task region. In other words, the generating task region is suspended until the undeferred task has finished running. An undeferred task is generated when an **IF** clause is specified on a task construct and the **IF** clause expression evaluates to `.FALSE.`.

An included task is a task whose execution is sequentially included in the generating task region. In other words, an included task is undeferred and executed immediately by the encountering thread. An included task is generated when the generated task is a child task of a final task.

A merged task is a task that has the same data environment as that of its generating task region. A merged task might be generated when both the following conditions are true:

- A **MERGEABLE** clause is specified on a task construct.

- The generated task is an undeferred task or an included task.

The following rules are true if no **DEFAULT** clause is specified with the enclosing **TASK** construct:

- If the enclosing **TASK** construct is not lexically enclosed by a parallel region, dummy arguments that do not appear in any **PRIVATE**, **FIRSTPRIVATE**, **LASTPRIVATE**, or **SHARED** clause of the enclosing **TASK** construct are `firstprivate`.
- A variable that is private in the innermost enclosing parallel construct is `firstprivate` in the **TASK** construct.
- Local variables of a routine are `firstprivate` if there is no enclosing parallel construct.
- A variable that is determined to be shared in all of the enclosing constructs, up to and including the innermost enclosing parallel construct, is shared.

The **IF** clause expression and the **FINAL** clause expression are evaluated outside of the task construct, and the evaluation order is not specified.

**Related reference:**

- “FINAL” on page 168
- “FIRSTPRIVATE” on page 168
- “IF” on page 169
- “MERGEABLE” on page 172
- “DEFAULT” on page 166
- “PRIVATE” on page 174
- “SHARED” on page 182
- “TASKWAIT”
- “UNTIED” on page 183

## TASKWAIT

### Purpose

The **TASKWAIT** directive specifies a *wait* for child tasks to be completed that are generated by the current task.

### Syntax

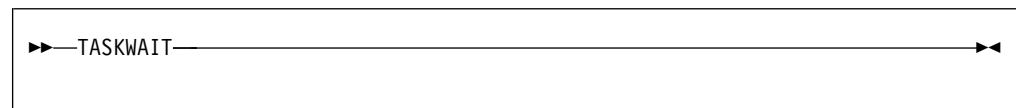

**Related reference:**

- “TASK / END TASK” on page 145

## TASKYIELD

### Purpose

The **TASKYIELD** directive instructs the compiler that it can suspend the current task in favor of running a different task. The **TASKYIELD** region includes an explicit task scheduling point in the current task region.

## Syntax

```
▶▶—TASKYIELD—▶▶
```

## THREADLOCAL

### Purpose

You can use the **THREADLOCAL** directive to declare thread-specific common data. It is a possible method of ensuring that access to data that is contained within **COMMON** blocks is serialized.

In order to make use of this directive it is not necessary to specify the **-qsmp** compiler option, but the invocation command must be **xlf\_r**, **xlf\_r7**, **xlf90\_r**, **xlf90\_r7**, **xlf95\_r**, **xlf95\_r7**, **xlf2003\_r**, or **xlf2008\_r** to link the necessary libraries.

### Syntax

```
▶▶—THREADLOCAL— [::] — /—common_block_name—/ ▶▶
```

### Rules

You can only declare named blocks as **THREADLOCAL**. All rules and constraints that normally apply to named common blocks apply to common blocks that are declared as **THREADLOCAL**. See the **COMMON** statement in the *XL Fortran Language Reference* for more information on the rules and constraints that apply to named common blocks.

The **THREADLOCAL** directive must appear in the *specification\_part* of the scoping unit. If a common block appears in a **THREADLOCAL** directive, it must also be declared within a **COMMON** statement in the same scoping unit. The **THREADLOCAL** directive may occur before or after the **COMMON** statement. See Main program in the *XL Fortran Language Reference* for more information on the *specification\_part* of the scoping unit.

A common block cannot be given the **THREADLOCAL** attribute if it is declared within a **PURE** subprogram.

Members of a **THREADLOCAL** common block must not appear in **NAMELIST** statements.

A common block that is use-associated must not be declared as **THREADLOCAL** in the scoping unit that contains the **USE** statement.

Any pointers declared in a **THREADLOCAL** common block are not affected by the **-qinit=f90ptr** compiler option.

Objects within **THREADLOCAL** common blocks may be used in parallel loops and parallel sections. However, these objects are implicitly shared across the iterations of the loop, and across code blocks within parallel sections. In other words, within a scoping unit, all accessible common blocks, whether declared as **THREADLOCAL** or not, have the **SHARED** attribute within parallel loops and sections in that scoping unit.

If a common block is declared as **THREADLOCAL** within a scoping unit, any subprogram that declares or references the common block, and that is directly or indirectly referenced by the scoping unit, must be executed by the same thread executing the scoping unit. If two procedures that declare common blocks are executed by different threads, then they would obtain different copies of the common block, provided that the common block had been declared **THREADLOCAL**. Threads can be created in one of the following ways:

- Explicitly, via *pthread*s library calls
- Implicitly by the compiler for parallel loop execution
- Implicitly by the compiler for parallel section execution.

If a common block is declared to be **THREADLOCAL** in one scoping unit, it must be declared to be **THREADLOCAL** in every scoping unit that declares the common block.

If a **THREADLOCAL** common block that does not have the **SAVE** attribute is declared within a subprogram, the members of the block become undefined at subprogram RETURN or END, unless there is at least one other scoping unit in which the common block is accessible that is making a direct or indirect reference to the subprogram.

You cannot specify the same *common\_block\_name* for both a **THREADLOCAL** directive and a **THREADPRIVATE** directive.

**Example 1:** The following procedure "FORT\_SUB" is invoked by two threads:

```

SUBROUTINE FORT_SUB(IARG)
  INTEGER IARG

  CALL LIBRARY_ROUTINE1()
  CALL LIBRARY_ROUTINE2()
  ...
END SUBROUTINE FORT_SUB
SUBROUTINE LIBRARY_ROUTINE1()
  COMMON /BLOCK/ R
  SAVE /BLOCK/
  !IBM* THREADLOCAL /BLOCK/
  R = 1.0
  ...
END SUBROUTINE LIBRARY_ROUTINE1
SUBROUTINE LIBRARY_ROUTINE2()
  COMMON /BLOCK/ R
  SAVE /BLOCK/
  !IBM* THREADLOCAL /BLOCK/

  ... = R
  ...
END SUBROUTINE LIBRARY_ROUTINE2

```

! The SAVE attribute is required for the  
! common block because the program requires  
! that the block remain defined after  
! library\_routine1 is invoked.

**Example 2:** "FORT\_SUB" is invoked by multiple threads. This is an invalid example because "FORT\_SUB" and "ANOTHER\_SUB" both declare /BLOCK/ to be THREADLOCAL. They intend to share the common block, but they are executed by different threads.

```

SUBROUTINE FORT_SUB()
  COMMON /BLOCK/ J
  INTEGER :: J
  !IBM* THREADLOCAL /BLOCK/           ! Each thread executing FORT_SUB
                                       ! obtains its own copy of /BLOCK/





  INTEGER A(10)

  ...
  !IBM* INDEPENDENT
  DO INDEX = 1,10
    CALL ANOTHER_SUB(A(I))
  END DO
  ...

END SUBROUTINE FORT_SUB
SUBROUTINE ANOTHER_SUB(AA)           ! Multiple threads are used to execute ANOTHER_SUB
  INTEGER AA
  COMMON /BLOCK/ J                   ! Each thread obtains a new copy of the
  INTEGER :: J                       ! common block /BLOCK/
  !IBM* THREADLOCAL /BLOCK/
  ...
  AA = J                             ! The value of 'J' is undefined.
END SUBROUTINE ANOTHER_SUB

```

**Related reference:**

-  See `-qdirective` in the Compiler Reference
-  See `-qinit` in the Compiler Reference
-  See `COMMON` in the Language Reference
-  See Main program in the Language Reference

## THREADPRIVATE

### Purpose

The **THREADPRIVATE** directive allows you to specify named common blocks and named variables as private to a thread but global within that thread. Once you declare a common block or variable **THREADPRIVATE**, each thread in the team maintains a separate copy of that common block or variable. Data written to a **THREADPRIVATE** common block or variable remains private to that thread and is not visible to other threads in the team.

In the serial and **MASTER** sections of a program, only the master thread's copy of the named common block and variable is accessible.

Use the **COPYIN** clause on the **PARALLEL**, **PARALLEL DO**, **PARALLEL SECTIONS** or **PARALLEL WORKSHARE** directives to specify that upon entry into a parallel region, data in the master thread's copy of a named common block or named variable is copied to each thread's private copy of that common block or variable.

The **THREADPRIVATE** directive only takes effect if you specify the **-qsmp** compiler option.

## Syntax

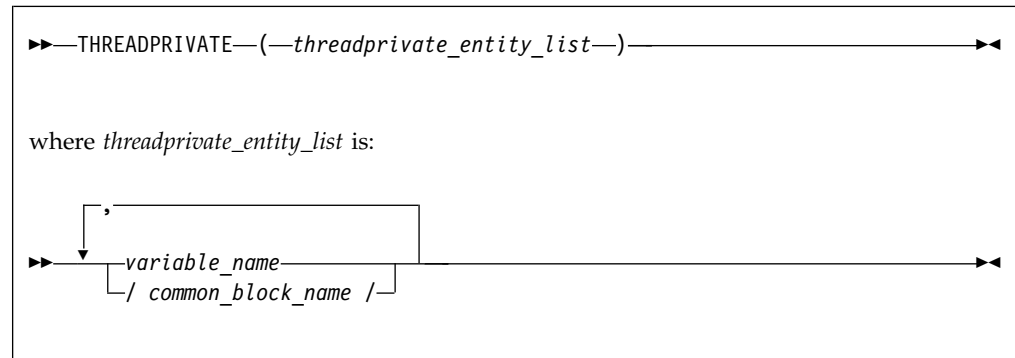

*common\_block\_name*

is the name of a common block to be made private to a thread.

*variable\_name*

is the name of a variable to be made private to a thread.

## Rules

You cannot specify a **THREADPRIVATE** variable, common block, or the variables that comprise that common block in a **PRIVATE**, **FIRSTPRIVATE**, **LASTPRIVATE**, **SHARED**, or **REDUCTION** clause.

A **THREADPRIVATE** variable must have the **SAVE** attribute. For variables or common blocks declared in the scope of a module, the **SAVE** attribute is implied. If you declare the variable outside of the scope of the module, the **SAVE** attribute must be specified.

In **THREADPRIVATE** directives, you can only specify named variables and named common blocks.

A variable can only appear in a **THREADPRIVATE** directive in the scope in which it is declared, and a **THREADPRIVATE** variable or common block may only appear once in a given scope. The variable must not be an element of a common block, or be declared in an **EQUIVALENCE** statement.

You cannot specify the same *common\_block\_name* for both a **THREADPRIVATE** directive and a **THREADLOCAL** directive.

All rules and constraints that apply to named common blocks also apply to common blocks declared as **THREADPRIVATE**. See the **COMMON** statement in the *XL Fortran Language Reference*.

If you declare a common block as **THREADPRIVATE** in one scoping unit, you must declare it as **THREADPRIVATE** in all other scoping units in which it is declared.

If you declare a **THREADPRIVATE** variable or a **THREADPRIVATE** common block with the **BIND** attribute, you must specify the corresponding C entities in a **THREADPRIVATE** directive in the C program. See Example 4 for the detailed usage information.

On entry into any parallel region, a **THREADPRIVATE** variable, or a variable in a **THREADPRIVATE** common block specified in a **COPYIN** clause is subject to the criteria stated in the **Rules** section for the **COPYIN** clause.

On entry into the first parallel region of the program, **THREADPRIVATE** variables or variables within a **THREADPRIVATE** common block not specified in a **COPYIN** clause are subject to the following criteria:

- If the variable has the **ALLOCATABLE** attribute, the initial allocation status of each copy of that variable is not currently allocated.
- If the variable has the **POINTER** attribute, and that pointer is disassociated through either explicit or default initialization, the association status of each copy of that variable is disassociated. Otherwise, the association status of the pointer is undefined.
- If the variable has neither the **ALLOCATABLE** nor the **POINTER** attribute and is defined through either explicit or default initialization, then each copy of that variable is defined. If the variable is undefined, then each copy of that variable is undefined.

On entry into subsequent parallel regions of the program, **THREADPRIVATE** variables, or variables within a **THREADPRIVATE** common block not specified in a **COPYIN** clause, are subject to the following criteria:

- If you are using the **OMP\_DYNAMIC** environment variable, or the **omp\_set\_dynamic** subroutine to enable dynamic threads and:
  - If the number of threads is smaller than the number of threads in the previous region, and if a **THREADPRIVATE** object is referenced in both regions, then threads with the same thread number in their respective regions will reference the same copy of that variable.
  - If the number of threads is larger than the number of threads in the previous region, then the definition and association status of a **THREADPRIVATE** object is undefined, and the allocation status is undefined.
- If dynamic threads are disabled, the definition, association, or allocation status and definition, if the thread's copy of the variable was defined, is retained.

You cannot access the name of a common block by use association or host association. Thus, a named common block can only appear on a **THREADPRIVATE** directive if the common block is declared in the scoping unit that contains the **THREADPRIVATE** directive. However, you can access the variables in the common block by use association or host association. For more information, see Host and Use association in the *XL Fortran Language Reference*.

The **-qinit=f90ptr** compiler option does not affect pointers that you have declared in a **THREADPRIVATE** common block.

The **DEFAULT** clause does not affect variables in **THREADPRIVATE** common blocks.

## Examples

**Example 1:** In this example, the **PARALLEL DO** directive invokes multiple threads that call **SUB1**. The common block **BLK** in **SUB1** shares the data that is specific to the thread with subroutine **SUB2**, which is called by **SUB1**.

```
PROGRAM TT
  INTEGER :: I, B(50)

!$OMP PARALLEL DO SCHEDULE(STATIC, 10)
```



```

        DO I=1, 50
            CALL SUB1(I, B(I))      ! Multiple threads call SUB1.
        ENDDO
    END PROGRAM TT

    SUBROUTINE SUB1(J, X)
        INTEGER :: J, X, A(100)
        COMMON /BLK/ A
    !$OMP THREADPRIVATE(/BLK/)    ! Array a is private to each thread.
    ! ...
        CALL SUB2(J)
        X = A(J) + A(J + 50)
    ! ...
    END SUBROUTINE SUB1

    SUBROUTINE SUB2(K)
        INTEGER :: C(100)
        COMMON /BLK/ C
    !$OMP THREADPRIVATE(/BLK/)
    ! ...
        C = K
    ! ...
        ! Since each thread has its own copy of
        ! common block BLK, the assignment of
        ! array C has no effect on the copies of
        ! that block owned by other threads.
    END SUBROUTINE SUB2

```

**Example 2:** In this example, each thread has its own copy of the common block **ARR** in the parallel section. If one thread initializes the common block variable **TEMP**, the initial value is not visible to other threads.

```

    PROGRAM ABC
        INTEGER :: I, TEMP(100), ARR1(50), ARR2(50)
        COMMON /ARR/ TEMP
    !$OMP THREADPRIVATE(/ARR/)
        INTERFACE
            SUBROUTINE SUBS(X)
                INTEGER :: X(:)
            END SUBROUTINE
        END INTERFACE
    ! ...
    !$OMP PARALLEL SECTIONS
    !$OMP SECTION
    ! ...
        TEMP(1:100:2) = -1
        TEMP(2:100:2) = 2
        CALL SUBS(ARR1)
    ! ...
    !$OMP SECTION
    ! ...
        TEMP(1:100:2) = 1
        TEMP(2:100:2) = -2
        CALL SUBS(ARR2)
    ! ...
    !$OMP END PARALLEL SECTIONS
    ! ...
        PRINT *, SUM(ARR1), SUM(ARR2)
    END PROGRAM ABC

    SUBROUTINE SUBS(X)
        INTEGER :: K, X(:), TEMP(100)
        COMMON /ARR/ TEMP
    !$OMP THREADPRIVATE(/ARR/)
    ! ...
        DO K = 1, UBOUND(X, 1)
            X(K) = TEMP(K) + TEMP(K + 1)
        ! The thread is accessing its
        ! own copy of

```

```

! the common block.
        ENDDO
! ...
        END SUBROUTINE SUBS

```

The expected output for this program is:

```
50 -50
```

**Example 3:** In the following example, local variables outside of a common block are declared as **THREADPRIVATE**.

```

        MODULE MDL
            INTEGER          :: A(2)
            INTEGER, POINTER :: P
            INTEGER, TARGET  :: T
!$OMP THREADPRIVATE(A, P)
        END MODULE MDL

        PROGRAM MVAR
        USE OMP_LIB
        USE MDL

        INTEGER :: I

        CALL OMP_SET_NUM_THREADS(2)
        A = (/1, 2/)
        T = 4
        P => T

!$OMP PARALLEL PRIVATE(I) COPYIN(A, P)
        I = OMP_GET_THREAD_NUM()
        IF (I .EQ. 0) THEN
            A(1) = 100
            T = 5
        ELSE IF (I .EQ. 1) THEN
            A(2) = 200
        END IF
!$OMP END PARALLEL

!$OMP PARALLEL PRIVATE(I)
        I = OMP_GET_THREAD_NUM()
        IF (I .EQ. 0) THEN
            PRINT *, 'A(2) = ', A(2)
        ELSE IF (I .EQ. 1) THEN
            PRINT *, 'A(1) = ', A(1)
            PRINT *, 'P => ', P
        END IF
!$OMP END PARALLEL

        END PROGRAM MVAR

```

If dynamic threads mechanism is disabled, the expected output is:

```

A(2) = 2
A(1) = 1
P => 5
or
A(1) = 1
P => 5
A(2) = 2

```

**Example 4:** In this example, the C interoperable variable **NUMVAR** is declared as **THREADPRIVATE**. Changes made by thread 1 to the private copy of **NUMVAR** does not affect the copy of the master thread.

### Fortran source file

```
MODULE M
  USE, INTRINSIC :: ISO_C_BINDING
  INTEGER(C_INT), BIND(C) :: NUMVAR(10)
!$OMP THREADPRIVATE(NUMVAR)
END MODULE M

PROGRAM P
  USE M
  USE OMP_LIB
  INTERFACE
    SUBROUTINE INIT_NUM() BIND(C)
    END SUBROUTINE INIT_NUM

    SUBROUTINE PRINT_NUM() BIND(C)
    END SUBROUTINE PRINT_NUM
  END INTERFACE
  INTEGER TNUM
  CALL INIT_NUM()

  CALL OMP_SET_NUM_THREADS(2)

!$OMP PARALLEL COPYIN(NUMVAR)
  TNUM = OMP_GET_THREAD_NUM()
  IF (TNUM .EQ. 0) THEN
    ! PROCESS NUMVAR
  ELSE IF (TNUM .EQ. 1) THEN
    NUMVAR = NUMVAR * 4
    CALL PRINT_NUM()
    ! PROCESS NUMVAR
  END IF
!$OMP END PARALLEL
  CALL PRINT_NUM()
END PROGRAM P
```

### C source file

```
#include <stdio.h>
extern int numvar[10];
#pragma omp threadprivate(numvar)

void init_num(){
  for (int i = 0; i < 10; ++ i)
    numvar[i] = i * i;
}

void print_num(){
  for (int i = 0; i < 10; ++ i)
    printf("%d ", numvar[i]);
  printf("\n");
}
```

The expected output for this program is:

```
0 4 16 36 64 100 144 196 256 324
0 1 4 9 16 25 36 49 64 81
```

### Related reference:



See COMMON in the Language Reference

“OMP\_DYNAMIC” on page 98

“omp\_set\_dynamic(enable\_expr)” on page 198

“PARALLEL / END PARALLEL” on page 126

“PARALLEL DO / END PARALLEL DO” on page 128

“PARALLEL SECTIONS / END PARALLEL SECTIONS” on page 132

# WORKSHARE / END WORKSHARE

## Purpose

The **WORKSHARE** directive allows you to parallelize the execution of array operations. A **WORKSHARE** directive divides the tasks associated with an enclosed block of code into *units of work*. When a team of threads encounters a **WORKSHARE** directive, the threads in the team share the tasks, so that each *unit of work* executes exactly once.

The **WORKSHARE** directive only takes effect if you specify the **-qsmp** compiler option.

## Syntax

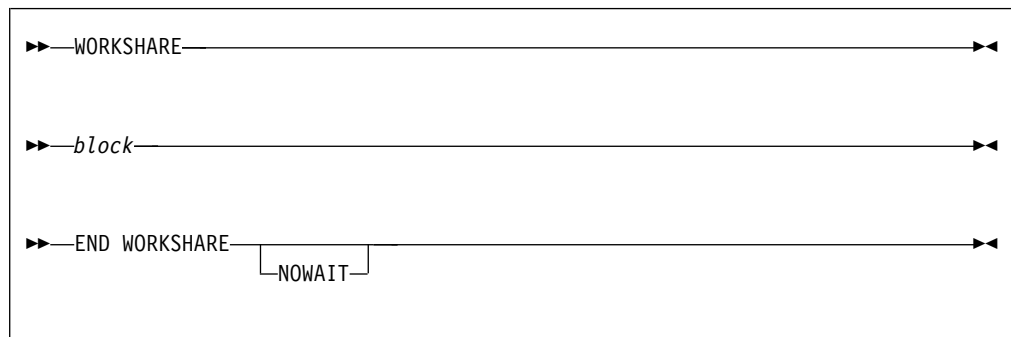

*block* is a structured block of statements that allows work sharing within the lexical extent of the **WORKSHARE** construct. The execution of statements are synchronized so that statements whose result is a dependent on another statement are evaluated before that result is required. The *block* can contain any of the following:

- Array assignment statements
- **ATOMIC** directives
- **CRITICAL** constructs
- **FORALL** constructs
- **FORALL** statements
- **PARALLEL** constructs
- **PARALLEL DO** constructs
- **PARALLEL SECTION** constructs
- **PARALLEL WORKSHARE** constructs
- Scalar assignment statements
- **WHERE** constructs
- **WHERE** statements

The transformational intrinsic functions you can use as part of an array operation are:

- |                      |                 |                    |
|----------------------|-----------------|--------------------|
| • <b>ALL</b>         | • <b>MATMUL</b> | • <b>PRODUCT</b>   |
| • <b>ANY</b>         | • <b>MAXLOC</b> | • <b>RESHAPE</b>   |
| • <b>COUNT</b>       | • <b>MAXVAL</b> | • <b>SPREAD</b>    |
| • <b>CSHIFT</b>      | • <b>MINLOC</b> | • <b>SUM</b>       |
| • <b>DOT_PRODUCT</b> | • <b>MINVAL</b> | • <b>TRANSPOSE</b> |
| • <b>EOSHIFT</b>     | • <b>PACK</b>   | • <b>UNPACK</b>    |

The *block* can also contain statements bound to lexically enclosed **PARALLEL** constructs. These statements are not restricted.

Any user-defined function calls within the *block* must be elemental.

Statements enclosed in a **WORKSHARE** directive are divided into *units of work*. The definition of a *unit of work* varies according to the statement evaluated. A *unit of work* is defined as follows:

- **Array expressions:** Evaluation of each element of an array expression is a *unit of work*. Any of the transformational intrinsic functions listed above may be divided into any number of *units of work*.
- **Assignment statements:** In an array assignment statement, the assignment of each element in the array is a *unit of work*. For scalar assignment statements, the assignment operation is a *unit of work*.
- **Constructs:** Evaluation of each **CRITICAL** construct is a *unit of work*. Each **PARALLEL** construct contained within a **WORKSHARE** construct is a single *unit of work*. New teams of threads execute the statements contained within the lexical extent of the enclosed **PARALLEL** constructs. In **FORALL** constructs or statements, the evaluation of the mask expression, expressions occurring in the specification of the iteration space, and the masked assignments are *units of work*. In **WHERE** constructs or statements, the evaluation of the mask expression and the masked assignments are *units of work*.
- **Directives:** The update of each scalar variable for an **ATOMIC** directive and its assignments is a *unit of work*.
- **ELEMENTAL functions:** If the argument to an **ELEMENTAL** function is an array, then the application of the function to each element of an array is a *unit of work*.

If none of the above definitions apply to a statement within the *block*, then that statement is a *unit of work*.

## Rules

In order to ensure that the statements within a **WORKSHARE** construct execute in parallel, the construct must be enclosed within a parallel region. Threads encountering a **WORKSHARE** construct outside the dynamic extent of a parallel region will evaluate the statements within the construct serially.

A **WORKSHARE** directive binds to the closest enclosing **PARALLEL** region if one exists.

You must not nest work-sharing regions that bind to the same **PARALLEL** region.

You must not specify a **WORKSHARE** directive within the **CRITICAL**, **MASTER**, or **ORDERED** regions.

You must not specify **BARRIER**, **MASTER**, or **ORDERED** directives within a **WORKSHARE** region.

If an array assignment, scalar assignment, a masked array assignment or a **FORALL** assignment assigns to a private variable in the *block*, the result is undefined.

If an array expression in the *block* references the value, association status or allocation status of private variables, the value of the expression is undefined unless each thread computes the same value.

If you do not specify a **NO WAIT** clause at the end of a **WORKSHARE** construct, a **BARRIER** directive is implied.

A **WORKSHARE** construct must be encountered by all threads in the team or by none at all.

## Examples

**Example 1:** In the following example, the **WORKSHARE** directive evaluates the masked expressions in parallel.

```
!$OMP WORKSHARE
  FORALL (I = 1 : N, AA(1, I) == 0) AA(1, I) = I
  BB = TRANSPOSE(AA)
  CC = MATMUL(AA, BB)
!$OMP ATOMIC
  S = S + SUM(CC)
!$OMP END WORKSHARE
```

**Example 2:** The following example includes a user defined **ELEMENTAL** as part of a **WORKSHARE** construct.

```
!$OMP WORKSHARE
  WHERE (AA(1, :) /= 0.0) AA(1, :) = 1 / AA(1, :)
  DD = TRANS(AA(1, :))
!$OMP END WORKSHARE

ELEMENTAL REAL FUNCTION TRANS(ELM) RESULT(RES)
REAL, INTENT(IN) :: ELM
RES = ELM * ELM + 4
END FUNCTION
```

### Related reference:

“ATOMIC” on page 107

“BARRIER” on page 113

“CRITICAL / END CRITICAL” on page 114

“PARALLEL WORKSHARE / END PARALLEL WORKSHARE” on page 134



See `-qsmp` in the Compiler Reference

---

## Data sharing attribute rules

The rules of data sharing attributes determine the attributes of variables that are referenced in **PARALLEL** and **TASK** directives, and work-sharing regions.

### Data sharing attribute rules for variables referenced in a construct

The data sharing attributes of variables that are referenced in a construct can be classified into the following categories:

- Predetermined data sharing attributes
- Explicitly determined data sharing attributes
- Implicitly determined data sharing attributes

Specifying a variable in a **FIRSTPRIVATE**, **LASTPRIVATE**, or **REDUCTION** clause of an enclosed construct initiates an implicit reference to the variable in the enclosing construct. Such implicit references also follow the data sharing attribute rules.

Some variables and objects have predetermined data sharing attributes as follows:

- Variables and common blocks specified in the **THREADPRIVATE** directive are **threadprivate**.
- The loop iteration variables in the associated **DO** loops of a **DO** or **PARALLEL DO** construct are private.
- Loop iteration variables for a sequential loop in a **PARALLEL** or **TASK** construct are private in the innermost such construct that encloses the loop.
- Implied-**DO** indices and **FORALL** indices are private.
- Integer pointees inherit the data sharing attributes of the storage with which their integer pointers are associated.
- Assumed-size arrays are shared.

Variables with predetermined data sharing attributes cannot be specified in data sharing attribute clauses. However, in the following situations, specifying a predetermined variable in a data sharing attribute clause is allowed and overrides the variable's predetermined data sharing attributes.

- The loop iteration variables in the associated **DO** loops of a **DO** or **PARALLEL DO** construct can be specified in a **PRIVATE** or **LASTPRIVATE** clause.
- Variables used as loop iteration variables in sequential loops within a **PARALLEL** or **TASK** construct can be specified in data sharing clauses on the construct itself, and on enclosed constructs, subject to other restrictions.
- Assumed-size arrays can be specified in a **SHARED** clause.

Variables that meet the following conditions have explicitly determined data sharing attributes:

- The variables are referenced in a construct.
- The variables are specified in a data sharing attribute clause on the construct.

Variables that meet all the following conditions have implicitly determined data sharing attributes:

- The variables are referenced in a construct.
- The variables do not have predetermined data sharing attributes.
- The variables are not specified in a data sharing attribute clause on the construct.

Rules for variables that have implicitly determined data sharing attributes are as follows:

- In a **PARALLEL** or **TASK** construct, the data sharing attributes of the variables are determined by the **DEFAULT** clause, if present.
- In a **PARALLEL** construct, if no **DEFAULT** clause is present, the variables are shared.
- For constructs other than **TASK**, if no **DEFAULT** clause is present, the variables inherit their data sharing attributes from the enclosing context.
- In a **TASK** construct, if no **DEFAULT** clause is present, a variable that is determined to be shared in the enclosing context by all implicit tasks bound to the current team is shared.

- In an orphaned **TASK** construct, if no **DEFAULT** clause is present, dummy arguments are **firstprivate**.
- In a **TASK** construct, if no **DEFAULT** clause is present, variables whose data sharing attributes are not determined by the rules above are **firstprivate**.

### **Data sharing attribute rules for variables referenced in a region but not in a construct**

The data sharing attributes of variables that are referenced in a region, but not in a construct, are determined as follows:

- For local variables declared in called routines in the region, if the variables have the **save** attribute or are data initialized, then they are shared unless they are specified in a **THREADPRIVATE** directive.
- Variables that belong to common blocks, or declared in modules, and referenced in called procedures in the region are shared unless they are specified in a **THREADPRIVATE** directive.
- Dummy arguments of called procedures in the region that are passed by reference inherit the data sharing attributes of the associated actual argument.
- Integer pointees inherit the data sharing attribute of the storage with which their integer pointers are associated.
- Implied-**DO** indices, **FORALL** indices, and other local variables declared in procedures in the region are private.

---

## **Directive clauses**

You can use directive clauses to specify additional information to directives.

### **Global rules for directive clauses**

You must not specify a variable or common block name more than once in a clause.

A variable, common block name, or variable name that is a member of a common block must not appear in more than one clause on the same directive, with the following exceptions:

- You can define a named common block or named variable as **FIRSTPRIVATE** and **LASTPRIVATE** for the same directive.
- A variable appearing in a **NUM\_THREADS** clause can appear in another clause for the same directive.
- A variable appearing in a **IF** clause can appear in another clause for the same directive.

If you do not specify a clause that changes the scope of a variable, the default scope for variables affected by a directive is **SHARED**.

A local variable with the **SAVE** or **STATIC** attribute declared in a procedure referenced a parallel region has an implicit **SHARED** attribute. A local variable without the **SAVE** or **STATIC** attribute declared in a procedure referenced a parallel region has an implicit **PRIVATE** attribute.

Members of common blocks and variables of modules declared in a procedure referenced within the dynamic extent of a parallel region have an implicit **SHARED** attribute, unless they are **THREADLOCAL** or **THREADPRIVATE** common blocks and module variables.



While a parallel or work-sharing construct is running, a variable or variable subobject used in a **PRIVATE**, **FIRSTPRIVATE**, **LASTPRIVATE** or **REDUCTION** clause of the directive must not be referenced, become defined, become undefined, have its association status or allocation status changed, or appear as an actual argument:

- In a scoping unit other than the one in which the directive construct appears
- In a variable format expression

You can declare a variable as **PRIVATE**, **FIRSTPRIVATE**, **LASTPRIVATE**, or **REDUCTION**, even if that variable is already storage associated with other variables. Storage association may exist for variables declared in **EQUIVALENCE** statements or in **COMMON** blocks. If a variable is storage associated with a **PRIVATE**, **FIRSTPRIVATE**, **LASTPRIVATE**, or **REDUCTION** variable, then:

- The contents, allocation status and association status of the variable that is storage associated with the **PRIVATE**, **FIRSTPRIVATE**, **LASTPRIVATE** or **REDUCTION** variable are undefined on entry to the parallel construct.
- The allocation status, association status and the contents of the associated variable become undefined if you define the **PRIVATE**, **FIRSTPRIVATE**, **LASTPRIVATE** or **REDUCTION** variable or if you define that variable's allocation or association status.
- The allocation status, association status and the contents of the **PRIVATE**, **FIRSTPRIVATE**, **LASTPRIVATE** or **REDUCTION** variable become undefined if you define the associated variable or if you define the associated variable's allocation or association status.

## Pointers and OpenMP API

OpenMP API allows a variable or variable subobject of a **PRIVATE** clause to have the **POINTER** or **ALLOCATABLE** attribute. The association status of the pointer is undefined at thread creation and when the thread is destroyed.

See the following topics for more information about the directive clauses:

|                    |                     |                  |
|--------------------|---------------------|------------------|
| <b>COLLAPSE</b>    | <b>FIRSTPRIVATE</b> | <b>PRIVATE</b>   |
| <b>COPYIN</b>      | <b>LASTPRIVATE</b>  | <b>REDUCTION</b> |
| <b>COPYPRIVATE</b> | <b>NUM_THREADS</b>  | <b>SCHEDULE</b>  |
| <b>DEFAULT</b>     | <b>ORDERED</b>      | <b>SHARED</b>    |
| <b>IF</b>          |                     | <b>UNTIED</b>    |

## COLLAPSE

### Purpose

Specifying the **COLLAPSE** clause allows you to parallelize multiple loops in a nest without introducing nested parallelism.

### Syntax

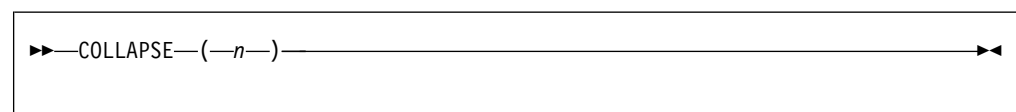

*n* is a positive constant integer expression

## Rules

- Only one collapse clause is allowed on a worksharing **DO** or **PARALLEL DO** directive
- The specified number of loops must be present lexically. That is, none of the loops can be in a called subroutine.
- The loops must form a rectangular iteration space and the bounds and stride of each loop must be invariant over all the loops.
- If the loop indices are of different size, the index with the largest size will be used for the collapsed loop.
- The loops must be perfectly nested; that is, there is no intervening code nor any OpenMP directive between the loops which are collapsed.
- The associated do-loops must be structured blocks. Their execution must not be terminated by an **EXIT** statement.
- If multiple loops are associated with the loop construct, only an iteration of the innermost associated loop may be curtailed by a **CYCLE** statement. If multiple loops are associated with the loop construct, there must be no branches to any of the loop termination statements except for the innermost associated loop.

### Ordered construct

During execution of an iteration of a loop or a loop nested within a loop region, the executing thread must not execute more than one ordered region which binds to the same loop region. As a consequence, if multiple loops are associated with the loop construct by a collapse clause, the ordered construct has to be located inside all associated loops.

### LASTPRIVATE clause

When a **LASTPRIVATE** clause appears on the directive that identifies a work-sharing construct, the value of each new list item from the sequentially last iteration of the associated loops is assigned to the original list item even if a collapse clause is associated with the loop

### Other SMP and performance directives

The **STREAM\_UNROLL**, **UNROLL**, **UNROLL\_AND\_FUSE**, and **NOUNROLL\_AND\_FUSE** directives cannot be used for any of the loops associated with the **COLLAPSE** clause loop nest. The **INDEPENDENT** directive can be used for any of the loops associated with the **COLLAPSE** clause.

## Examples

In Example 1 and Example 2 the loops over k and j are collapsed and their iteration space is executed by all threads of the current team.

### Example 1

```
!$omp do collapse(2) private(i,j,k)
do k = kl, ku, ks
  do j = jl, ju, js
    do i = il, iu, is
      call bar(a,i,j,k)
    enddo
  enddo
enddo
!$omp end do
```

### Example 2

```

program test
!$omp parallel
!$omp do private(j,k) collapse(2) lastprivate(jlast, klast)
  do k = 1,2
    do j = 1,3
      jlast=j
      klast=k
    enddo
  enddo
!$omp end do
!$omp single
  print *, klast, jlast
!$omp end single
!$omp end parallel
end program test

```

Output:

2 3

### Example 3

As both loops are collapsed into one, the ordered construct has to be inside all loops associated with the for construct. As an iteration may not execute more than one ordered region, this program would be incorrect without the collapse(2) clause.

```

program test
!$omp parallel num_threads(2)
!$omp do collapse(2) ordered private(j,k) schedule(static,3)
  do k = 1,3
    do j = 1,2
!$omp ordered
      print *, k, j
!$omp end ordered
    enddo
  enddo
!$omp end do
!$omp end parallel
end program test

```

Output:

```

1 1
1 2
2 1
2 2
3 1
3 2

```

#### Related reference:

ORDERED / END ORDERED

DO / END DO

PARALLEL DO / END PARALLEL DO

## COPYIN

### Purpose

If you specify the **COPYIN** clause, the master thread's copy of each variable, or common block declared in the *copyin\_entity\_list* is duplicated at the beginning of a parallel region. Each thread in the team that will execute within that parallel region receives a private copy of all entities in the *copyin\_entity\_list*. All variables declared in the *copyin\_entity\_list* must be **THREADPRIVATE** or members of a common

block that appears in a **THREADPRIVATE** directive.

## Syntax

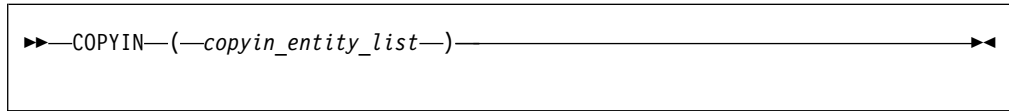

*copyin\_entity*

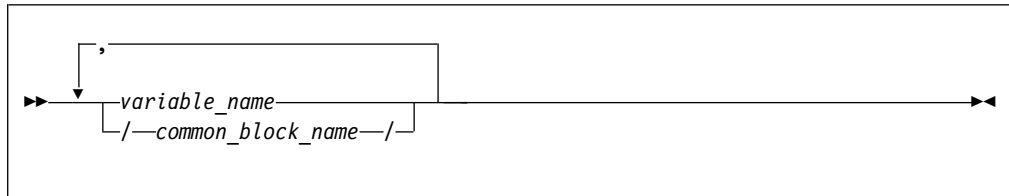

*variable*

is a **THREADPRIVATE** variable, or **THREADPRIVATE** variable in a common block.

*common\_block\_name*

is a **THREADPRIVATE** common block name.

## Rules

If you specify a **COPYIN** clause, you cannot:

- specify the same entity name more than once in a *copyin\_entity\_list*.
- specify the same entity name in separate **COPYIN** clauses on the same directive.
- specify both a common block name and any variable within that same named common block in a *copyin\_entity\_list*.
- specify both a common block name and any variable within that same named common block in different **COPYIN** clauses on the same directive.
- specify a variable that contains **ALLOCATABLE** components.

When the master thread of a team of threads reaches a directive containing the **COPYIN** clause, each thread's private copy of a variable or common block specified in the **COPYIN** clause will have the same value as the master thread's copy.

On entry into any parallel region, a **THREADPRIVATE** variable, or a variable in a **THREADPRIVATE** common block is subject to the following criteria when declared in a **COPYIN** clause:

- If the variable has the **POINTER** attribute and the master thread's copy of the variable is associated with a target, then each copy of that variable is associated with the same target. If the master thread's pointer is disassociated, then each copy of that variable is disassociated. If the master thread's copy of the variable has an undefined association status, then each copy of that variable has an undefined association status.
- Each copy of a variable without the **POINTER** attribute becomes defined with the value of the master thread's copy as if by intrinsic assignment.

If an allocatable array is specified in a **COPYIN** clause and it is allocated on entry into a parallel region, each thread copy of that array must be allocated with the same bounds and rank.

**Related reference:**

PARALLEL / END PARALLEL

PARALLEL DO / END PARALLEL DO

PARALLEL SECTIONS / END PARALLEL SECTIONS

PARALLEL WORKSHARE / END PARALLEL WORKSHARE

## COPYPRIVATE

### Purpose

If you specify the **COPYPRIVATE** clause, the value of a private variable or pointer to a shared object from one thread in a team is copied into the corresponding variables of all other threads in that team. If the variable in *copyprivate\_entity\_list* is not a pointer, then the corresponding variables of all threads within that team are defined with the value of that variable. If the variable is a pointer, then the corresponding variables of all threads within that team are defined with the association status of the pointer. Integer pointers and assumed-size arrays must not appear in *copyprivate\_entity\_list*.

### Syntax

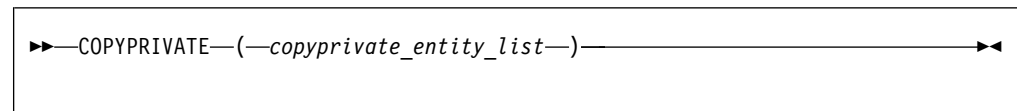

*copyprivate\_entity*

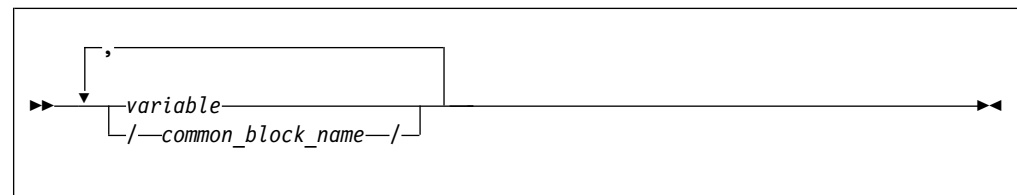

*variable*

is a private variable within the enclosing parallel region

*common\_block\_name*

is a **THREADPRIVATE** common block name

### Rules

If a common block is part of the *copyprivate\_entity\_list*, then it must appear in a **THREADPRIVATE** directive. Furthermore, the **COPYPRIVATE** clause treats a common block as if all variables within its *object\_list* were specified in the *copyprivate\_entity\_list*.

A **COPYPRIVATE** clause must occur on an **END SINGLE** directive at the end of a **SINGLE** construct. The compiler evaluates a **COPYPRIVATE** clause before any threads have passed the implied **BARRIER** directive at the end of that construct.

The variables you specify in *copyprivate\_entity\_list* must not appear in a **PRIVATE** or **FIRSTPRIVATE** clause for the **SINGLE** construct. If the **END SINGLE** directive occurs within the dynamic extent of a parallel region, the variables you specify in *copyprivate\_entity\_list* must be private within that parallel region.

A **COPYPRIVATE** clause must not appear on the same **END SINGLE** directive as a **NOWAIT** clause.

A **THREADLOCAL** common block, or members of that common block, are not permitted as part of a **COPYPRIVATE** clause.

If an allocatable array appears on a **COPYPRIVATE** clause, it must have an allocation status of allocated with the same bounds and rank in all threads that are affected by the **COPYPRIVATE** clause.

**Related reference:**

**SINGLE / END SINGLE**

## DEFAULT

### Purpose

If you specify the **DEFAULT** clause, all variables in the lexical extent of the parallel construct will have a scope attribute of *default\_scope\_attr*.

If you specify **DEFAULT(NONE)**, there is no default scope attribute. Therefore, you must explicitly list each variable you use in the lexical extent of the parallel construct in a data scope attribute clause on the parallel construct, unless the variable is:

- **THREADPRIVATE**
- A member of a **THREADPRIVATE** common block.
- A pointee
- A loop iteration variable used only as a loop iteration variable for:
  - Sequential loops in the lexical extent of the parallel region, or,
  - Parallel do loops that bind to the parallel region
- A variable that is only used in work-sharing constructs that bind to the parallel region, and is specified in a data scope attribute clause for each of the work-sharing constructs.

The **DEFAULT** clause specifies that all variables in the parallel construct share the same default scope attribute of either **FIRSTPRIVATE**, **PRIVATE**, **SHARED**, or no default scope attribute.

### Syntax

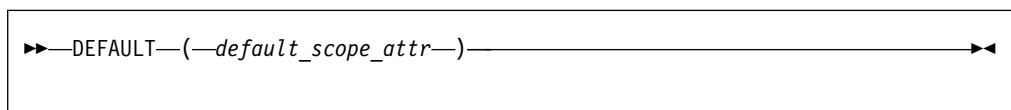

*default\_scope\_attr*  
is one of **FIRSTPRIVATE**, **PRIVATE**, **SHARED**, or **NONE**

## Rules

If you specify **DEFAULT(NONE)** on a directive you must specify all named variables and all the leftmost names of referenced array sections, array elements, structure components, or substrings in the lexical extent of the directive construct in a **FIRSTPRIVATE**, **LASTPRIVATE**, **PRIVATE**, **REDUCTION**, or **SHARED** clause.

If you specify **DEFAULT(FIRSTPRIVATE)** on a directive, all named variables and all leftmost names of referenced array sections, array elements, structure components, or substrings in the lexical extent of the directive construct, including common block and use associated variables, but excluding **POINTEEs** and **THREADLOCAL** common blocks, have a **FIRSTPRIVATE** attribute to a thread as if they were listed explicitly in a **FIRSTPRIVATE** clause.

If you specify **DEFAULT(PRIVATE)** on a directive, all named variables and all leftmost names of referenced array sections, array elements, structure components, or substrings in the lexical extent of the directive construct, including common block and use associated variables, but excluding **POINTEEs** and **THREADLOCAL** common blocks, have a **PRIVATE** attribute to a thread as if they were listed explicitly in a **PRIVATE** clause.

If you specify **DEFAULT(SHARED)** on a directive, all named variables and all leftmost names of referenced array sections, array elements, structure components, or substrings in the lexical extent of the directive construct, excluding **POINTEEs** have a **SHARED** attribute to a thread as if they were listed explicitly in a **SHARED** clause.

The default behavior will be **DEFAULT(SHARED)** if you do not explicitly indicate a **DEFAULT** clause on a directive.

## Example for OpenMP

The following example demonstrates the use of **DEFAULT(NONE)** for OpenMP, and some of the rules for specifying the data scope attributes of variables in the parallel region.

```
PROGRAM MAIN
  COMMON /COMBLK/ abc(10), def

  ! The loop iteration variable, i, is not required to be
  ! in data scope attribute clause.
  $OMP PARALLEL DEFAULT(NONE) SHARED(ABC)

  ! def is specified on the work-sharing DO, and is not required to be
  ! specified in a data scope attribute clause on the parallel region.
  !$OMP DO FIRSTPRIVATE(def)
  DO i = 1,10
    ABC(i) = def
  END DO
  !$OMP END PARALLEL
END PROGRAM
```

### Related reference:

PARALLEL / END PARALLEL

PARALLEL DO / END PARALLEL DO

PARALLEL SECTIONS / END PARALLEL SECTIONS

PARALLEL WORKSHARE / END PARALLEL WORKSHARE

“TASK / END TASK” on page 145

## FINAL

### Purpose

The **FINAL** clause is used with the **TASK** directive. If you specify a **FINAL** clause and the *scalar\_logical\_expr* evaluates to `.TRUE.`, the generated task is a final task. All task constructs encountered inside a final task create final and included tasks.

### Syntax

```
▶▶FINAL—(—scalar_logical_expr—)▶▶
```

### Rules

You can specify only one **FINAL** clause on the **TASK** directive.

### Related reference

“**TASK / END TASK**” on page 145

## FIRSTPRIVATE

### Purpose

If you use the **FIRSTPRIVATE** clause, each thread has its own initialized local copy of the variables and common blocks in *data\_scope\_entity\_list*.

The **FIRSTPRIVATE** clause can be specified for the same variables as the **PRIVATE** clause, and functions in a manner similar to the **PRIVATE** clause. The exception is the status of the variable upon entry into the directive construct; the **FIRSTPRIVATE** variable exists and is initialized for each thread entering the directive construct.

### Syntax

```
▶▶FIRSTPRIVATE—(—data_scope_entity_list—)▶▶
```

### Rules

A variable in a **FIRSTPRIVATE** clause must not be any of the following elements:

- A pointee
- An assumed-size array
- A **THREADLOCAL** common block
- A **THREADPRIVATE** common block or its members
- A **THREADPRIVATE** variable
- An allocatable scalar object

You cannot specify a variable in a **FIRSTPRIVATE** clause of a parallel construct if both the following conditions are true:



- The variable appears in a namelist statement, variable format expression or in an expression for a statement function definition.
- You reference the statement function, the variable format expression through formatted I/O, or the namelist through namelist I/O, within the parallel construct.

For a variable specified in the **FIRSTPRIVATE** clause, the status of the private copies is determined as follows:

- If the variable has the **POINTER** attribute, the private copies of the **FIRSTPRIVATE** variable receive the same association status as the original copy as if by pointer assignment.
- If the variable does not have the **POINTER** attribute, the initialization of the private copies occurs as if by intrinsic assignment. However, if the original variable is not currently allocated, the private copies have the same allocation status as the original copy.

If an allocatable array appears on a **FIRSTPRIVATE** clause, it must have an allocation status of allocated upon entrance into the parallel construct that contains the **FIRSTPRIVATE** clause.

When individual members of a common block are privatized, the storage of the specified variable is no longer associated with the storage of the common block.

Any variable that is storage associated with a **FIRSTPRIVATE** variable is undefined on entrance into the parallel construct.

If one of the entities involved in an asynchronous I/O operation is a **FIRSTPRIVATE** variable, a subobject of a **FIRSTPRIVATE** variable, or a pointer that is associated with a **FIRSTPRIVATE** variable, the matching implied wait or **WAIT** statement must be executed before the end of the thread.

If a directive construct contains a **FIRSTPRIVATE** argument to a Message Passing Interface (MPI) routine performing non-blocking communication, the MPI communication must complete before the end of the construct.

**Related reference:**

DO / END DO  
 PARALLEL / END PARALLEL  
 PARALLEL DO / END PARALLEL DO  
 PARALLEL SECTIONS / END PARALLEL SECTIONS  
 PARALLEL WORKSHARE / END PARALLEL WORKSHARE  
 SECTIONS / END SECTIONS  
 SINGLE / END SINGLE  
 "TASK / END TASK" on page 145

## IF

### Purpose

If you specify the **IF** clause, the runtime environment evaluates whether the *scalar\_logical\_expression* is true or false. If *scalar\_logical\_expression* is:

- true, the block is run in parallel.
- false, the containing region is suspended and the generated task is immediately run as though it is in a distinct task region.

Note that for the **TASK** directive, if the IF clause is evaluated to true, the block is not required to run in parallel.

## Syntax

```
▶▶—IF—(—scalar_logical_expression—)————▶▶
```

## Rules

The **IF** clause can be used in the **PARALLEL**, **PARALLEL DO**, **PARALLEL SECTIONS**, **PARALLEL WORKSHARE**, and **TASK** directives.

The **IF** clause may appear at most once in any directive.

By default, a nested parallel loop is serialized, regardless of the setting of the **IF** clause. You can change this default by using the **-qsmp=nested\_par** compiler option.

An **IF** expression is evaluated outside of the context of the parallel construct. Any function reference in the **IF** expression must not have side effects.

### Related reference:

“**PARALLEL / END PARALLEL**” on page 126

“**PARALLEL DO / END PARALLEL DO**” on page 128

“**PARALLEL SECTIONS / END PARALLEL SECTIONS**” on page 132

“**PARALLEL WORKSHARE / END PARALLEL WORKSHARE**” on page 134

“**TASK / END TASK**” on page 145

## LASTPRIVATE

### Purpose

If you use the **LASTPRIVATE** clause, each variable and common block in *data\_scope\_entity\_list* is **PRIVATE**, and the last value of each variable in *data\_scope\_entity\_list* can be referred to outside of the construct of the directive. If you use the **LASTPRIVATE** clause with **DO** or **PARALLEL DO**, the last value is the value of the variable after the last sequential iteration of the loop. If you use the **LASTPRIVATE** clause with **SECTIONS** or **PARALLEL SECTIONS**, the last value is the value of the variable after the last **SECTION** of the construct. If the last iteration of the loop or last section of the construct does not define a **LASTPRIVATE** variable, the variable is undefined after the loop or construct.

The **LASTPRIVATE** clause functions in a manner similar to the **PRIVATE** clause and you should specify it for variables that match the same criteria. The exception is in the status of the variable on exit from the directive construct. The compiler determines the last value of the variable, and takes a copy of that value which it saves in the named variable for use after the construct. A **LASTPRIVATE** variable is undefined on entry to the construct if it is not a **FIRSTPRIVATE** variable.

## Syntax

```
▶▶—LASTPRIVATE—(—data_scope_entity_list—)————▶▶
```

## Rules

A variable in a **LASTPRIVATE** clause must not be any of the following elements:

- A pointee
- An allocatable scalar object
- An assumed-size array
- A **THREADLOCAL** common block
- A **THREADPRIVATE** common block or its members
- A **THREADPRIVATE** variable

You cannot specify a variable in a **LASTPRIVATE** clause of a parallel construct if both the following conditions are true:

- The variable appears in a namelist statement, variable format expression or in an expression for a statement function definition.
- You reference the statement function, the variable format expression through formatted I/O, or the namelist through namelist I/O, within the parallel construct.

A **LASTPRIVATE** variable must be definable.

For a variable specified in a **LASTPRIVATE** clause,

- If the variable has the **POINTER** attribute, the original variable is updated as if by pointer assignment.
- If the variable does not have the **POINTER** attribute, the original variable is updated as if by intrinsic assignment.

If an allocatable array appears on a **LASTPRIVATE** clause, its allocation status must be allocated when it enters into the parallel construct that contains the **LASTPRIVATE** clause. The private copies of the **LASTPRIVATE** variable in the sequentially last iteration or lexically last section must have an allocation status of allocated. They must have the same bounds and rank as the corresponding **LASTPRIVATE** variable when they exit from that iteration or section.

When individual members of a common block are privatized, the storage of the specified variable is no longer associated with the storage of the common block.

Any variable that is storage associated with a **LASTPRIVATE** variable is undefined on entrance into the parallel construct.

If you specify a variable as **LASTPRIVATE** on a work-sharing directive, and you have specified a **NOWAIT** clause on that directive, you cannot use that variable between the end of the work-sharing construct and a **BARRIER** directive.

Variables that you specify as **LASTPRIVATE** to a parallel construct become defined at the end of the construct. If you have concurrent definitions or uses of **LASTPRIVATE** variables on multiple threads, you must ensure that the threads are synchronized at the end of the construct when the variables become defined. For

example, if multiple threads encounter a **PARALLEL** construct with a **LASTPRIVATE** variable, you must synchronize the threads when they reach the **END PARALLEL** directive, because the **LASTPRIVATE** variable becomes defined at **END PARALLEL**. Therefore the whole **PARALLEL** construct must be enclosed within a synchronization construct.

If one of the entities involved in an asynchronous I/O operation is a **LASTPRIVATE**, a subobject of a **LASTPRIVATE** variable, or a pointer that is associated with a **LASTPRIVATE** variable, the matching implied wait or **WAIT** statement must be executed before the end of the thread.

If a directive construct contains a **LASTPRIVATE** argument to a Message Passing Interface (MPI) routine performing non-blocking communication, the MPI communication must complete before the end of that construct.

### Example for OpenMP

The following example shows the proper use of a **LASTPRIVATE** variable after a **NOWAIT** clause.

```
!$OMP PARALLEL
!$OMP DO LASTPRIVATE(k)
DO i = 1,10
  k = i + 1
END DO

!$OMP END DO NOWAIT
k = ... **ERROR**      ! The reference to k must occur after a barrier.
!$OMP BARRIER
k = ...                ! this reference to k is valid.
!$OMP END PARALLEL
END
```

#### Related reference:

DO / END DO

PARALLEL DO / END PARALLEL DO

PARALLEL SECTIONS / END PARALLEL SECTIONS

SECTIONS / END SECTIONS

## MERGEABLE

### Purpose

The **MERGEABLE** clause is used with the **TASK** directive. If you specify a **MERGEABLE** clause and the generated task is an undeferred task or an included task, a merged task might be generated.

### Syntax

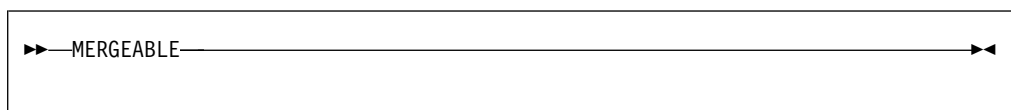

### Related reference

“**TASK / END TASK**” on page 145

## NUM\_THREADS

### Purpose

The **NUM\_THREADS** clause allows you to specify the number of threads used in a parallel region. Subsequent parallel regions are not affected. The **NUM\_THREADS** clause takes precedence over the number of threads specified using the **omp\_set\_num\_threads** library routine or the environment variable **OMP\_NUM\_THREADS**.

### Syntax

```
▶▶—NUM_THREADS—(—scalar_integer_expression—)————▶▶
```

### Rules

The value of *scalar\_integer\_expression* must be a positive integer. Evaluation of the expression occurs outside the context of the parallel region. Any function calls that appear in the expression and change the value of a variable referenced in the expression will have unspecified results.

If you are using the environment variable **OMP\_DYNAMIC** to enable dynamic threads, *scalar\_integer\_expression* defines the maximum number of threads available in the parallel region.

You must specify the **omp\_set\_nested** library routine or set the **OMP\_NESTED** environment variable when including the **NUM\_THREADS** clause as part of a nested parallel regions; otherwise, the execution of that parallel region is serialized.

#### Related reference:

PARALLEL / END PARALLEL

PARALLEL DO / END PARALLEL DO

PARALLEL SECTIONS / END PARALLEL SECTIONS

PARALLEL WORKSHARE / END PARALLEL WORKSHARE

## ORDERED

### Purpose

Specifying the **ORDERED** clause on a work-sharing construct allows you to specify the **ORDERED** directive within the dynamic extent of a parallel loop.

### Syntax

```
▶▶—ORDERED————▶▶
```

### Rules

The **ORDERED** clause applies to the following directives:

- “DO / END DO” on page 116
- “PARALLEL DO / END PARALLEL DO” on page 128

**Related reference:**

“DO / END DO” on page 116

“PARALLEL DO / END PARALLEL DO” on page 128

## PRIVATE

### Purpose

If you specify the **PRIVATE** clause on one of the directives listed below, each thread in a team has its own uninitialized local copy of the variables and common blocks in *data\_scope\_entity\_list*.

You should specify a variable in the **PRIVATE** clause if its value is calculated by a single thread and that value is not dependent on any other thread, if it is defined before it is used in the construct, and if its value is not used after the construct ends. Copies of the **PRIVATE** variable exist, locally, on each thread. Each thread receives its own uninitialized copy of the **PRIVATE** variable. All thread variables within the lexical extent of the directive construct have the **PRIVATE** attribute by default.

### Syntax

```
▶▶—PRIVATE—(—data_scope_entity_list—)————▶▶
```

### Rules

A variable in the **PRIVATE** clause must not be any of the following elements:

- A pointee
- An assumed-size array
- A **THREADLOCAL** common block
- A **THREADPRIVATE** common block or its members
- A **THREADPRIVATE** variable or the variable equivalenced with a **THREADPRIVATE** variable

You cannot specify a variable in a **PRIVATE** clause of a parallel construct if:

- the variable appears in a namelist statement, variable format expression or in an expression for a statement function definition, and,
- you reference the statement function, the variable format expression through formatted I/O, or the namelist through namelist I/O, within the parallel construct.

If one of the entities involved in an asynchronous I/O operation is a **PRIVATE** variable, a subobject of a **PRIVATE** variable, or a pointer that is associated with a **PRIVATE** variable, the matching implied wait or **WAIT** statement must be executed before the end of the thread.

When individual members of a common block are privatized, the storage of the specified variable is no longer associated with the storage of the common block.

A variable that appears in the **REDUCTION** clause of a parallel construct can also appear in a **PRIVATE** clause on a work-sharing construct.

If a directive construct contains a **PRIVATE** argument to a Message Passing Interface (MPI) routine performing non-blocking communication, the MPI communication must complete before the end of that construct.

A variable name in the *data\_scope\_entity\_list* of the **PRIVATE** clause can be an allocatable array. If the allocatable array is allocated on entry to a parallel region, the private copies of the array has an allocation status of allocated and has the same rank and bounds as the **PRIVATE** variable. If the allocatable array is deallocated on entry to a parallel region, the private copies of the array has an allocation status of deallocated.

Local variables without the **SAVE** or **STATIC** attributes in referenced subprograms in the dynamic extent of a directive construct have an implicit **PRIVATE** attribute.

## Examples for OpenMP

**Example 1:** The following example demonstrates the proper use of a **PRIVATE** variable that is used to define a statement function. A commented line shows the invalid use. Since *J* appears in a statement function, the statement function cannot be referenced within the parallel construct for which *J* is **PRIVATE**.

```
INTEGER :: arr(10), j = 17
ISTFNC() = j

!$OMP PARALLEL DO PRIVATE(j)
DO i = 1, 10
  j = i
  ! arr(i) = ISTFNC() **ERROR** A reference to ISTFNC would
  ! make the PRIVATE(J) clause invalid.
  ARR(i) = j
END DO
PRINT *, arr
END
```

**Example 2:** The following example demonstrates the use of allocatable arrays on a **PRIVATE** clause:

```
USE OMP_LIB
REAL, ALLOCATABLE :: temp(:, :)
REAL :: arr(4, 20, 20)
INTEGER :: thd

ALLOCATE(temp(20, 20))
!$OMP PARALLEL PRIVATE(thd, temp) NUM_THREADS(4)

! Private copies of "temp" are allocated with the same
! bounds and shape of the original "temp".
thd = OMP_GET_THREAD_NUM()
IF(MOD(thd, 2) .EQ. 0) THEN
  temp = RESHAPE((/i, i=1, 400/), (/20, 20/))
ELSE
  temp = RESHAPE((/i, i=1, 800, 2/), (/20, 20/))
ENDIF
arr(thd + 1, :, :) = temp

! Private copies of "temp" are deallocated.
!$OMP END PARALLEL
DEALLOCATE(temp)
END
```

**Note:** If the machine has less than 4 CPUs, you must set *OMP\_THREAD\_LIMIT=4*.

**Example 3:** The following example demonstrates the persistence of the original value of the **PRIVATE** variables after exit from a parallel region:

```
PROGRAM MAIN
  INTEGER :: i, j

  i = 1
  j = 2
!$OMP PARALLEL PRIVATE(i, j)
  i = 3
  j = j + 2
!$OMP END PARALLEL
  PRINT *, i, j           ! Output: 1 2
END PROGRAM
```

**Related reference:**

DO / END DO  
 PARALLEL / END PARALLEL  
 PARALLEL DO / END PARALLEL DO  
 PARALLEL SECTIONS / END PARALLEL SECTIONS  
 PARALLEL WORKSHARE / END PARALLEL WORKSHARE  
 SECTIONS / END SECTIONS  
 SINGLE / END SINGLE  
 "TASK / END TASK" on page 145

## REDUCTION

### Purpose

The **REDUCTION** clause updates named variables declared on the clause within the directive construct. Intermediate values of **REDUCTION** variables are not used within the parallel construct, other than in the updates themselves.

### Syntax

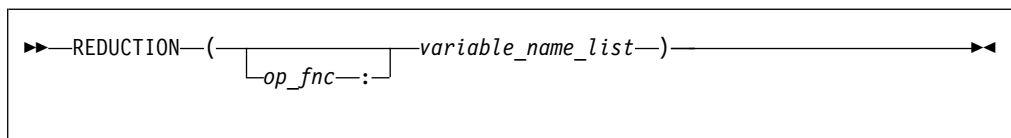

*op\_fnc* is a *reduction\_op* or a *reduction\_function* that appears in all **REDUCTION** statements involving this variable. You must not specify more than one **REDUCTION** operator or function for a variable in the directive construct. To maintain OpenMP API compliance, you must specify *op\_fnc* for the **REDUCTION** clause.

A **REDUCTION** statement can have one of the following forms:



$\rightarrow$  *reduction\_var\_ref* = *expr* *reduction\_op* *reduction\_var\_ref*  $\rightarrow$   
 $\rightarrow$  *reduction\_var\_ref* = *reduction\_var\_ref* *reduction\_op* *expr*  $\rightarrow$   
 $\rightarrow$  *reduction\_var\_ref* = *reduction\_function* (*expr*, *reduction\_var\_ref*)  $\rightarrow$   
 $\rightarrow$  *reduction\_var\_ref* = *reduction\_function* (*reduction\_var\_ref*, *expr*)  $\rightarrow$

where:

*reduction\_var\_ref*  
is a variable or subobject of a variable that appears in a **REDUCTION** clause

*reduction\_op*  
is one of the intrinsic operators: +, -, \*, **.AND.**, **.OR.**, **.EQV.**, **.NEQV.**, or **.XOR.**  
when *reduction\_op* is an intrinsic operator, it should be the last operation performed on the right side.

*reduction\_function*  
is one of the intrinsic procedures: **MAX**, **MIN**, **IAND**, **IOR**, or **IEOR**.

*expr* should not contain references to *reduction\_var\_ref*

The canonical initialization value of each of the operators and intrinsics are shown in the following table. The actual initialization value will be consistent with the data type of your corresponding **REDUCTION** variable.

| Intrinsic Operator  | Initialization                |
|---------------------|-------------------------------|
| +                   | 0                             |
| *                   | 1                             |
| -                   | 0                             |
| <b>.AND.</b>        | <b>.TRUE.</b>                 |
| <b>.OR.</b>         | <b>.FALSE.</b>                |
| <b>.EQV.</b>        | <b>.TRUE.</b>                 |
| <b>.NEQV.</b>       | <b>.FALSE.</b>                |
| <b>.XOR.</b>        | <b>.FALSE.</b>                |
| Intrinsic Procedure | Initialization                |
| MAX                 | Smallest representable number |
| MIN                 | Largest representable number  |
| IAND                | All bits on                   |
| IOR                 | 0                             |
| IEOR                | 0                             |

## Rules

The following rules apply to **REDUCTION** statements:

- A variable in the **REDUCTION** clause must only occur in a **REDUCTION** statement within the directive construct on which the **REDUCTION** clause appears.
- The two *reduction\_var\_refs* that appear in a **REDUCTION** statement must be lexically identical.
- You cannot use the following form of the **REDUCTION** statement:  
 $reduction\_var\_ref = expr\ operator\ reduction\_var\_ref$ , where *operator* is any operator other than *reduction\_op*.

When you specify individual members of a common block in a **REDUCTION** clause, the storage of the specified variable is no longer associated with the storage of the common block.

Any variable you specify in a **REDUCTION** clause of a work-sharing construct must be shared in the enclosing **PARALLEL** construct.

A variable that appears in the **REDUCTION** clause of a parallel construct can also appear in a **PRIVATE** clause on a work-sharing construct.

If you use a **REDUCTION** clause on a construct that has a **NOWAIT** clause, the **REDUCTION** variable remains undefined until a barrier synchronization has been performed to ensure that all threads have completed the **REDUCTION** clause.

A **REDUCTION** variable must not appear in a **FIRSTPRIVATE**, **PRIVATE**, or **LASTPRIVATE** clause of another construct within the dynamic extent of the construct in which it appeared as a **REDUCTION** variable.

If you specify *op\_fnc* for the **REDUCTION** clause, each variable in the *variable\_name\_list* must be of intrinsic type. The variable can only appear in a **REDUCTION** statement within the lexical extent of the directive construct. You must specify *op\_fnc* if the directive uses the *trigger\_constant* **\$OMP**.

The **REDUCTION** clause specifies named variables that appear in reduction operations. The compiler will maintain local copies of such variables, but will combine them upon exit from the construct. The intermediate values of the **REDUCTION** variables are combined in random order, dependent on which threads finish their calculations first. Therefore, there is no guarantee that bit-identical results will be obtained from one parallel run to another. This is true even if the parallel runs use the same number of threads, scheduling type, and chunk size.

Variables that you specify as **REDUCTION** or **LASTPRIVATE** to a parallel construct become defined at the end of the construct. If you have concurrent definitions or uses of **REDUCTION** or **LASTPRIVATE** variables on multiple threads, you must ensure that the threads are synchronized at the end of the construct when the variables become defined. For example, if multiple threads encounter a **PARALLEL** construct with a **REDUCTION** variable, you must synchronize the threads when they reach the **END PARALLEL** directive, because the **REDUCTION** variable becomes defined at **END PARALLEL**. Therefore the whole **PARALLEL** construct must be enclosed within a synchronization construct.

If an allocatable array appears on a **REDUCTION** clause, it must have an allocation status of allocated upon entrance into the construct that contains the **REDUCTION** clause. Additionally, the private copies of the **REDUCTION** variable must not be deallocated or allocated within the region.

A variable in the **REDUCTION** clause must be of intrinsic type. A variable in the **REDUCTION** clause, or any element thereof, must not be any of the following:

- A pointee
- An assumed-size array
- A **THREADLOCAL** common block
- A **THREADPRIVATE** common block or its members
- A **THREADPRIVATE** variable
- An allocatable scalar object
- A Fortran 90 pointer

These rules describe the use of **REDUCTION** on OpenMP directives. If you are using the **REDUCTION** clause on the **INDEPENDENT** directive, see the **INDEPENDENT** directive in the *XL Fortran Language Reference* directive.

**Related reference:**

DO / END DO

PARALLEL / END PARALLEL

PARALLEL DO / END PARALLEL DO

PARALLEL SECTIONS / END PARALLEL SECTIONS

PARALLEL WORKSHARE / END PARALLEL WORKSHARE

SECTIONS / END SECTIONS

## SCHEDULE

### Purpose

You can use the **SCHEDULE** clause to specify the chunking method for parallelization. Work is assigned to threads in different manners depending on the scheduling type or chunk size used.

### Syntax

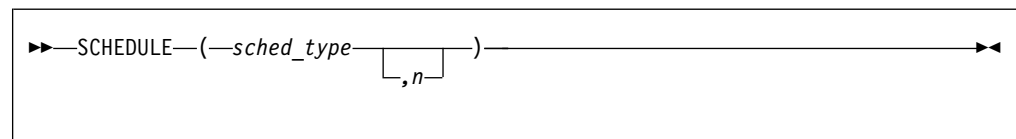

*sched\_type*

is one of **AFFINITY**, **AUTO**, **DYNAMIC**, **GUIDED**, **RUNTIME**, or **STATIC**.

*n*

must be a positive scalar integer expression; do not specify *n* for the **AUTO** and **RUNTIME** schedule type. If you are using the *trigger\_constant* **\$OMP**, do not specify the scheduling type **AFFINITY**.

### **AFFINITY**

The iterations of a loop are initially divided into *number\_of\_threads* partitions, containing  $\text{CEILING}(\text{number\_of\_iterations} / \text{number\_of\_threads})$  iterations. Each partition is initially assigned to a thread, and is then further subdivided into chunks containing *n* iterations, if *n* has been specified. If *n* has not been specified, then the chunks consist of  $\text{CEILING}(\text{number\_of\_iterations\_remaining\_in\_partition} / 2)$  loop iterations.

When a thread becomes free, it takes the next chunk from its initially assigned partition. If there are no more chunks in that partition, then the thread takes the next available chunk from a partition that is initially assigned to another thread.

Threads that are active will complete the work in a partition that is initially assigned to a sleeping thread.

**Note:** This scheduling type has been deprecated and might be removed in a future release. You can use the **GUIDED** scheduling type for a similar functionality.

## **AUTO**

The compiler and runtime system choose the most appropriate mapping of iteration to threads for each loop.

## **DYNAMIC**

If  $n$  has been specified, the iterations of a loop are divided into chunks containing  $n$  contiguous iterations each except for the last chunk. If  $n$  is not specified, the default chunk size is 1 iteration.

Chunks are assigned to threads on a "first-come, first-do" basis as threads become available. Chunks of the remaining work are assigned to available threads until all work has been assigned.

## **GUIDED**

If you specify a value for  $n$ , the iterations of a loop are divided into chunks such that the size of each successive chunk is exponentially decreasing.  $n$  specifies the size of the smallest chunk, except possibly the last. If you do not specify a value for  $n$ , the default value is 1.

The size of the initial chunk is proportional to  $\text{CEILING}(\text{number\_of\_iterations} / \text{number\_of\_threads})$  iterations. Subsequent chunks are proportional to  $\text{CEILING}(\text{number\_of\_iterations\_remaining} / \text{number\_of\_threads})$  iterations. If  $n$  is greater than 1, each chunk must contain at least  $n$  consecutive iterations (except for the last chunk to be assigned, which can have fewer than  $n$  iterations). As each thread finishes a chunk, it dynamically obtains the next available chunk.

You can use guided scheduling in a situation in which multiple threads in a team might arrive at a **DO** work-sharing construct at varying times, and each iteration requires roughly the same amount of work. For example, if you have a **DO** loop preceded by one or more work-sharing **SECTIONS** or **DO** constructs with **NOWAIT** clauses, you can guarantee that no thread waits at the barrier longer than it takes another thread to execute its final iteration, or final  $k$  iterations if a chunk size of  $k$  is specified. The **GUIDED** schedule requires the fewest synchronizations of all the scheduling methods.

An  $n$  expression is evaluated outside of the context of the **DO** construct. Any function reference in the  $n$  expression must not have side effects.

The value of the  $n$  parameter on the **SCHEDULE** clause must be the same for all of the threads in the team.

## **RUNTIME**

Determine the scheduling type at run time.

At run time, the scheduling type can be specified using the environment variable **OMP\_SCHEDULE**. If no scheduling type is specified using that variable, the default scheduling type used is **AUTO**.

## STATIC

If  $n$  has been specified, the iterations of a loop are divided into chunks that contain  $n$  iterations. Each thread is assigned chunks in a "round robin" fashion. This is known as block cyclic scheduling. If the value of  $n$  is 1, then the scheduling type is specifically referred to as cyclic scheduling.

If  $n$  has not been specified, the chunks will contain  $\text{FLOOR}(\text{number\_of\_iterations} / \text{number\_of\_threads})$  contiguous iterations. The first  $\text{REMAINDER}(\text{number\_of\_iterations}/\text{number\_of\_threads})$  chunks have one more iteration. Each thread is assigned a separate chunk. This is known as block cyclic scheduling.

If a thread is asleep and it has been assigned work, it will be awakened so that it may complete its work.

The **STATIC** schedule ensures that the same logical iteration numbers are assigned to threads in two work-sharing loop regions if the following conditions are satisfied:

- Both loop regions have the same number of loop iterations
- Both loop regions either have the same value of  $n$  specified, or have no  $n$  specified
- Both loop regions bind to the same parallel region

A data dependence between the same logical iterations in two such loops is guaranteed to be satisfied to allow the safe use of the **NOWAIT** clause. In addition, you must make sure that all three conditions mentioned above are satisfied to get the correct result.

Consecutive loop constructs with **STATIC** schedule with **NOWAIT** clause now guarantee the same iterations are being assigned to the same thread in the constructs.

For an example of the loop constructs that satisfy all three conditions, see "Example for OpenMP."

## Rules

You must not specify the **SCHEDULE** clause more than once for a particular **DO** directive.

## Example for OpenMP

The following example illustrates loop constructs that satisfy all three conditions listed in the **STATIC** section.

```
!$OMP PARALLEL
!$OMP DO SCHEDULE(STATIC)
  DO i = 1, n
    c(i) = (a(i) + b(i)) / 2.0;
  ENDDO
!$OMP END DO NOWAIT

!$OMP DO SCHEDULE(STATIC)
  DO i = 1, n
    z(i) = sqrt(c(i))
  ENDDO
!$OMP END DO
!$OMP END PARALLEL
```

**Related reference:**

“DO / END DO” on page 116

“PARALLEL DO / END PARALLEL DO” on page 128

## SHARED

### Purpose

All sections use the same copy of the variables and common blocks you specify in *data\_scope\_entity\_list*.

The **SHARED** clause specifies variables that must be available to all threads. If you specify a variable as **SHARED**, you are stating that all threads can safely share a single copy of the variable.

### Syntax

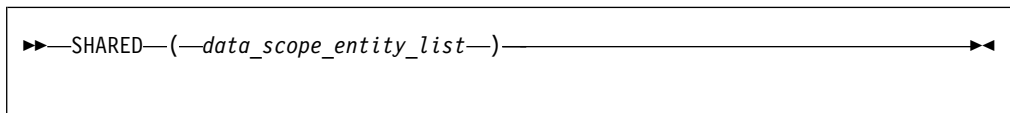

*data\_scope\_entity*

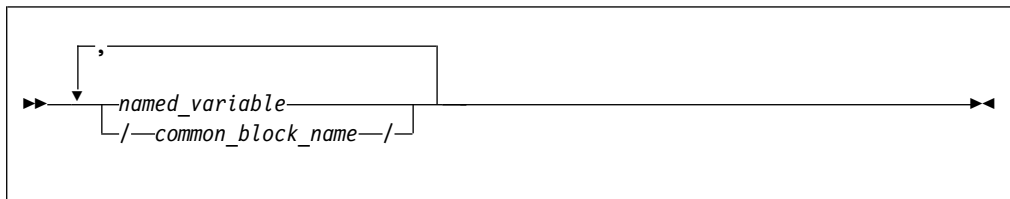

*named\_variable*

is a named variable that is accessible in the directive construct

*common\_block\_name*

is a common block name that is accessible in the directive construct

### Rules

A variable in the **SHARED** clause must not be either:

- A pointee
- A **THREADLOCAL** common block.
- A **THREADPRIVATE** common block or its members.
- A **THREADPRIVATE** variable.

If a **SHARED** variable, a subobject of a **SHARED** variable, or an object associated with a **SHARED** variable or subobject of a **SHARED** variable appears as an actual argument in a reference to a non-intrinsic procedure and:

- The actual argument is an array section with a vector subscript; or
- The actual argument is
  - An array section,
  - An assumed-shape array, or,

- A pointer array

and the associated dummy argument is an explicit-shape or assumed-size array;

then any references to or definitions of the shared storage that is associated with the dummy argument by any other thread must be synchronized with the procedure reference. In other words, you must structure your code in such a way that if a thread encounters a procedure reference, then the procedure call by that thread and any reference to or definition of the shared storage by any other thread will always occur in the same sequence. You can do this, for example, by placing the procedure reference after a **BARRIER**.

## Example for OpenMP

In the following example, the procedure reference with an array section actual argument is required to be synchronized with references to the dummy argument by placing the procedure reference in a critical section, because the associated dummy argument is an explicit-shape array.

```
INTEGER :: abc(10)

i = 2
j = 5

!$OMP PARALLEL DEFAULT(NONE), SHARED(abc, i, j)
!$OMP CRITICAL
! Actual argument is an array section.
! The procedure reference must be in a critical section.
CALL sub1(abc(i: j))
!$OMP END CRITICAL
!$OMP END PARALLEL

CONTAINS
  SUBROUTINE sub1(arr)
    INTEGER:: arr(1: 4)
    DO i = 1, 4
      arr(i) = i
    END DO
  END SUBROUTINE
END
```

### Related reference:

PARALLEL / END PARALLEL

PARALLEL DO / END PARALLEL DO

PARALLEL SECTIONS / END PARALLEL SECTIONS

PARALLEL WORKSHARE / END PARALLEL WORKSHARE

“TASK / END TASK” on page 145

## UNTIED

### Purpose

The **UNTIED** clause is used with the **TASK** directive. When a task region is suspended, untied tasks can be resumed by any thread in a team.

## Syntax

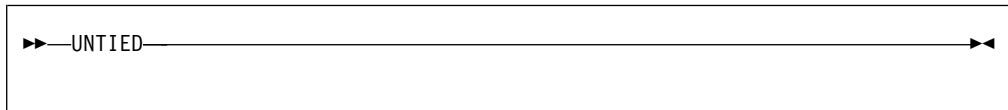

## Rules

The **UNTIED** clause is ignored if either of the following conditions is true:

- A **FINAL** clause is specified on the same task construct and the **FINAL** clause expression evaluates to `.TRUE.`.
- The task is an included task.

**Related reference:**

“TASK / END TASK” on page 145

---

## Routines for OpenMP

The OpenMP specification provides a number of routines that you can use to control and query the parallel execution environment, timing, and lock.

Parallel threads created by the runtime environment through the OpenMP interface are considered independent of the threads you create and control using calls to the **Fortran Pthreads library module**. References within the following descriptions to “serial portions of the program” refer to portions of the program that are executed by only one of the threads that have been created by the runtime environment. For example, you can create multiple threads by using `f_thread_create`. However, if you then call `omp_get_num_threads` from outside of an OpenMP parallel block, or from within a serialized nested parallel region, the function will return `1`, regardless of the number of threads that are currently executing.

OpenMP runtime library calls must not appear in **PURE** and **ELEMENTAL** procedures.

*Table 22. OpenMP execution environment routines*

|                                            |                                          |
|--------------------------------------------|------------------------------------------|
| • <code>omp_get_active_level</code>        | • <code>omp_get_schedule</code>          |
| • <code>omp_get_ancestor_thread_num</code> | • <code>omp_get_thread_num</code>        |
| • <code>omp_get_dynamic</code>             | • <code>omp_get_team_size</code>         |
| • <code>omp_get_level</code>               | • <code>omp_get_thread_limit</code>      |
| • <code>omp_get_max_active_levels</code>   | • <code>omp_in_final</code>              |
| • <code>omp_get_max_threads</code>         | • <code>omp_in_parallel</code>           |
| • <code>omp_get_nested</code>              | • <code>omp_set_dynamic</code>           |
| • <code>omp_get_num_procs</code>           | • <code>omp_set_max_active_levels</code> |
| • <code>omp_get_num_threads</code>         | • <code>omp_set_nested</code>            |
|                                            | • <code>omp_set_num_threads</code>       |
|                                            | • <code>omp_set_schedule</code>          |

Included in the OpenMP runtime library are two routines that support a portable wall-clock timer.

*Table 23. OpenMP timing routines*

|                              |                              |
|------------------------------|------------------------------|
| • <code>omp_get_wtick</code> | • <code>omp_get_wtime</code> |
|------------------------------|------------------------------|



The OpenMP runtime library also supports a set of simple and nestable lock routines. You must only lock variables through these routines. Simple locks may not be locked if they are already in a locked state. Simple lock variables are associated with simple locks and may only be passed to simple lock routines. Nestable locks may be locked multiple times by the same thread. Nestable lock variables are associated with nestable locks and may only be passed to nestable lock routines. Note that locks are now associated with task regions, and no longer with threads as such, in accordance with changes in the OMP standard.

For all the routines listed below, the lock variable is an integer whose **KIND** type parameter is denoted either by the symbolic constant **omp\_lock\_kind**, or by **omp\_nest\_lock\_kind**.

This variable is sized according to the compilation mode. It is set either to 4 for 32-bit applications or 8 for 64-bit applications.

Table 24. OpenMP simple lock routines

|                           |                         |
|---------------------------|-------------------------|
| • <b>omp_destroy_lock</b> | • <b>omp_test_lock</b>  |
| • <b>omp_init_lock</b>    | • <b>omp_unset_lock</b> |
| • <b>omp_set_lock</b>     |                         |

Table 25. OpenMP nestable lock routines

|                                |                              |
|--------------------------------|------------------------------|
| • <b>omp_destroy_nest_lock</b> | • <b>omp_test_nest_lock</b>  |
| • <b>omp_init_nest_lock</b>    | • <b>omp_unset_nest_lock</b> |
| • <b>omp_set_nest_lock</b>     |                              |

**Note:** You can define and implement your own versions of the OpenMP routines. However, by default, the compiler will substitute the XL Fortran versions of the OpenMP routines regardless of the existence of other implementations, unless you specify the **-qnoswapomp** compiler option. For more information, see *XL Fortran Compiler Reference*.

## omp\_destroy\_lock(svar)

### Purpose

The **omp\_destroy\_lock** subroutine disassociates a given lock variable from all locks. You must use **omp\_init\_lock** to reinitialize a lock variable that was destroyed with a call to **omp\_destroy\_lock** before using it again as a lock variable.

If you call **omp\_destroy\_lock** with an uninitialized lock variable, the result of the call is undefined.

### Class

Subroutine.

### Argument Type and Attributes

**svar**    Type integer with kind **omp\_lock\_kind**.

## Result Type and Attributes

None.

## Result Value

None.

## Examples

In the following example, threads and their associated tasks are generated by the parallel region, and one at a time, each task gains ownership of the lock associated with the lock variable LCK, prints the thread ID, and releases ownership of the lock.

```
      USE omp_lib
      INTEGER(kind=omp_lock_kind) LCK
      INTEGER ID
      CALL omp_init_lock(LCK)
!$OMP PARALLEL SHARED(LCK), PRIVATE(ID)
      ID = omp_get_thread_num()
      CALL omp_set_lock(LCK)
      PRINT *, 'MY THREAD ID IS', ID
      CALL omp_unset_lock(LCK)
!$OMP END PARALLEL
      CALL omp_destroy_lock(LCK)
      END
```

## omp\_destroy\_nest\_lock(nvar)

### Purpose

The **omp\_destroy\_nest\_lock** subroutine initializes a nestable lock variable, causing the lock variable to become undefined. The variable *nvar* must be an unlocked and initialized nestable lock variable.

If you call **omp\_destroy\_nest\_lock** using an uninitialized variable, the result is undefined.

### Class

Subroutine.

### Argument Type and Attributes

**nvar**    Type integer with kind **omp\_nest\_lock\_kind**.

### Result Type and Attributes

None.

### Result Value

None.

## **omp\_get\_active\_level()**

### **Purpose**

The `omp_get_active_level` function returns the number of nested, active parallel regions.

### **Class**

Function.

### **Argument Type and Attributes**

None.

### **Result Type and Attributes**

Default integer.

### **Result Value**

An integer that indicates the number of nested, active parallel regions.

## **omp\_get\_ancestor\_thread\_num(level)**

### **Purpose**

The `omp_get_ancestor_thread_num` function returns the thread number of the ancestor at a given nested level of the current thread.

### **Class**

Function.

### **Argument Type and Attributes**

*level*

Default integer.

### **Result Type and Attributes**

Default integer.

### **Result Value**

The thread number of the ancestor at a given nested level ( *level* ) of the current thread. If *level* is outside the range of 0 and the nested level of the current thread, as returned by the `omp_get_level` routine, the function returns -1.

## **omp\_get\_dynamic()**

### **Purpose**

The `omp_get_dynamic` function returns `.TRUE.` if dynamic thread adjustment by the runtime environment is enabled. Otherwise, the `omp_get_dynamic` function returns `.FALSE.`

## **Class**

Function.

## **Argument Type and Attributes**

None.

## **Result Type and Attributes**

Default logical.

## **Result Value**

.TRUE. if dynamic thread adjustment by the runtime environment is enabled;  
.FALSE. otherwise.

## **omp\_get\_level()**

### **Purpose**

The `omp_get_level` function returns the number of nested parallel regions (both active and inactive).

## **Class**

Function.

## **Argument Type and Attributes**

None.

## **Result Type and Attributes**

Default integer.

## **Result Value**

The number of nested parallel regions (both active and inactive) in which the generating task is executing, not including the implicit parallel region. Returns 0 if it is called from the sequential part of the program. Otherwise, returns a nonnegative integer.

## **omp\_get\_max\_active\_levels()**

### **Purpose**

The `omp_get_max_active_levels` function returns the maximum number of nested, active parallel regions.

## **Class**

Function.

## **Argument Type and Attributes**

None.

## Result Type and Attributes

Default integer.

## Result Value

The maximum number of nested, active parallel regions that is allowed.

## **omp\_get\_max\_threads()**

### Purpose

The **omp\_get\_max\_threads** routine returns the first value of *num\_list* for the **OMP\_NUM\_THREADS** environment variable. This value is the maximum number of threads that can be used to form a new team if a parallel region without a **num\_threads** clause is encountered.

If you use **omp\_set\_num\_threads** to change the number of threads, subsequent calls to **omp\_get\_max\_threads** will return the new value.

The routine has global scope, which means that the maximum value it returns applies to all routines, subroutines, and compilation units in the program. It returns the same value whether executing from a serial or parallel region.

You can use **omp\_get\_max\_threads** to allocate maximum-sized data structures for each thread when you have enabled dynamic thread adjustment by passing **omp\_set\_dynamic** an argument which evaluates to **.TRUE**.

### Class

Function.

## Argument Type and Attributes

None.

## Result Type and Attributes

Default integer.

## Result Value

The maximum number of threads that can execute concurrently in a single parallel region.

## **omp\_get\_nested()**

### Purpose

The **omp\_get\_nested** function returns **.TRUE**, if nested parallelism is enabled and **.FALSE**, if nested parallelism is disabled.

### Class

Function

## Argument Type and Attributes

None.

## Result Type and Attributes

Default logical.

## Result Value

.TRUE. if nested parallelism is enabled. .FALSE. otherwise.

## **omp\_get\_num\_procs()**

### Purpose

The **omp\_get\_num\_procs** function returns the number of online processors on the machine.

### Class

Function.

## Argument Type and Attributes

None.

## Result Type and Attributes

Default integer.

## Result Value

The number of online processors on the machine.

## **omp\_get\_num\_threads()**

### Purpose

The **omp\_get\_num\_threads** function returns the number of threads in the team currently executing the parallel region from which it is called. The function binds to the closest enclosing **PARALLEL** directive.

The **omp\_set\_num\_threads** subroutine and the **OMP\_NUM\_THREADS** environment variable control the number of threads in a team. If you do not explicitly set the number of threads, the runtime environment will use the number of online processors on the machine by default. The number of online processors is less than or equal to the number of physical processors actually installed in a machine.

If you call **omp\_get\_num\_threads** from a serial portion of your program or from a nested parallel region that is serialized, the function returns 1.

### Class

Function.

## Argument Type and Attributes

None.

## Result Type and Attributes

Default integer.

## Result Value

The number of threads in the team currently executing the parallel region from which the function is called.

## Examples

```
USE omp_lib
INTEGER N1, N2

N1 = omp_get_num_threads()
PRINT *, N1
!$OMP PARALLEL PRIVATE(N2)
N2 = omp_get_num_threads()
PRINT *, N2
!$OMP END PARALLEL
END
```

The `omp_get_num_threads` call returns 1 in the serial section of the code, so N1 is assigned the value 1. N2 is assigned the number of threads in the team executing the parallel region, so the output of the second print statement will be an arbitrary number less than or equal to the value returned by `omp_get_max_threads`.

## `omp_get_schedule(kind, modifier)`

### Purpose

The `omp_get_schedule` subroutine returns the scheduling type that is applied when using the **runtime** schedule. The argument *kind* returns the type of schedule that is used. *modifier* represents the chunk size that is set for applicable schedule types.

### Class

Subroutine.

## Argument Type and Attributes

*kind*

Integer of kind `omp_sched_kind`. The value returned for *kind* is one of the following constants that are defined in `omp_lib` module:

- `omp_sched_static`
- `omp_sched_dynamic`
- `omp_sched_guided`
- `omp_sched_auto`
- `ibm_sched_affinity`

where `ibm_sched_affinity` is not part of the OpenMP specification.

**Note:** `ibm_sched_affinity` has been deprecated and might be removed in a future release. You can use `omp_sched_guided` for a similar functionality.

*modifier*

Default integer. For the schedule type **dynamic**, **guided**, or **static**, *modifier* is the chunk size that is set. For the schedule type **auto**, *modifier* has no meaning.

### **Result Type and Attributes**

None.

### **Result Value**

None.

## **omp\_get\_team\_size(level)**

### **Purpose**

The **omp\_get\_team\_size** function returns the size of the thread team that the ancestor belongs to.

### **Class**

Function.

### **Argument Type and Attributes**

*level*

Default integer. *level* is the nested level of the current thread.

### **Result Type and Attributes**

Default integer.

### **Result Value**

The size of the thread team that the ancestor belongs to. If *level* is outside of the range of 0 and the nested level of the current thread, as returned by the **omp\_get\_level** function, the function returns -1.

## **omp\_get\_thread\_limit()**

### **Purpose**

The **omp\_get\_thread\_limit** function returns the maximum number of OpenMP threads that are available to the program.

### **Class**

Function.

### **Argument Type and Attributes**

None.

### **Result Type and Attributes**

Default integer.



## Result Value

The maximum number of OpenMP threads that are available to the program.

## **omp\_get\_thread\_num()**

### Purpose

The **omp\_get\_thread\_num** function returns the number of the currently executing thread within the team. The number returned will always be between 0 and *NUM\_PARTHDS* - 1. *NUM\_PARTHDS* is the number of currently executing threads within the team. The master thread of the team returns a value of 0.

If you call **omp\_get\_thread\_num** from within a serial region, from within a serialized nested parallel region, or from outside the dynamic extent of any parallel region, this function will return a value of 0.

This function binds to the closest parallel region.

### Class

Function.

### Argument Type and Attributes

None.

### Result Type and Attributes

Default integer.

### Result Value

The value of the currently executing thread within the team between 0 and *NUM\_PARTHDS* - 1. *NUM\_PARTHDS* is the number of currently executing threads within the team. A call to **omp\_get\_thread\_num** from a serialized nested parallel region, or from outside the dynamic extent of any parallel region returns 0.

### Examples

The following example illustrates the return value of the **omp\_get\_thread\_num** routine in a PARALLEL region and a MASTER construct.

```
USE omp_lib
INTEGER NP
call omp_set_num_threads(4) ! 4 threads are used in the
                             ! parallel region

!$OMP PARALLEL PRIVATE(NP)
  NP = omp_get_thread_num()
  CALL WORK('in parallel', NP)
!$OMP MASTER
  NP = omp_get_thread_num()
  CALL WORK('in master', NP)
!$OMP END MASTER
!$OMP END PARALLEL
END
SUBROUTINE WORK(msg, THD_NUM)
```

```
INTEGER THD_NUM
character(*) msg
PRINT *, msg, THD_NUM
END
```

Output:

```
in parallel 1
in parallel 3
in parallel 2
in parallel 0
in master 0
```

(The order may be different.)

## **omp\_get\_wtick()**

### **Purpose**

The **omp\_get\_wtick** function returns a double precision value equal to the number of seconds between consecutive clock ticks.

### **Class**

Function.

### **Argument Type and Attributes**

None.

### **Result Type and Attributes**

Double precision real.

### **Result Value**

The number of seconds between consecutive ticks of the operating system real-time clock.

### **Examples**

```
USE omp_lib
DOUBLE PRECISION WTICKS
WTICKS = omp_get_wtick()
PRINT *, 'The clock ticks ', 10 / WTICKS, &
' times in 10 seconds.'
END
```

## **omp\_get\_wtime()**

### **Purpose**

The **omp\_get\_wtime** function returns a double precision value equal to the number of seconds since the initial value of the operating system real-time clock. The initial value is guaranteed not to change during execution of the program.

The value returned by the **omp\_get\_wtime** function is not consistent across all threads in the team.

## Class

Function.

## Argument Type and Attributes

None.

## Result Type and Attributes

Double precision real.

## Result Value

The number of seconds since the initial value of the operating system real-time clock.

## Examples

```
USE omp_lib
DOUBLE PRECISION START, END
START = omp_get_wtime()
! Work to be timed
END = omp_get_wtime()
PRINT *, 'Stuff took ', END - START, ' seconds.'
END
```

## omp\_in\_final()

### Purpose

The **omp\_in\_final** routine returns **.TRUE.** if the routine is called in a final task region. Otherwise, the routine returns **.FALSE.**

## Class

Function.

## Argument Type and Attributes

None.

## Result Type and Attributes

Default logical.

## Result Value

If the routine is called in a final task region, the result value is **.TRUE.**; otherwise, the result value is **.FALSE.**

## omp\_in\_parallel()

### Purpose

The **omp\_in\_parallel** function returns **.TRUE.** if you call it from the dynamic extent of a region executing in parallel and returns **.FALSE.** otherwise. If you call **omp\_in\_parallel** from a region that is serialized but nested within the dynamic extent of a region executing in parallel, the function will still return **.TRUE.**

(Nested parallel regions are serialized by default. See “omp\_set\_nested(enable\_expr)” on page 200 and the OMP\_NESTED environment variable for more information.)

## Class

Function.

## Argument Type and Attributes

None.

## Result Type and Attributes

Default logical.

## Result Value

**.TRUE.** if called from the dynamic extent of a region executing in parallel. **.FALSE.** otherwise.

## Examples

In the following example, the first call to **omp\_in\_parallel** returns **.FALSE.** because the call is outside the dynamic extent of any parallel region. The second call returns **.TRUE.**, even if the nested **PARALLEL DO** loop is serialized, because the call is still inside the dynamic extent of the outer **PARALLEL DO** loop.

```
USE omp_lib
INTEGER N, M
N = 4
M = 3
PRINT*, omp_in_parallel()
!$OMP PARALLEL DO
DO I = 1,N
!$OMP PARALLEL DO
DO J=1, M
PRINT *, omp_in_parallel()
END DO
!$OMP END PARALLEL DO
END DO
!$OMP END PARALLEL DO
END
```

## omp\_init\_lock(svar)

### Purpose

The **omp\_init\_lock** subroutine initializes a lock and associates it with the lock variable passed in as a parameter. After the call to **omp\_init\_lock**, the initial state of the lock variable is unlocked.

If you call this routine with a lock variable that you have already initialized, the result of the call is undefined.

## Class

Subroutine.

## Argument Type and Attributes

**svar** Integer of kind `omp_lock_kind`.

## Result Type and Attributes

None.

## Result Value

None.

## Examples

In the following example, threads and their associated tasks are generated by the parallel region, and one at a time, each task gains ownership of the lock associated with the lock variable `LCK`, prints the thread ID, and releases ownership of the lock.

```
USE omp_lib
INTEGER(kind=omp_lock_kind) LCK
INTEGER ID
CALL omp_init_lock(LCK)
!$OMP PARALLEL SHARED(LCK), PRIVATE(ID)
  ID = omp_get_thread_num()
  CALL omp_set_lock(LCK)
  PRINT *, 'MY THREAD ID IS', ID
  CALL omp_unset_lock(LCK)
!$OMP END PARALLEL
CALL omp_destroy_lock(LCK)
END
```

## `omp_init_nest_lock(nvar)`

### Purpose

The `omp_init_nest_lock` subroutine allows you to initialize a nestable lock and associate it with the lock variable you specify. The initial state of the lock variable is unlocked, and the initial nesting count is zero. The *nvar* must be an uninitialized nestable lock variable.

If you call `omp_init_nest_lock` using a variable that is already initialized, the result is undefined.

### Class

Subroutine.

## Argument Type and Attributes

**nvar** Integer of kind `omp_nest_lock_kind`.

## Result Type and Attributes

None.

## Result Value

None.

## Examples

The following example illustrates the use of a nestable lock for updating variable P in the PARALLEL SECTIONS construct.

```
USE omp_lib
INTEGER P
INTEGER A
INTEGER B
INTEGER ( kind=omp_nest_lock_kind ) LCK
CALL omp_init_nest_lock ( LCK ) ! initialize the nestable lock
!$OMP PARALLEL SECTIONS
!$OMP SECTION
CALL omp_set_nest_lock ( LCK )
P = P + A
CALL omp_set_nest_lock ( LCK )
P = P + B
CALL omp_unset_nest_lock ( LCK )
CALL omp_unset_nest_lock ( LCK )
!$OMP SECTION
CALL omp_set_nest_lock ( LCK )
P = P + B
CALL omp_unset_nest_lock ( LCK )
!$OMP END PARALLEL SECTIONS

CALL omp_destroy_nest_lock ( LCK )
END
```

## omp\_set\_dynamic(enable\_expr)

### Purpose

The **omp\_set\_dynamic** subroutine enables or disables dynamic adjustment, by the runtime environment, of the number of threads available to execute parallel regions.

If **enable\_expr** is evaluated to **.TRUE.**, the runtime environment can automatically adjust the number of threads that are used to execute subsequent parallel regions to obtain the best use of system resources. The number of threads you specify using **omp\_set\_num\_threads** becomes the maximum, not exact, thread count.

If **enable\_expr** is evaluated to **.FALSE.**, dynamic adjustment of the number of threads is disabled. The runtime environment cannot automatically adjust the number of threads used to execute subsequent parallel regions. The value you pass to **omp\_set\_num\_threads** becomes the exact thread count.

By default, dynamic thread adjustment is disabled. If your code depends on a specific number of threads for correct execution, you should explicitly disable dynamic threads.

If the routine is called from a portion of the program where the **omp\_in\_parallel** routine returns **.TRUE.**, the routine has no effect.

This subroutine has precedence over the **OMP\_DYNAMIC** environment variable.

### Class

Subroutine.

## Argument Type and Attributes

`enable_expr`

Logical.

## Result Type and Attributes

None.

## Result Value

None.

## `omp_set_lock(svar)`

### Purpose

The `omp_set_lock` subroutine forces the calling task region to wait until the specified lock is available before executing subsequent instructions. The calling task region is given ownership of the lock when it becomes available.

If you call this routine with an uninitialized lock variable, the result of the call is undefined. If a task region that owns a lock tries to lock it again by issuing a call to `omp_set_lock`, the call produces a deadlock.

### Class

Subroutine.

## Argument Type and Attributes

`svar` Integer of kind `omp_lock_kind`.

## Result Type and Attributes

None.

## Result Value

None.

## Examples

In the following example, the lock variable `LCK_X` is used to avoid race conditions when updating the shared variable `X`. By setting the lock before each update to `X` and unsetting it after the update, you ensure that only one task region updates `X` at a given time.

```
USE omp_lib
INTEGER A(100), X
INTEGER(kind=omp_lock_kind) LCK_X
X=1
CALL omp_init_lock (LCK_X)
!$OMP PARALLEL PRIVATE (I), SHARED (A, X)
!$OMP DO
DO I = 3, 100
  A(I) = I * 10
  CALL omp_set_lock (LCK_X)
  X = X + A(I)
  CALL omp_unset_lock (LCK_X)
```

```
        END DO
!$OMP END DO
!$OMP END PARALLEL
        CALL omp_destroy_lock (LCK_X)
        END
```

## **omp\_set\_max\_active\_levels(max\_levels)**

### **Purpose**

The **omp\_set\_max\_active\_levels** subroutine limits the number of nested, active parallel regions. Use **omp\_set\_max\_active\_levels** only in serial regions of a program. This routine has no effect in parallel regions of a program.

### **Class**

Subroutine.

### **Argument Type and Attributes**

*max\_levels*  
Default integer.

### **Result Type and Attributes**

None.

### **Result Value**

None.

## **omp\_set\_nested(enable\_expr)**

### **Purpose**

The **omp\_set\_nested** subroutine enables or disables nested parallelism.

If **enable\_expr** is evaluated to **.FALSE.**, nested parallelism is disabled. Nested parallel regions are serialized, and they are executed by the current thread. This is the default setting.

If **enable\_expr** is evaluated to **.TRUE.**, nested parallelism is enabled. Parallel regions that are nested can deploy additional threads to the team. It is up to the runtime environment to determine whether additional threads should be deployed. Therefore, the number of threads used to execute parallel regions may vary from one nested region to the next.

If the routine is called from a portion of the program where the **omp\_in\_parallel** routine returns true, the routine has no effect.

The setting of the **omp\_set\_nested** subroutine overrides the setting of the **OMP\_NESTED** environment variable.

**Note:** If the number of threads from all regions exceeds the number of available processors, your program might suffer performance degradation.



## Class

Subroutine.

## Argument Type and Attributes

`enable_expr`

Logical.

## Result Type and Attributes

Default logical.

## Result Value

None.

## `omp_set_nest_lock(nvar)`

### Purpose

The `omp_set_nest_lock` subroutine allows you to set a nestable lock. The task region executing the subroutine will wait until the lock becomes available and then set that lock, incrementing the nesting count. A nestable lock is available if it is owned by the task region executing the subroutine, or is unlocked.

## Class

Subroutine.

## Argument Type and Attributes

`nvar` Integer of kind `omp_nest_lock_kind`.

## Result Type and Attributes

None.

## Result Value

None.

## Examples

```
USE omp_lib
INTEGER P
INTEGER A
INTEGER B
INTEGER ( kind=omp_nest_lock_kind ) LCK

CALL omp_init_nest_lock ( LCK )

!$OMP PARALLEL SECTIONS
!$OMP SECTION
CALL omp_set_nest_lock ( LCK )
P = P + A
CALL omp_set_nest_lock ( LCK )
P = P + B
CALL omp_unset_nest_lock ( LCK )
CALL omp_unset_nest_lock ( LCK )
!$OMP SECTION
```

```

CALL omp_set_nest_lock ( LCK )
P = P + B
CALL omp_unset_nest_lock ( LCK )
!$OMP END PARALLEL SECTIONS

CALL omp_destroy_nest_lock ( LCK )
END

```

## omp\_set\_num\_threads(number\_of\_threads\_expr)

### Purpose

The **omp\_set\_num\_threads** routine specifies the number of threads to use for the next parallel region by setting the first value of *num\_list* for the **OMP\_NUM\_THREADS** environment variable.

The **number\_of\_threads\_expr** argument is evaluated, and its value is used as the number of threads. If you have enabled dynamic adjustment of the number of threads (see “omp\_set\_dynamic(enable\_expr)” on page 198), **omp\_set\_num\_threads** sets the maximum number of threads to use for the next parallel region. The runtime environment then determines the exact number of threads to use. However, when dynamic adjustment of the number of threads is disabled, **omp\_set\_num\_threads** sets the exact number of threads to use in the next parallel region. If the number of threads you request exceeds the number your execution environment can support, your application will terminate.

This subroutine takes precedence over the **OMP\_NUM\_THREADS** environment variable.

If you call this subroutine from the dynamic extent of a region executing in parallel, the behavior of the subroutine is undefined.

### Class

Subroutine.

### Argument Type and Attributes

**number\_of\_threads\_expr**  
integer

### Result Type and Attributes

None.

### Result Value

None.

## omp\_set\_schedule(kind, modifier)

### Purpose

The **omp\_set\_schedule** routine affects the schedule that is applied when **runtime** is used as schedule kind. Use **omp\_set\_schedule** if you want to set the schedule type separately from the *OMP\_SCHEDULE* environment variable.

**Note:** You can use the **omp\_get\_schedule** to return scheduling type. For details, see *omp\_get\_schedule* .

## Class

Subroutine.

## Argument Type and Attributes

*kind*

Type integer with kind **omp\_sched\_kind**. Must be one of the schedule types as represented by the following constants:

- **omp\_sched\_static**
- **omp\_sched\_dynamic**
- **omp\_sched\_guided**
- **omp\_sched\_auto**
- **ibm\_sched\_affinity**

where **ibm\_sched\_affinity** is not part of the OpenMP.

**Note:** **ibm\_sched\_affinity** has been deprecated and might be removed in a future release. You can use **omp\_sched\_guided** for a similar functionality.

*modifier*

Default integer. For the schedule type **dynamic**, **guided**, or **static**, *modifier* is the chunk size that you want to set. Typically, it is a positive integer. If the value is less than one, the default is used. For the schedule type **auto**, *modifier* has no meaning. For the default setting of each schedule type, see `-qsmp` in the *XL Fortran Compiler Reference*.

## Result Type and Attributes

None.

## Result Value

None.

## **omp\_test\_lock(svar)**

### Purpose

The **omp\_test\_lock** function attempts to set the lock associated with the specified lock variable. It returns **.TRUE.** if it was able to set the lock and **.FALSE.** otherwise. In either case, the calling task region will continue to execute subsequent instructions in the program.

If you call **omp\_test\_lock** with an uninitialized lock variable, the result of the call is undefined.

## Class

Function.

## Argument Type and Attributes

**svar** Integer of kind **omp\_lock\_kind**.

## Result Type and Attributes

Default logical.

## Result Value

**.TRUE.** if the function was able to set the lock. **.FALSE.** otherwise.

## Examples

In the following example, a task region repeatedly executes `WORK_A` until it can set the lock variable, `LCK`. When the lock is set, the task region executes `WORK_B`.

```
USE omp_lib
INTEGER LCK
INTEGER ID
CALL omp_init_lock (LCK)
!$OMP PARALLEL SHARED(LCK), PRIVATE(ID)
  ID = omp_get_thread_num()
  DO WHILE (.NOT. omp_test_lock(LCK))
    CALL WORK_A (ID)
  END DO
  CALL WORK_B (ID)
  CALL omp_unset_lock (LCK)
!$OMP END PARALLEL
CALL omp_destroy_lock (LCK)
END
```

## `omp_test_nest_lock(nvar)`

### Purpose

The `omp_test_nest_lock` subroutine allows you to attempt to set a lock using the same method as `omp_set_nest_lock`, but the executing task region does not wait for confirmation that the lock is available. If the lock is successfully set, the function will increment the nesting count and return the new nesting count. If the lock is unavailable the function returns a value of zero. Also, a child task sees a value of zero if the parent task has already set the same lock. The result value is always a default integer.

### Class

Function.

### Argument Type and Attributes

`nvar` Integer of kind `omp_nest_lock_kind`.

### Result Type and Attributes

Default integer.

### Result Value

The new nesting count if the lock is successfully set; otherwise, it returns zero.

## omp\_unset\_lock(svar)

### Purpose

The **omp\_unset\_lock** subroutine causes the executing task region to release ownership of the specified lock. The lock can then be set by another task region as required. The behavior of the **omp\_unset\_lock** subroutine is undefined if either of the following conditions occur:

- The calling task region does not own the lock specified.
- The routine is called with an uninitialized lock variable.

### Class

Subroutine.

### Argument Type and Attributes

**svar** Integer of kind **omp\_lock\_kind**.

### Result Type and Attributes

None.

### Result Value

None.

### Examples

```
USE omp_lib
INTEGER A(100)
INTEGER(kind=omp_lock_kind) LCK_X
CALL omp_init_lock (LCK_X)
!$OMP PARALLEL PRIVATE (I), SHARED (A, X)
!$OMP DO
DO I = 3, 100
  A(I) = I * 10
  CALL omp_set_lock (LCK_X)
  X = X + A(I)
  CALL omp_unset_lock (LCK_X)
END DO
!$OMP END DO
!$OMP END PARALLEL
CALL omp_destroy_lock (LCK_X)
END
```

In this example, the lock variable **LCK\_X** is used to avoid race conditions when updating the shared variable **X**. By setting the lock before each update to **X** and unsetting it after the update, you ensure that only one task region is updating **X** at a given time.

## omp\_unset\_nest\_lock(nvar)

### Purpose

The **omp\_unset\_nest\_lock** subroutine allows you to release ownership of a nestable lock. The subroutine decrements the nesting count and releases the associated task region from ownership of the nestable lock.

## Class

Subroutine.

## Argument Type and Attributes

`nvar` Integer of kind `omp_lock_kind`.

## Result Type and Attributes

None.

## Result Value

None.

## Examples

```
USE omp_lib
INTEGER P
INTEGER A
INTEGER B
INTEGER ( kind=omp_nest_lock_kind ) LCK

CALL omp_init_nest_lock ( LCK )

!$OMP PARALLEL SECTIONS
!$OMP SECTION
CALL omp_set_nest_lock ( LCK )
P = P + A
CALL omp_set_nest_lock ( LCK )
P = P + B
CALL omp_unset_nest_lock ( LCK )
CALL omp_unset_nest_lock ( LCK )
!$OMP SECTION
CALL omp_set_nest_lock ( LCK )
P = P + B
CALL omp_unset_nest_lock ( LCK )
!$OMP END PARALLEL SECTIONS

CALL omp_destroy_nest_lock ( LCK )
END
```

---

## Pthreads Library Module

The Pthreads Library Module (**f\_pthread**) is a Fortran 90 module that defines data types and routines to make it easier to interface with the AIX pthreads library. The AIX pthreads library is used to parallelize and to make your code thread-safe.

The **f\_pthread** library module naming convention is the use of the prefix **f\_** before the corresponding AIX pthreads library routine name or type definition name.

AIX supports both the default POSIX 1003.1-1996 standard, and the Draft 7 POSIX pthreads API. Depending on which invocation command you use, you can compile and link your programs with either the POSIX 1003.1-1996 standard, or the Draft 7 interface libraries. For more information about how to do this, see *Levels of POSIX pthreads API support, Linking 32-bit* and *Linking 64-bit SMP object files* in the *XL Fortran Compiler Reference*.

In general, there is a one-to-one corresponding relationship between the procedures in the Fortran 90 module **f\_pthread** and the library routines contained in the AIX

pthread library. However, some of the pthread routines have no corresponding procedures in this module because they are not supported on AIX. One example of these routines is the thread stack address option. There are also some non-pthread interfacing routines contained in the `f_pthread` library module. The `f_maketime` routine is one example and is included to return an absolute time in a `f_timespec` derived type variable.

Most of the routines return an integer value. A return value of 0 will always indicate that the routine call did not result in any error. Any non-zero return value indicates an error. Each error code has a corresponding definition of a system error code in Fortran. These error codes are available as Fortran integer constants. The naming of these error codes in Fortran is consistent with the corresponding AIX error code names. For example, `EINVAL` is the Fortran constant name of the error code `EINVAL` on the system. For a complete list of these error codes, refer to the file `/usr/include/sys/errno.h`.

For more information about the system calls corresponding to the Fortran Pthreads library calls, see the AIX Operating System information.

**Note:** The pthread module in XL Fortran is an extension to the standard Fortran language.

## Pthreads data structures, functions, and subroutines

### Pthreads data types

- `f_pthread_attr_t`
- `f_pthread_cond_t`
- `f_pthread_condattr_t`
- `f_pthread_key_t`
- `f_pthread_mutex_t`
- `f_pthread_mutexattr_t`
- `f_pthread_once_t`
- `f_pthread_rwlock_t`
- `f_pthread_rwlockattr_t`
- `f_pthread_t`
- `f_sched_param`
- `f_timespec`

### Functions that perform operations on thread attribute objects

- `f_pthread_attr_destroy(attr)`
- `f_pthread_attr_getdetachstate(attr, detach)`
- `f_pthread_attr_getguardsize(attr, guardsize)`
- `f_pthread_attr_getinheritsched(attr, inherit)`
- `f_pthread_attr_getschedparam(attr, param)`
- `f_pthread_attr_getschedpolicy(attr, policy)`
- `f_pthread_attr_getscope(attr, scope)`
- `f_pthread_attr_getstackaddr(attr, stackaddr)`
- `f_pthread_attr_getstacksize(attr, ssize)`
- `f_pthread_attr_init(attr)`
- `f_pthread_attr_setdetachstate(attr, detach)`

- `f_thread_attr_setguardsize(attr, guardsize)`
- `f_thread_attr_setinheritsched(attr, inherit)`
- `f_thread_attr_setschedparam(attr, param)`
- `f_thread_attr_setschedpolicy(attr, policy)`
- `f_thread_attr_setscope(attr, scope)`
- `f_thread_attr_setstackaddr(attr, stackaddr)`
- `f_thread_attr_setstacksize(attr, ssize)`

### **Functions and subroutines that perform operations on threads**

- `f_thread_cancel(thread)`
- `f_thread_cleanup_pop(exec)`
- `f_thread_cleanup_push(cleanup, flag, arg)`
- `f_thread_create(thread, attr, flag, ent, arg)`
- `f_thread_detach(thread)`
- `f_thread_equal(thread1, thread2)`
- `f_thread_exit(ret)`
- `f_thread_getconcurrency()`
- `f_thread_getschedparam(thread, policy, param)`
- `f_thread_join(thread, ret)`
- `f_thread_kill(thread, sig)`
- `f_thread_self()`
- `f_thread_setconcurrency(new_level)`
- `f_thread_setschedparam(thread, policy, param)`

### **Functions that perform operations on mutex attribute objects**

- `f_thread_mutexattr_destroy(mattr)`
- `f_thread_mutexattr_getprioceiling(mattr, ceiling)`
- `f_thread_mutexattr_getprotocol(mattr, proto)`
- `f_thread_mutexattr_getpshared(mattr, pshared)`
- `f_thread_mutexattr_gettype(mattr, type)`
- `f_thread_mutexattr_init(mattr)`
- `f_thread_mutexattr_setprioceiling(mattr, ceiling)`
- `f_thread_mutexattr_setprotocol(mattr, proto)`
- `f_thread_mutexattr_setpshared(mattr, pshared)`
- `f_thread_mutexattr_settype(mattr, type)`

### **Functions that perform operations on mutex objects**

- `f_thread_mutex_destroy(mutex)`
- `f_thread_mutex_getprioceiling(mutex, old)`
- `f_thread_mutex_init(mutex, mattr)`
- `f_thread_mutex_lock(mutex)`
- `f_thread_mutex_setprioceiling(mutex, new, old)`
- `f_thread_mutex_trylock(mutex)`
- `f_thread_mutex_unlock(mutex)`



### **Functions that perform operations on attribute objects of condition variables**

- `f_pthread_condattr_destroy(cattr)`
- `f_pthread_condattr_getpshared(cattr, pshared)`
- `f_pthread_condattr_init(cattr)`
- `f_pthread_condattr_setpshared(cattr, pshared)`

### **Functions that perform operations on condition variable objects**

- `f_maketime(delay)`
- `f_pthread_cond_broadcast(cond)`
- `f_pthread_cond_destroy(cond)`
- `f_pthread_cond_init(cond, cattr)`
- `f_pthread_cond_signal(cond)`
- `f_pthread_cond_timedwait(cond, mutex, timeout)`
- `f_pthread_cond_wait(cond, mutex)`

### **Functions that perform operations on thread-specific data**

- `f_pthread_getspecific(key, arg)`
- `f_pthread_key_create(key, dtr)`
- `f_pthread_key_delete(key)`
- `f_pthread_setspecific(key, arg)`

### **Functions and subroutines that perform operations to control thread cancelability**

- `f_pthread_setcancelstate(state, oldstate)`
- `f_pthread_setcanceltype(type, oldtype)`
- `f_pthread_testcancel()`

### **Functions that perform operations on read-write lock attribute objects**

- `f_pthread_rwlockattr_destroy(rwattr)`
- `f_pthread_rwlockattr_getpshared(rwattr, pshared)`
- `f_pthread_rwlockattr_init(rwattr)`
- `f_pthread_rwlockattr_setpshared(rwattr, pshared)`

### **Functions that perform operations on read-write lock objects**

- `f_pthread_rwlock_destroy(rwlock)`
- `f_pthread_rwlock_init(rwlock, rwattr)`
- `f_pthread_rwlock_rdlock(rwlock)`
- `f_pthread_rwlock_tryrdlock(rwlock)`
- `f_pthread_rwlock_trywrlock(rwlock)`
- `f_pthread_rwlock_unlock(rwlock)`
- `f_pthread_rwlock_wrlock(rwlock)`

### **Functions that perform operations for one-time initialization**

- `f_pthread_once(once, initr)`

## **f\_maketime(delay)**

### **Purpose**

This function accepts an integer value specifying a delay in seconds and returns an `f_timespec` type object containing the absolute time, which is `delay` seconds from the calling moment.

### **Class**

Function

### **Argument Type and Attributes**

`delay` INTEGER(4), INTENT(IN)

### **Result Type and Attributes**

TYPE (`f_timespec`)

### **Result Value**

The absolute time, which is `delay` seconds from the calling moment, is returned.

## **f\_pthread\_attr\_destroy(attr)**

### **Purpose**

This function must be called to destroy any previously initialized thread attribute objects when they will no longer be used. Threads that were created with this attribute object will not be affected in any way by this action. Memory that was allocated when it was initialized will be reclaimed by the system.

### **Class**

Function

### **Argument Type and Attributes**

`attr` TYPE(`f_pthread_attr_t`), INTENT(IN)

### **Result Type and Attributes**

INTEGER(4)

### **Result Value**

On successful completion, this function returns 0. Otherwise, this function returns the following error.

#### **EINVAL**

The argument `attr` is invalid.

## **f\_thread\_attr\_getdetachstate(attr, detach)**

### **Purpose**

This function can be used to query the setting of the detach state attribute in the thread attribute object *attr*. The current setting will be returned through argument *detach*.

### **Class**

Function

### **Argument Type and Attributes**

*attr* TYPE(f\_thread\_attr\_t), INTENT(IN)

*detach* INTEGER(4), INTENT(OUT)

Contains one of the following values:

#### **PTHREAD\_CREATE\_DETACHED:**

when a thread attribute object of this attribute setting is used to create a new thread, the newly created thread will be in detached state.

#### **PTHREAD\_CREATE\_UNDETACHED:**

#### **PTHREAD\_CREATE\_JOINABLE:**

when a thread attribute object of this attribute setting is used to create a new thread, the newly created thread will be in undetached state. This is the system default.

For more information about these thread states, refer to the AIX Operating System information.

### **Result Type and Attributes**

INTEGER(4)

### **Result Value**

On successful completion, this function returns 0. Otherwise, this function returns the following error:

**EINVAL**

The argument *attr* is invalid.

## **f\_thread\_attr\_getguardsize(attr, guardsize)**

### **Purpose**

This function is used to get the *guardsize* attribute in the thread attribute object *attr*. The current setting of the attribute will be returned through the argument *guardsize*.

### **Class**

Function

## Argument Type and Attributes

**attr** TYPE(f\_thread\_attr\_t), INTENT(IN)

**guardsize**

INTEGER(KIND=register\_size), INTENT(IN)

where *register\_size* is 4 in 32-bit mode, and 8 in 64-bit mode.

## Result Type and Attributes

INTEGER(4)

## Result Value

On successful completion, this function returns 0. Otherwise, this function returns the following error:

**EINVAL**

The argument *attr* is invalid.

## f\_thread\_attr\_getinheritsched(attr, inherit)

### Purpose

This function can be used to query the inheritance scheduling attribute in the thread attribute object *attr*. The current setting will be returned through the argument *inherit*.

### Class

Function

## Argument Type and Attributes

**attr** TYPE(f\_thread\_attr\_t), INTENT(OUT)

**inherit**

INTEGER(4)

On return from the function, *inherit* contains one of the following values:

### **PTHREAD\_INHERIT\_SCHED:**

indicating that newly created threads will inherit the scheduling property of the parent thread and ignore the scheduling property of the thread attribute object used to create them.

### **PTHREAD\_EXPLICIT\_SCHED:**

the scheduling property in the thread attribute object will be assigned to the newly created threads when it is used to create them.

## Result Type and Attributes

INTEGER(4)

## Result Value

On successful completion, this function returns 0. Otherwise, this function returns the following error.

**EINVAL**

The argument **attr** is invalid.

**ENOSYS**

The POSIX priority scheduling option is not implemented on AIX

## **f\_pthread\_attr\_getschedparam(attr, param)**

### **Purpose**

This function can be used to query the scheduling property setting in the thread attribute object **attr**. The current setting will be returned in the argument **param**. See the AIX system information for a description of the scheduling property setting.

### **Class**

Function

### **Argument Type and Attributes**

**attr** TYPE(f\_pthread\_attr\_t), INTENT(IN)

**param** TYPE(f\_sched\_param), INTENT(OUT)

### **Result Type and Attributes**

INTEGER(4)

### **Result Value**

On successful completion, this function returns 0. Otherwise, this function returns one of the following errors.

**EINVAL**

The argument **attr** is invalid.

**ENOSYS**

The POSIX priority scheduling option is not implemented on AIX.

## **f\_pthread\_attr\_getschedpolicy(attr, policy)**

### **Purpose**

This function can be used to query the scheduling policy attribute setting in the attribute object **attr**. The current setting of the scheduling policy will be returned in the argument **policy**. The valid scheduling policies on AIX can be found in the AIX Operating System information.

### **Class**

Function

### **Argument Type and Attributes**

**attr** TYPE(f\_pthread\_attr\_t), INTENT(IN)

**policy** INTEGER(4), INTENT(OUT)

## Result Type and Attributes

INTEGER(4)

## Result Value

On successful completion, this function returns 0. Otherwise, this function returns one of the following errors.

**EINVAL**

The argument **attr** is invalid.

**ENOSYS**

The POSIX priority scheduling option is not implemented on AIX.

## **f\_pthread\_attr\_getscope(attr, scope)**

### Purpose

This function can be used to query the current setting of the scheduling scope attribute in the thread attribute object **attr**. The current setting will be returned through the argument **scope**.

### Class

Function

### Argument Type and Attributes

**attr** TYPE(f\_pthread\_attr\_t), INTENT(IN)

**scope** INTEGER(4), INTENT(OUT)

On return from the function, **scope** will contain one of the following values:

**PTHREAD\_SCOPE\_SYSTEM:**

the thread will compete for system resources on a system wide scope.

**PTHREAD\_SCOPE\_PROCESS:**

the thread will compete for system resources locally within the owning process.

## Result Type and Attributes

INTEGER(4)

## Result Value

On successful completion, this function returns 0. Otherwise, this function returns one of the following errors.

**EINVAL**

The argument **attr** is invalid.

**ENOSYS**

The POSIX priority scheduling option is not implemented on AIX.

## **f\_thread\_attr\_getstackaddr(attr, stackaddr)**

### **Purpose**

This function is used to get the *stackaddr* attribute in the thread attribute object *attr*. The current setting of the attribute will be returned through the argument *stackaddr*. The type of the argument *stackaddr* is Integer pointer. The *stackaddr* attribute specifies the stack address of a thread created with this attributes object.

### **Class**

Function

### **Argument Type and Attributes**

**attr** TYPE(f\_thread\_attr\_t), INTENT(OUT)

**stackaddr**  
Integer pointer, INTENT(OUT)

**ssize** INTEGER(KIND=register\_size), INTENT(OUT)  
where *register\_size* is 4 in 32-bit mode, and 8 in 64-bit mode.

### **Result Type and Attributes**

INTEGER(4)

### **Result Value**

On successful completion, this function returns 0. Otherwise, this function returns the following error.

**EINVAL**  
The argument **attr** is invalid.

## **f\_thread\_attr\_getstacksize(attr, ssize)**

### **Purpose**

This function can be used to query the current stack size attribute setting in the attribute object **attr**. If this function executes successfully, the stack size in bytes will be returned in argument **ssize**.

### **Class**

Function

### **Argument Type and Attributes**

**attr** TYPE(f\_thread\_attr\_t), INTENT(IN)

**ssize** INTEGER(KIND=register\_size), INTENT(OUT)  
where *register\_size* is 4 in 32-bit mode, and 8 in 64-bit mode.

### **Result Type and Attributes**

INTEGER(4)

## Result Value

On successful completion, this function returns 0. Otherwise, this function returns one of the following errors.

### EINVAL

The argument `attr` is invalid.

### ENOSYS

The POSIX stack size option is not implemented on AIX

## **f\_thread\_attr\_init(attr)**

### Purpose

This function must be called to create and initialize the pthread attribute object `attr` before it can be used in any way. It will be filled with system default thread attribute values. After it is initialized, certain pthread attributes can be changed and/or set through attribute access procedures. Once initialized, this attribute object can be used to create a thread with the intended attributes. Refer to the AIX Operating System information for descriptions of the default attributes.

### Class

Function

### Argument Type and Attributes

`attr`    TYPE(f\_thread\_attr\_t), INTENT(OUT)

### Result Type and Attributes

INTEGER(4)

### Result Value

On successful completion, this function returns 0. Otherwise, this function returns one of the following errors.

### EINVAL

The argument `attr` is invalid.

### ENOMEM

There is insufficient memory to create this attribute object.

## **f\_thread\_attr\_setdetachstate(attr, detach)**

### Purpose

This function can be used to set the detach state attribute in the thread attribute object `attr`.

For descriptions of these thread states, refer to the AIX Operating System information.

### Class

Function



## Argument Type and Attributes

**attr** TYPE(f\_thread\_attr\_t), INTENT(OUT)

**detach** INTEGER(4), INTENT(IN)

Must contain one of the following values:

### PTHREAD\_CREATE\_DETACHED:

when a thread attribute object of this attribute setting is used to create a new thread, the newly created thread will be in detached state. This is the system default setting.

### PTHREAD\_CREATE\_UNDETACHED:

when a thread attribute object of this attribute setting is used to create a new thread, the newly created thread will be in undetached state.

## Result Type and Attributes

INTEGER(4)

## Result Value

On successful completion, this function returns 0. Otherwise, this function returns the following error.

EINVAL

The argument **attr** or **detach** is invalid.

## f\_thread\_attr\_setguardsize(attr, guardsize)

### Purpose

This function is used to set the **guardsize** attribute in the thread attributes object **attr**. The new value of this attribute is obtained from the argument **guardsize**. If **guardsize** is zero, a guard area will not be provided for threads created with **attr**. If **guardsize** is greater than zero, a guard area of at least size **guardsize** bytes is provided for each thread created with **attr**.

For a description of **guardsize**, refer to the AIX Operating System information.

### Class

Function

## Argument Type and Attributes

**attr** TYPE(f\_thread\_attr\_t), INTENT(INOUT)

**guardsize**

INTEGER(KIND=register\_size), INTENT(IN)

where *register\_size* is 4 in 32-bit mode, and 8 in 64-bit mode.

## Result Type and Attributes

INTEGER(4)

## Result Value

On successful completion, this function returns 0. Otherwise, this function returns the following error.

### EINVAL

The argument **attr** or the argument **guardsize** is invalid.

## **f\_thread\_attr\_setinheritsched(attr, inherit)**

### Purpose

This function can be used to set the inheritance attribute of the thread scheduling property in the thread attribute object **attr**.

### Class

Function

### Argument Type and Attributes

**attr** TYPE(f\_thread\_attr\_t), INTENT(OUT)

**inherit**

INTEGER(4), INTENT(IN)

Must contain one of the following values:

#### **PTHREAD\_INHERIT\_SCHED:**

indicating that newly created threads will inherit the scheduling property of the parent thread and ignore the scheduling property of the thread attribute object used to create them.

#### **PTHREAD\_EXPLICIT\_SCHED:**

the scheduling property in the thread attribute object will be assigned to the newly created threads when it is used to create them.

### Result Type and Attributes

INTEGER(4)

## Result Value

On successful completion, this function returns 0. Otherwise, this function returns one of the following errors.

### EINVAL

The argument **attr** is invalid.

### ENOSYS

The POSIX priority scheduling option is not implemented on AIX.

### ENOTSUP

The value of argument **inherit** is not supported.

## **f\_pthread\_attr\_setschedparam(attr, param)**

### **Purpose**

This function can be used to set the scheduling property attribute in the thread attribute object **attr**. Threads created with this new attribute object will assume the scheduling property of argument **param** if they are not inherited from the creating thread. The `sched_priority` field in argument **param** indicates the thread's scheduling priority. The priority field must assume a value in the range of 1-127, where 127 is the most favored scheduling priority while 1 is the least.

### **Class**

Function

### **Argument Type and Attributes**

**attr** TYPE(f\_pthread\_attr\_t), INTENT(INOUT)

**param** TYPE(f\_sched\_param), INTENT(IN)

### **Result Type and Attributes**

INTEGER(4)

### **Result Value**

On successful completion, this function returns 0. Otherwise, this function returns one of the following errors.

**EINVAL**

The argument **attr** is invalid.

**ENOSYS**

The POSIX priority scheduling option is not implemented on AIX.

**ENOTSUP**

The value of argument **param** is not supported.

## **f\_pthread\_attr\_setschedpolicy(attr, policy)**

### **Purpose**

After the attribute object is set by this function, threads created with this attribute object will assume the set scheduling policy if the scheduling property is not inherited from the creating thread.

### **Class**

Function

### **Argument Type and Attributes**

**attr** TYPE(f\_pthread\_attr\_t), INTENT(INOUT)

**policy** INTEGER(4), INTENT(IN)

Must contain one of the following values:

**SCHED\_FIFO:**

indicating a first-in first-out thread scheduling policy.

**SCHED\_RR:**

indicating a round-robin scheduling policy.

**SCHED\_OTHER:**

the default scheduling policy.

## Result Type and Attributes

INTEGER(4)

## Result Value

On successful completion, this function returns 0. Otherwise, this function returns one of the following errors.

**EINVAL**

The argument **attr** is invalid.

**ENOSYS**

The POSIX priority scheduling option is not implemented on AIX.

**ENOTSUP**

The value of argument **policy** is not supported.

## **f\_thread\_attr\_setscope(attr, scope)**

### Purpose

This function can be used to set the contention scope attribute in the thread attribute object **attr**.

### Class

Function

### Argument Type and Attributes

**attr** TYPE(f\_thread\_attr\_t), INTENT(INOUT)

**scope** INTEGER(4), INTENT(IN)

Must contain one of the following values:

**PTHREAD\_SCOPE\_SYSTEM:**

the thread will compete for system resources on a system wide scope.

**PTHREAD\_SCOPE\_PROCESS:**

the thread will compete for system resources locally within the owning process.

## Result Type and Attributes

INTEGER(4)

## Result Value

On successful completion, this function returns 0. Otherwise, this function returns one of the following errors.

EINVAL

The argument `attr` is invalid.

ENOTSUP

ENOTSUP is returned if the specified `scope` is `PTHREAD_SCOPE_PROCESS`.

## **f\_thread\_attr\_setstackaddr(attr, stackaddr)**

### **Purpose**

This function is used to set the `stackaddr` attribute in the thread attributes object `attr`. The new value of this attribute is obtained from the argument `stackaddr`. The type of the argument `stackaddr` is Integer pointer. The `stackaddr` attribute specifies the stack address of a thread created with this attributes object.

### **Class**

Function

### **Argument Type and Attributes**

`attr` TYPE(f\_thread\_attr\_t), INTENT(INOUT)

`stackaddr`

Integer pointer, INTENT(IN)

### **Result Type and Attributes**

INTEGER(4)

### **Result Value**

On successful completion, this function returns 0. Otherwise, this function returns the following error.

EINVAL

The argument `attr` is invalid.

## **f\_thread\_attr\_setstacksize(attr, ssize)**

### **Purpose**

This function can be used to set the stack size attribute in the pthread attribute object `attr`. Argument `ssize` is an integer indicating the desired stack size in bytes. When a thread is created using this attribute object, the system will allocate a minimum stack size of `ssize` bytes.

### **Class**

Function

### **Argument Type and Attributes**

`attr` TYPE(f\_thread\_attr\_t), INTENT(INOUT)

`ssize` INTEGER(KIND=register\_size), INTENT(IN)

where `register_size` is 4 in 32-bit mode, and 8 in 64-bit mode.

## Result Type and Attributes

INTEGER(4)

## Result Value

On successful completion, this function returns 0. Otherwise, this function returns one of the following errors.

EINVAL

The argument **attr** or **ssize** is invalid.

ENOSYS

The POSIX stack size option is not implemented on AIX.

## f\_pthread\_attr\_t

### Purpose

A derived data type whose components are all private. Any object of this type should be manipulated only through the appropriate interfaces provided in this module.

This data type corresponds to the POSIX **pthread\_attr\_t**, which is the type of thread attribute object.

### Class

Data Type.

## f\_pthread\_cancel(thread)

### Purpose

This function can be used to cancel a target thread. How this cancellation request will be processed depends on the state of the cancelability of the target thread. The target thread is identified by argument **thread**. If the target thread is in deferred-cancel state, this cancellation request will be put on hold until the target thread reaches its next cancellation point. If the target thread disables its cancelability, this request will be put on hold until it is enabled again. If the target thread is in async-cancel state, this request will be acted upon immediately. For further details about thread cancellation and concerns about security, refer to the AIX Operating System information.

### Class

Function

### Argument Type and Attributes

**thread** TYPE(f\_pthread\_t), INTENT(INOUT)

### Result Type and Attributes

INTEGER(4)

## Result Value

On successful completion, this function returns 0. Otherwise, this function returns the following error.

**EINVAL**

The argument **thread** is invalid.

## **f\_pthread\_cleanup\_pop(exec)**

### Purpose

This subroutine should be paired with **f\_pthread\_cleanup\_push** in using the cleanup stack for thread safety. If the supplied argument **exec** contains a non-zero value, the last pushed cleanup function will be popped from the cleanup stack and executed, with the argument **arg** (from the last **f\_pthread\_cleanup\_push**) passed to the cleanup function.

If **exec** contains a zero value, the last pushed cleanup function will be popped from the cleanup stack, but will not be executed.

### Class

Subroutine

### Argument Type and Attributes

**exec** INTEGER(4), INTENT(IN)

### Result Type and Attributes

None.

### Result Value

None.

## **f\_pthread\_cleanup\_push(cleanup, flag, arg)**

### Purpose

This function can be used to register a cleanup subroutine for the calling thread. In case of an unexpected termination of the calling thread, the system will automatically execute the cleanup subroutine in order for the calling thread to terminate safely. The argument **cleanup** must be a subroutine expecting exactly one argument. If it is executed, the argument **arg** will be passed to it as the actual argument.

The argument **arg** is a generic argument that can be of any type and any rank. The actual argument **arg** must be a variable, and consequently eligible as a left-value in an assignment statement. If you pass an array section with vector subscripts to the argument **arg**, the result is unpredictable.

If the actual argument **arg** is an array section, the corresponding dummy argument in subroutine **cleanup** must be an assumed-shape array. Otherwise, the result is unpredictable.

If the actual argument **arg** has the pointer attribute that points to an array or array section, the corresponding dummy argument in subroutine **cleanup** must have a pointer attribute or be an assumed-shape array. Otherwise, the result is unpredictable.

For a normal execution path, this function must be paired with a call to **f\_pthread\_cleanup\_pop**.

The argument **flag** must be used to convey the property of argument **arg** exactly to the system.

## Class

Function

## Argument Type and Attributes

### **cleanup**

A subroutine that has one dummy argument.

**flag** Flag is an INTEGER(4), INTENT(IN) argument that can contain one of, or a combination of, the following constants:

#### **FLAG\_CHARACTER:**

if the entry subroutine **cleanup** expects an argument of type **CHARACTER** in any way or any form, this flag value must be included to indicate this fact. However, if the subroutine expects a Fortran 90 pointer pointing to an argument of type **CHARACTER**, the **FLAG\_DEFAULT** value should be included instead.

#### **FLAG\_ASSUMED\_SHAPE:**

if the entry subroutine **cleanup** has a dummy argument that is an assumed-shape array of any rank, this flag value must be included to indicate this fact.

#### **FLAG\_DEFAULT:**

otherwise, this flag value is needed.

**arg** A generic argument that can be of any type, kind, and rank.

## Result Type and Attributes

INTEGER(4)

## Result Value

On successful completion, this function returns 0. Otherwise, this function returns one of the following errors.

### **ENOMEM**

The system cannot allocate memory to push this routine.

### **EAGAIN**

The system cannot allocate resources to push this routine.

### **EINVAL**

The argument **flag** is invalid.



## **f\_pthread\_cond\_broadcast(cond)**

### **Purpose**

This function will unblock all threads waiting on the condition variable **cond**. If there is no thread waiting on this condition variable, the function will still succeed, but the next caller to **f\_pthread\_cond\_wait** will be blocked, and will wait on the condition variable **cond**.

### **Class**

Function

### **Argument Type and Attributes**

**cond** TYPE(f\_pthread\_cond\_t), INTENT(INOUT)

### **Result Type and Attributes**

INTEGER(4)

### **Result Value**

On successful completion, this function returns 0. Otherwise, this function returns following error.

**EINVAL**

The argument **cond** is invalid.

## **f\_pthread\_cond\_destroy(cond)**

### **Purpose**

This function can be used to destroy those condition variables that are no longer required. The target condition variable is identified by the argument **cond**. System resources allocated during initialization will be recollected by the system. For further details about thread synchronization and condition variable usage, refer to the AIX Operating System information.

### **Class**

Function

### **Argument Type and Attributes**

**cond** TYPE(f\_pthread\_cond\_t), INTENT(INOUT)

### **Result Type and Attributes**

INTEGER(4)

### **Result Value**

On successful completion, this function returns 0. Otherwise, this function returns one of the following errors.

**EBUSY**

The condition variable **cond** is being used by another thread.

EINVAL

The argument **cond** is invalid.

## **f\_thread\_cond\_init(cond, cattr)**

### **Purpose**

This function can be used to dynamically initialize a condition variable **cond**. Its attributes will be set according to the attribute object **cattr**, if it is provided; otherwise, its attributes will be set to the system default. After the condition variable is initialized successfully, it can be used to synchronize threads. For further details about thread synchronization and condition variable usage, refer to the AIX Operating System information.

Another method of initializing a condition variable is to initialize it statically using the Fortran constant **PTHREAD\_COND\_INITIALIZER**.

### **Class**

Function

### **Argument Type and Attributes**

**cond** TYPE(f\_thread\_cond\_t), INTENT(INOUT)

**cattr** TYPE(f\_thread\_condattr\_t), INTENT(IN), OPTIONAL

### **Result Type and Attributes**

INTEGER(4)

### **Result Value**

On successful completion, this function returns 0. Otherwise, this function returns one of the following errors.

**EBUSY**

The condition variable is already in use. It is initialized and not destroyed.

**EINVAL**

The argument **cond** or **cattr** is invalid.

## **f\_thread\_cond\_signal(cond)**

### **Purpose**

This function will unblock at least one thread waiting on the condition variable **cond**. If there is no thread waiting on this condition variable, the function will still succeed, but the next caller to **f\_thread\_cond\_wait** will be blocked, and will wait on the condition variable **cond**. For further details about thread synchronization and condition variable usage, refer to the AIX Operating System information.

### **Class**

Function

### **Argument Type and Attributes**

**cond** TYPE(f\_thread\_cond\_t), INTENT(INOUT)

## Result Type and Attributes

INTEGER(4)

### Result Value

On successful completion, this function returns 0. Otherwise, this function returns the following error.

EINVAL

The argument **cond** is invalid.

## f\_pthread\_cond\_t

### Purpose

A derived data type whose components are all private. Any object of this type should be manipulated through the appropriate interfaces provided in this module. In addition, objects of this type can be initialized at compile time using the Fortran constant `PTHREAD_COND_INITIALIZER`.

This data type corresponds to the POSIX `pthread_cond_t`, which is the type of condition variable object.

### Class

Data Type.

## f\_pthread\_cond\_timedwait(cond, mutex, timeout)

### Purpose

This function can be used to wait for a certain condition to occur. The argument **mutex** must be locked before calling this function. The mutex is unlocked atomically and the calling thread waits for the condition to occur. The argument **timeout** specifies a deadline before which the condition must occur. If the deadline is reached before the condition occurs, the function will return an error code. This function provides a cancellation point in that the calling thread can be canceled if it is in the enabled state.

The argument **timeout** will specify an absolute date of the form: Oct. 31 10:00:53, 1998. For related information, see `f_maketime` and `f_timespec`. For a description of the absolute date, refer to the AIX Operating System information.

### Class

Function

### Argument Type and Attributes

**cond** TYPE(f\_pthread\_cond\_t), INTENT(INOUT)

**mutex** TYPE(f\_pthread\_mutex\_t), INTENT(INOUT)

**timeout**  
TYPE(f\_timespec), INTENT(IN)

## Result Type and Attributes

INTEGER(4)

## Result Value

On successful completion, this function returns 0. Otherwise this function returns one of the following errors:

**EINVAL**

The argument **cond**, **mutex**, or **timeout** is invalid.

**EDEADLK**

The argument **mutex** is not locked by the calling thread.

**ETIMEDOUT**

The waiting deadline was reached before the condition occurred.

## **f\_pthread\_cond\_wait(cond, mutex)**

### Purpose

This function can be used to wait for a certain condition to occur. The argument **mutex** must be locked before calling this function. The mutex is unlocked atomically, and the calling thread waits for the condition to occur. If the condition does not occur, the function will wait until the calling thread is terminated in another way. This function provides a cancelation point in that the calling thread can be canceled if it is in the enabled state.

### Class

Function

### Argument Type and Attributes

**cond** TYPE(f\_pthread\_cond\_t), INTENT(INOUT)

**mutex** TYPE(f\_pthread\_mutex\_t), INTENT(INOUT)

## Result Type and Attributes

INTEGER(4)

## Result Value

When this function executes successfully, the **mutex** is locked again before the function returns. Otherwise, this function returns one of the following errors.

**EINVAL**

The argument **cond** or **mutex** is invalid.

**EDEADLK**

The **mutex** is not locked by the calling thread.

## **f\_pthread\_condattr\_destroy(cattr)**

### Purpose

This function can be called to destroy the condition variable attribute objects that are no longer required. The target object is identified by the argument **cattr**. The

system resources allocated when it is initialized will be recollected.

## Class

Function

## Argument Type and Attributes

**cattr** TYPE(f\_thread\_condattr\_t), INTENT(INOUT)

## Result Type and Attributes

INTEGER(4)

## Result Value

On successful completion, this function returns 0. Otherwise, this function returns the following error.

**EINVAL**

The argument **cattr** is invalid.

## **f\_thread\_condattr\_getpshared(cattr, pshared)**

### Purpose

This function can be used to query the process-shared attribute of the condition variable attributes object identified by the argument **cattr**. The current setting of this attribute will be returned in the argument **pshared**.

## Class

Function

## Argument Type and Attributes

**cattr** TYPE(f\_thread\_condattr\_t), INTENT(IN)

**pshared**

INTEGER(4), INTENT(OUT)

On successful completion, **pshared** contains one of the following values:

### **PTHREAD\_PROCESS\_SHARED**

The condition variable can be used by any thread that has access to the memory where it is allocated, even if these threads belong to different processes.

### **PTHREAD\_PROCESS\_PRIVATE**

The condition variable shall only be used by threads within the same process as the thread that created it.

## Result Type and Attributes

INTEGER(4)

## Result Value

On successful completion, this function returns 0. Otherwise, this function returns the following error.

EINVAL

The argument `cattr` is invalid.

## **f\_thread\_condattr\_init(cattr)**

### **Purpose**

Use this function to initialize a condition variable attributes object `cattr` with the default value for all of the attributes defined by the implementation. Attempting to initialize an already initialized condition variable attributes object results in undefined behavior. After a condition variable attributes object has been used to initialize one or more condition variables, any function affecting the attributes object (including destruction) does not affect any previously initialized condition variables.

### **Class**

Function

### **Argument Type and Attributes**

`cattr` TYPE(`f_thread_condattr_t`), INTENT(OUT)

### **Result Type and Attributes**

INTEGER(4)

### **Result Value**

On successful completion, this function returns 0. Otherwise, this function returns the following error.

ENOMEM

There is insufficient memory to initialize the condition variable attributes object.

## **f\_thread\_condattr\_setshared(cattr, pshared)**

### **Purpose**

This function is used to set the process-shared attribute of the condition variable attributes object identified by the argument `cattr`. Its process-shared attribute will be set according to the argument `pshared`.

### **Class**

Function

### **Argument Type and Attributes**

`cattr` TYPE(`f_thread_condattr_t`), INTENT(INOUT)

`pshared`

is an INTEGER(4), INTENT(IN) argument that must contain one of the following values:

**PTHREAD\_PROCESS\_SHARED**

Specifies that the condition variable can be used by any thread that

has access to the memory where it is allocated, even if these threads belong to different processes.

#### **PTHREAD\_PROCESS\_PRIVATE**

Specifies that the condition variable shall only be used by threads within the same process as the thread that created it. This is the default setting of the attribute.

### **Result Type and Attributes**

INTEGER(4)

### **Result Value**

On successful completion, this function returns 0. Otherwise, this function returns the following error.

**EINVAL**

The value specified by the argument **cattr** or **pshared** is invalid.

## **f\_pthread\_condattr\_t**

### **Purpose**

A derived data type whose components are all private. Any object of this type should be manipulated only through the appropriate interfaces provided in this module.

This data type corresponds to the POSIX **pthread\_condattr\_t**, which is the type of condition variable attribute object.

### **Class**

Data Type

## **f\_pthread\_create(thread, attr, flag, ent, arg)**

### **Purpose**

This function is used to create a new thread in the current process. The newly created thread will assume the attributes defined in the thread attribute object **attr**, if it is provided. Otherwise, the new thread will have system default attributes. The new thread will begin execution at the subroutine **ent**, which is required to have one dummy argument. The system will pass the argument **arg** to the thread entry subroutine **ent** as its actual argument. The argument **flag** is used to inform the system of the property of the argument **arg**. When the execution returns from the entry subroutine **ent**, the new thread will terminate automatically.

If subroutine **ent** was declared such that an explicit interface would be required if it was called directly, then an explicit interface is also required when it is passed as an argument to this function.

The argument **arg** is a generic argument that can be of any type and any rank. The actual argument **arg** must be a variable, and consequently eligible as a left- value in an assignment statement. If you pass an array section with vector subscripts to the argument **arg**, the result is unpredictable.

If the actual argument **arg** is an array section, the corresponding dummy argument in subroutine **ent** must be an assumed-shape array. Otherwise, the result is unpredictable.

If the actual argument **arg** has the pointer attribute that points to an array or array section, the corresponding dummy argument in subroutine **ent** must have a pointer attribute or be an assumed-shape array. Otherwise, the result is unpredictable.

## Class

Function

### Argument Type and Attributes

**thread** TYPE(f\_thread\_t), INTENT(OUT)

On successful completion of the function, **f\_thread\_create** stores the ID of the created thread in the **thread**.

**attr** TYPE(f\_thread\_attr\_t), INTENT(IN)

**flag** INTEGER(4), INTENT(IN)

The argument **flag** must convey the property of the argument **arg** exactly to the system. The argument **flag** can be one of, or a combination of, the following constants:

#### FLAG\_CHARACTER:

if the entry subroutine **ent** expects an argument of type **CHARACTER** in any way or any form, this flag value must be included to indicate this fact. However, if the subroutine expects a Fortran 90 pointer pointing to an argument of type **CHARACTER**, the **FLAG\_DEFAULT** value should be included instead.

#### FLAG\_ASSUMED\_SHAPE:

if the entry subroutine **ent** has a dummy argument which is an assumed-shape array of any rank, this flag value must be included to indicate this fact.

#### FLAG\_DEFAULT:

otherwise, this flag value is needed.

**ent** A subroutine that has one dummy argument of any type, kind and rank.

**arg** A generic argument of any type, kind, and rank. It is passed to **ent** as the only actual argument.

### Result Type and Attributes

INTEGER(4)

### Result Value

On successful completion, this function returns 0. Otherwise, this function returns one of the following errors.

#### EAGAIN

The system does not have enough resources to create a new thread.

#### EINVAL

The argument **thread**, **attr**, or **flag** is invalid.



ENOMEM

The system does not have sufficient memory to create a new thread.

## **f\_thread\_detach(thread)**

### **Purpose**

This function is used to indicate to the pthreads library implementation that storage for the thread whose thread ID is specified by the argument `thread` can be claimed when this thread terminates. If the thread has not yet terminated, `f_thread_detach` shall not cause it to terminate. Multiple `f_thread_detach` calls on the same target thread cause an error.

### **Class**

Function

### **Argument Type and Attributes**

`thread` TYPE(`f_thread_t`), INTENT(IN)

### **Result Type and Attributes**

INTEGER(4)

### **Result Value**

On successful completion, this function returns 0. Otherwise, this function returns the following error.

EINVAL

The argument `thread` is invalid.

## **f\_thread\_equal(thread1, thread2)**

### **Purpose**

This function can be used to compare whether two thread ID's identify the same thread or not.

### **Class**

Function

### **Argument Type and Attributes**

`thread1`

TYPE(`f_thread_t`), INTENT(IN)

`thread2`

TYPE(`f_thread_t`), INTENT(IN)

### **Result Type and Attributes**

LOGICAL(4)

### **Result Value**

TRUE The two thread ID's identify the same thread.

FALSE

The two thread ID's do not identify the same thread.

## **f\_thread\_exit(ret)**

### **Purpose**

This subroutine can be called explicitly to terminate the calling thread before it returns from the entry subroutine. The actions taken depend on the state of the calling thread. If it is in non-detached state, the calling thread will wait to be joined. If the thread is in detached state, or when it is joined by another thread, the calling thread will terminate safely. First, the cleanup stack will be popped and executed, and then any thread-specific data will be destructed by the destructors. Finally, the thread resources are freed and the argument **ret** will be returned to the joining threads. The argument **ret** of this subroutine is optional. Currently, argument **ret** is limited to be an Integer pointer. If it is not an Integer pointer, the behavior is undefined. Calling **f\_thread\_exit** will not automatically free all of the memory allocated to a thread. To avoid memory leaks, finalization must be handled separately from **f\_thread\_exit**.

This subroutine never returns. If argument **ret** is not provided, NULL will be provided as this thread's exit status.

### **Class**

Subroutine

### **Argument Type and Attributes**

**ret** Integer pointer, OPTIONAL, INTENT(IN)

### **Result Type and Attributes**

None

### **Result Value**

None

## **f\_thread\_getconcurrency()**

### **Purpose**

This function returns the value of the concurrency level set by a previous call to the **f\_thread\_setconcurrency** function. If the **f\_thread\_setconcurrency** function was not previously called, this function returns zero to indicate that the system is maintaining the concurrency level.

For a description of the concurrency level, refer to the AIX Operating System information.

### **Class**

Function

## Argument Type and Attributes

None

## Result Type and Attributes

INTEGER(4)

## Result Value

This function returns the value of the concurrency level set by a previous call to the `f_pthread_setconcurrency` function. If the `f_pthread_setconcurrency` function was not previously called, this function returns 0.

## `f_pthread_getschedparam(thread, policy, param)`

### Purpose

This function can be used to query the current setting of the scheduling property of the target thread. The target thread is identified by argument `thread`. Its scheduling policy will be returned through argument `policy` and its scheduling property through argument `param`. The `sched_priority` field in `param` defines the scheduling priority. The priority field will assume a value in the range of 1-127, where 127 is the most favored scheduling priority while 1 is the least.

### Class

Function

### Argument Type and Attributes

`thread` TYPE(`f_pthread_t`), INTENT(IN)

`policy` INTEGER(4), INTENT(OUT)

`param` TYPE(`f_sched_param`), INTENT(OUT)

### Result Type and Attributes

INTEGER(4)

### Result Value

On successful completion, this function returns 0. Otherwise, this function returns one of the following errors.

#### ENOSYS

The POSIX priority scheduling option is not implemented on AIX.

#### ESRCH

The target thread does not exist.

## `f_pthread_getspecific(key, arg)`

### Purpose

This function can be used to retrieve the thread-specific data associated with `key`. Note that the argument `arg` is not optional in this function as it will return the thread-specific data. After execution of the procedure, the argument `arg` holds a

pointer to the data, or NULL if there is no data to retrieve. The argument **arg** must be an Integer pointer, or the result is undefined.

The actual argument **arg** must be a variable, and consequently eligible as a left-value in an assignment statement. If you pass an array section with vector subscripts to the argument **arg**, the result is unpredictable.

## Class

Function

## Argument Type and Attributes

**key** TYPE(f\_thread\_key\_t), INTENT(IN)

**arg** Integer pointer, INTENT(OUT)

## Result Type and Attributes

INTEGER(4)

## Result Value

On successful completion, this function returns 0. Otherwise, this function returns the following error.

**EINVAL**

The argument **key** is invalid.

## **f\_thread\_join(thread, ret)**

### Purpose

This function can be called to join a particular thread designated by the argument **thread**. If the target thread is in non-detached state and is already terminated, this call will return immediately with the target thread's status returned in argument **ret** if it is provided. The argument **ret** is optional. Currently, **ret** must be an Integer pointer if it is provided.

If the target thread is in detached state, it is an error to join it.

## Class

Function

## Argument Type and Attributes

**thread** TYPE(f\_thread\_t), INTENT(IN)

**ret** Integer pointer, INTENT(OUT), OPTIONAL

## Result Type and Attributes

INTEGER(4)

## Result Value

On successful completion, this function returns 0. Otherwise, this function returns one of the following errors.

**EDEADLK**

This call will cause a deadlock, or the calling thread is trying to join itself.

**EINVAL**

The argument **thread** is invalid.

**ESRCH**

The argument **thread** designates a thread which does not exist or is in detached state.

**f\_pthread\_key\_create(key, dtr)****Purpose**

This function can be used to acquire a thread-specific data key. The key will be returned in the argument **key**. The argument **dtr** is a subroutine that will be used to destruct the thread-specific data associated with this key when any thread terminates after this calling point. The destructor will receive the thread-specific data as its argument. The destructor itself is optional. If it is not provided, the system will not invoke any destructor on the thread-specific data associated with this key. Note that the number of thread-specific data keys is limited in each process. It is the user's responsibility to manage the usage of the keys. The per-process limit can be checked by the Fortran constant **PTHREAD\_DATAKEYS\_MAX**.

**Class**

Function

**Argument Type and Attributes**

**key** TYPE(f\_pthread\_key\_t), INTENT(OUT)

**dtr** External, optional subroutine

**Result Type and Attributes**

INTEGER(4)

**Result Value**

On successful completion, this function returns 0. Otherwise, this function returns one of the following errors.

**EAGAIN**

The maximum number of keys has been exceeded.

**EINVAL**

The argument **key** is invalid.

**ENOMEM**

There is insufficient memory to create this key.

**f\_pthread\_key\_delete(key)****Purpose**

This function will destroy the thread-specific data key identified by the argument **key**. It is the user's responsibility to ensure that there is no thread-specific data associated with this key. This function does not call any destructor on the thread's

behalf. After the key is destroyed, it can be reused by the system for `f_pthread_key_create` requests.

## Class

Function

## Argument Type and Attributes

`key` TYPE(`f_pthread_key_t`), INTENT(INOUT)

## Result Type and Attributes

INTEGER(4)

## Result Value

On successful completion, this function returns 0. Otherwise, this function returns one of the following errors.

### EINVAL

The argument `key` is invalid.

### EBUSY

There is still data associated with this key.

## `f_pthread_key_t`

### Purpose

A derived data type whose components are all private. Any object of this type should be manipulated only through the appropriate interfaces provided in this module.

This data type corresponds to the POSIX `pthread_key_t`, which is the type of key object for accessing thread-specific data.

## Class

Data Type

## `f_pthread_kill(thread, sig)`

### Purpose

This function can be used to send a signal to a target thread. The target thread is identified by argument `thread`. The signal which will be sent to the target thread is identified in argument `sig`. If `sig` contains value zero, error checking will be done by the system but no signal will be sent. For further details about signal management in multithreaded systems, refer to the AIX Operating System information.

## Class

Function

## Argument Type and Attributes

`thread` TYPE(`f_pthread_t`), INTENT(INOUT)

**sig** INTEGER(4), INTENT(IN)

### **Result Type and Attributes**

INTEGER(4)

### **Result Value**

On successful completion, this function returns 0. Otherwise, this function returns one of the following errors.

**EINVAL**

The argument **thread** or **sig** is invalid.

**ESRCH**

The target thread does not exist.

## **f\_pthread\_mutex\_destroy(mutex)**

### **Purpose**

This function should be called to destroy those mutex objects that are no longer required. In this way, the system can recollect the memory resources. The target mutex object is identified by the argument **mutex**.

### **Class**

Function

### **Argument Type and Attributes**

**mutex** TYPE(f\_pthread\_mutex\_t), INTENT(INOUT)

### **Result Type and Attributes**

INTEGER(4)

### **Result Value**

On successful completion, this function returns 0. Otherwise, this function returns one of the following errors.

**EBUSY**

The target mutex is locked or referenced by another thread.

**EINVAL**

The argument **mutex** is invalid.

## **f\_pthread\_mutex\_getprioceiling(mutex, old)**

### **Purpose**

This function can be used to dynamically query the priority ceiling attribute of the mutex object identified by the argument **mutex**. The current ceiling value will be returned through the argument **old**.

### **Class**

Function

## Argument Type and Attributes

**mutex** TYPE(f\_thread\_mutex\_t), INTENT(IN)

**old** INTEGER(4), INTENT(OUT)

## Result Type and Attributes

INTEGER(4)

## Result Value

On successful completion, this function returns 0. Otherwise, this function returns one of the following errors.

**ENOSYS**

This function is not implemented on AIX.

## f\_thread\_mutex\_init(mutex, mattr)

### Purpose

This function can be used to initialize the mutex object identified by argument **mutex**. The initialized mutex will assume attributes set in the mutex attribute object **mattr**, if it is provided. If **mattr** is not provided, the system will initialize the mutex to have default attributes. After it is initialized, the mutex object can be used to synchronize accesses to critical data or code. It can also be used to build more complicated thread synchronization objects.

Another method to initialize mutex objects is to statically initialize them through the Fortran constant **PTHREAD\_MUTEX\_INITIALIZER**. If this method of initialization is used it is not necessary to call the function before using the mutex objects.

### Class

Function

## Argument Type and Attributes

**mutex** TYPE(f\_thread\_mutex\_t), INTENT(OUT)

**mattr** TYPE(f\_thread\_mutexattr\_t), INTENT(IN), OPTIONAL

## Result Type and Attributes

INTEGER(4)

## Result Value

On successful completion, this function returns 0. Otherwise, this function returns one of the following errors.

**EAGAIN**

The system did not have enough resources to initialize this mutex.

**EBUSY**

This mutex is already in use. It was initialized and not destroyed.



EINVAL

The argument **mutex** or **matr** is invalid.

ENOMEM

There is insufficient memory to initialize this mutex.

## **f\_thread\_mutex\_lock(mutex)**

### **Purpose**

This function can be used to acquire ownership of the mutex object. (In other words, the function will lock the mutex.) If the mutex has already been locked by another thread, the caller will wait until the mutex is unlocked. If the mutex is already locked by the caller itself, an error will be returned to prevent recursive locking.

### **Class**

Function

### **Argument Type and Attributes**

**mutex** TYPE(f\_thread\_mutex\_t), INTENT(INOUT)

### **Result Type and Attributes**

INTEGER(4)

### **Result Value**

On successful completion, this function returns 0. Otherwise, this function returns one of the following errors.

EDEADLK

The mutex is locked by the calling thread already.

EINVAL

The argument **mutex** is invalid.

## **f\_thread\_mutex\_setprioceiling(mutex, new, old)**

### **Purpose**

This function can be used to dynamically set the priority ceiling attribute of the mutex object identified by the argument **mutex**. The new ceiling will be set to the value contained in the argument **new**. The previous ceiling will be returned through the argument **old**. The argument **new** should assume an integer value with a range from 1 to 127.

### **Class**

Function

### **Argument Type and Attributes**

**mutex** TYPE(f\_thread\_mutex\_t), INTENT(INOUT)

**new** INTEGER(4), INTENT(IN)

**old** INTEGER(4), INTENT(OUT)

## Result Type and Attributes

INTEGER(4)

## Result Value

On successful completion, this function returns 0. Otherwise, this function returns the following error.

**ENOSYS**

This function is not implemented on AIX.

## **f\_thread\_mutex\_t**

### Purpose

A derived data type whose components are all private. Any object of this type should be manipulated through the appropriate interfaces provided in this module. In addition, objects of this type can be initialized statically through the Fortran constant **PTHREAD\_MUTEX\_INITIALIZER**.

This data type corresponds to the POSIX **pthread\_mutex\_t**, which is the type of mutex object.

### Class

Data Type

## **f\_thread\_mutex\_trylock(mutex)**

### Purpose

This function can be used to acquire ownership of the mutex object. (In other words, the function will lock the mutex.) If the mutex has already been locked by another thread, the function returns the error code **EBUSY**. The calling thread can check the return code to take further actions. If the mutex is already locked by the caller itself, an error will be returned to prevent recursive locking.

### Class

Function

### Argument Type and Attributes

**mutex** TYPE(f\_thread\_mutex\_t), INTENT(INOUT)

### Result Type and Attributes

INTEGER(4)

### Result Value

On successful completion, this function returns 0. Otherwise, this function returns one of the following errors.

**EBUSY**

The target mutex is locked or referenced by another thread.

**EDEADLK**

The mutex is locked by the calling thread already.

**EINVAL**

The argument **mutex** is invalid.

## **f\_thread\_mutex\_unlock(mutex)**

### **Purpose**

This function releases the mutex object's ownership in order to allow other threads to lock the mutex.

### **Class**

Function

### **Argument Type and Attributes**

**mutex** TYPE(f\_thread\_mutex\_t), INTENT(INOUT)

### **Result Type and Attributes**

INTEGER(4)

### **Result Value**

On successful completion, this function returns 0. Otherwise, this function returns one of the following errors.

**EINVAL**

The argument **mutex** is invalid.

**EPERM**

The mutex is not locked by the calling thread.

## **f\_thread\_mutexattr\_destroy(mattr)**

### **Purpose**

This function can be used to destroy a mutex attribute object that has been initialized previously. Allocated memory will then be recollected. A mutex created with this attribute will not be affected by this action.

### **Class**

Function

### **Argument Type and Attributes**

**mattr** TYPE(f\_thread\_mutexattr\_t), INTENT(INOUT)

### **Result Type and Attributes**

INTEGER(4)

## Result Value

On successful completion, this function returns 0. Otherwise, this function returns the following error.

**EINVAL**

The argument **mattr** is invalid.

## **f\_thread\_mutexattr\_getprioceiling(mattr, ceiling)**

### Purpose

This function can be used to query the mutex priority ceiling attribute in the mutex attribute object identified by argument **mattr**. The ceiling attribute will be returned through argument **ceiling**.

### Class

Function

### Argument Type and Attributes

**mattr** TYPE(f\_thread\_mutexattr\_t), INTENT(IN)

**ceiling**  
INTEGER(4), INTENT(OUT)

### Result Type and Attributes

INTEGER(4)

### Result Value

On successful completion, this function returns 0. Otherwise, this function returns the following error.

**ENOSYS**

This function is not implemented on AIX.

## **f\_thread\_mutexattr\_getprotocol(mattr, proto)**

### Purpose

This function can be used to query the current setting of mutex protocol attribute in the mutex attribute object identified by argument **mattr**. The protocol attribute will be returned through argument **proto**.

### Class

Function

### Argument Type and Attributes

**mattr** TYPE(f\_thread\_mutexattr\_t), INTENT(IN)

**proto** INTEGER(4), INTENT(OUT)

### Result Type and Attributes

INTEGER(4)

## Result Value

On successful completion, this function returns 0. Otherwise, this function returns the following error.

**ENOSYS**

This function is not implemented on AIX.

## **f\_thread\_mutexattr\_getpshared(mattr, pshared)**

### Purpose

This function is used to query the process-shared attribute in the mutex attributes object identified by the argument **mattr**. The current setting of the attribute will be returned through the argument **pshared**.

### Class

Function

### Argument Type and Attributes

**mattr** TYPE(f\_thread\_mutexattr\_t), INTENT(IN)

**pshared**

INTEGER(4), INTENT(IN)

On return from this function, **pshared** contains one of the following values:

#### **PTHREAD\_PROCESS\_SHARED**

The mutex can be operated upon by any thread that has access to the memory where the mutex is allocated, even if the mutex is allocated in memory that is shared by multiple processes.

#### **PTHREAD\_PROCESS\_PRIVATE**

The mutex will only be operated upon by threads created within the same process as the thread that initialized the mutex.

### Result Type and Attributes

INTEGER(4)

### Result Value

If this function completes successfully, value 0 is returned and the value of the process-shared attribute is returned through the argument **pshared**. Otherwise, the following error will be returned:

**EINVAL**

The argument **mattr** is invalid.

## **f\_thread\_mutexattr\_gettype(mattr, type)**

### Purpose

This function is used to query the mutex type attribute in the mutex attributes object identified by the argument **mattr**.

If this function completes successfully, value 0 is returned and the type attribute will be returned through the argument **type**.

## Class

Function

### Argument Type and Attributes

**matr** TYPE(f\_thread\_mutexattr\_t), INTENT(IN)

**type** INTEGER(4), INTENT(OUT)

On return from this function, **type** contains one of the following values:

#### **PTHREAD\_MUTEX\_NORMAL**

This type of mutex does not detect deadlock. A thread attempting to relock this mutex without first unlocking it will deadlock.

Attempting to unlock a mutex locked by a different thread results in undefined behavior.

#### **PTHREAD\_MUTEX\_ERRORCHECK**

This type of mutex provides error checking. A thread attempting to relock this mutex without first unlocking it will return with an error. A thread attempting to unlock a mutex which another thread has locked will return an error. A thread attempting to unlock an unlocked mutex will return with an error.

#### **PTHREAD\_MUTEX\_RECURSIVE**

A thread attempting to relock this mutex without first unlocking it will succeed in locking the mutex. The relocking deadlock that can occur with mutexes of type **PTHREAD\_MUTEX\_NORMAL** cannot occur with this type of mutex. Multiple locks of this mutex require the same number of unlocks to release the mutex before another thread can acquire the mutex.

### Result Type and Attributes

INTEGER(4)

### Result Value

On successful completion, this function returns 0. Otherwise, this function returns the following error.

**EINVAL**

The argument is invalid.

## **f\_thread\_mutexattr\_init(matr)**

### **Purpose**

This function can be used to initialize a mutex attribute object before it can be used in any other way. The mutex attribute object will be returned through argument **matr**.

## Class

Function

### Argument Type and Attributes

**matr** TYPE(f\_thread\_mutexattr\_t), INTENT(OUT)

## Result Type and Attributes

INTEGER(4)

## Result Value

On successful completion, this function returns 0. Otherwise, this function returns the following error.

EINVAL

The argument **mattr** is invalid.

ENOMEM

There is insufficient memory to create the object.

## **f\_pthread\_mutexattr\_setprioceiling(mattr, ceiling)**

### Purpose

This function can be used to set the mutex priority ceiling attribute in the mutex attribute object identified by the argument **mattr**. Argument **ceiling** is an integer with a range from 1 to 127. This attribute has an effect only if the mutex priority protection protocol is used.

### Class

Function

### Argument Type and Attributes

**mattr** TYPE(f\_pthread\_mutexattr\_t), INTENT(INOUT)

**ceiling**

INTEGER(4), INTENT(IN)

### Result Type and Attributes

INTEGER(4)

### Result Value

On successful completion, this function returns 0. Otherwise, this function returns the following error.

ENOSYS

This function is not implemented on AIX.

## **f\_pthread\_mutexattr\_setprotocol(mattr, proto)**

### Purpose

This function can be used to set the mutex protocol attribute in the mutex attribute object identified by argument **mattr**. Argument **proto** identifies the mutex protocol to be set. For descriptions of the set of valid values for **proto**, refer to the AIX Operating System information.

### Class

Function

## Argument Type and Attributes

**mattr** TYPE(f\_thread\_mutexattr\_t), INTENT(INOUT)

**proto** INTEGER(4), INTENT(IN)

## Result Type and Attributes

INTEGER(4)

## Result Value

On successful completion, this function returns 0. Otherwise, this function returns the following error.

**ENOSYS**

This function is not implemented on AIX.

## f\_thread\_mutexattr\_setpshared(mattr, pshared)

### Purpose

This function is used to set the process-shared attribute of the mutex attributes object identified by the argument **mattr**.

### Class

Function

## Argument Type and Attributes

**mattr** TYPE(f\_thread\_mutexattr\_t), INTENT(INOUT)

**pshared**

INTEGER(4), INTENT(IN)

Must contain one of the following values:

### **PTHREAD\_PROCESS\_SHARED**

Specifies the mutex can be operated upon by any thread that has access to the memory where the mutex is allocated, even if the mutex is allocated in memory that is shared by multiple processes.

### **PTHREAD\_PROCESS\_PRIVATE**

Specifies the mutex will only be operated upon by threads created within the same process as the thread that initialized the mutex. This is the default setting of the attribute.

## Result Type and Attributes

INTEGER(4)

## Result Value

On successful completion, this function returns 0. Otherwise, this function returns the following error.

**EINVAL**

The argument is invalid.



## **f\_thread\_mutexattr\_settype(mattr, type)**

### **Purpose**

This function is used to set the mutex type attribute in the mutex attributes object identified by the argument **mattr**. The argument **type** identifies the mutex type attribute to be set.

For further details about the type of a mutex, refer to the AIX Operating System information.

### **Class**

Function

### **Argument Type and Attributes**

**mattr** TYPE(f\_thread\_mutexattr\_t), INTENT(INOUT)

**type** INTEGER(4), INTENT(IN)

Must contain one of the following values:

#### **PTHREAD\_MUTEX\_NORMAL**

This type of mutex does not detect deadlock. A thread attempting to relock this mutex without first unlocking it will deadlock. Attempting to unlock a mutex locked by a different thread results in undefined behavior.

#### **PTHREAD\_MUTEX\_ERRORCHECK**

This type of mutex provides error checking. A thread attempting to relock this mutex without first unlocking it will return with an error. A thread attempting to unlock a mutex which another thread has locked will return an error. A thread attempting to unlock an unlocked mutex will return with an error.

#### **PTHREAD\_MUTEX\_RECURSIVE**

A thread attempting to relock this mutex without first unlocking it will succeed in locking the mutex. The relocking deadlock that can occur with mutexes of type **PTHREAD\_MUTEX\_NORMAL** cannot occur with this type of mutex. Multiple locks of this mutex require the same number of unlocks to release the mutex before another thread can acquire the mutex.

#### **PTHREAD\_MUTEX\_DEFAULT**

The same as **PTHREAD\_MUTEX\_NORMAL**.

### **Result Type and Attributes**

INTEGER(4)

### **Result Value**

On successful completion, this function returns 0. Otherwise, this function returns the following error.

#### **EINVAL**

One of the arguments is invalid.

## **f\_thread\_mutexattr\_t**

### **Purpose**

A derived data type whose components are all private. Any object of this type should be manipulated only through the appropriate interfaces provided in this module.

This data type corresponds to the POSIX `pthread_mutexattr_t`, which is the type of mutex attribute object.

### **Class**

Data Type

## **f\_thread\_once(once, initr)**

### **Purpose**

This function can be used to initialize those data required to be initialized only once. The first thread calling this function will call `initr` to do the initialization. Other threads calling this function afterwards will have no effect. Argument `initr` must be a subroutine without dummy arguments.

### **Class**

Function

### **Argument Type and Attributes**

`once` TYPE(`f_thread_once_t`), INTENT(INOUT)

`initr` A subroutine that has no dummy arguments.

### **Result Type and Attributes**

INTEGER(4)

### **Result Value**

On successful completion, this function returns 0. Otherwise, this function returns the following error.

EINVAL

The argument `once` or `initr` is invalid.

## **f\_thread\_once\_t**

### **Purpose**

A derived data type whose components are all private. Any object of this type should be manipulated through the appropriate interfaces provided in this module. However, objects of this type can *only* be initialized through the Fortran constant `PTHREAD_ONCE_INIT`.

### **Class**

Data Type

## **f\_thread\_rwlock\_destroy(rwlock)**

### **Purpose**

This function destroys the read-write lock object specified by the argument **rwlock** and releases any resources used by the lock.

### **Class**

Function

### **Argument Type and Attributes**

**rwlock**

TYPE(f\_thread\_rwlock\_t), INTENT(INOUT)

### **Result Type and Attributes**

INTEGER(4)

### **Result Value**

On successful completion, this function returns 0. Otherwise, this function returns one of the following errors.

**EBUSY**

The target read-write object is locked.

**EINVAL**

The argument **rwlock** is invalid.

## **f\_thread\_rwlock\_init(rwlock, rwattr)**

### **Purpose**

This function initializes the read-write lock object specified by **rwlock** with the attribute specified by the argument **rwattr**. If the optional argument **rwattr** is not provided, the system will initialize the read-write lock object with the default attributes. After it is initialized, the lock can be used to synchronize access to critical data. With a read-write lock, many threads can have simultaneous read-only access to data, while only one thread can have write access at any given time and no other readers or writers are allowed. For further details of the thread synchronization and read-write lock usage, refer to the AIX Operating System information.

Another method to initialize read-write lock objects is to statically initialize them through the Fortran constant **PTHREAD\_RWLOCK\_INITIALIZER**. If this method of initialization is used, it is not necessary to call this function before using the read-write lock objects.

### **Class**

Function

### **Argument Type and Attributes**

**rwlock**

TYPE(f\_thread\_rwlock\_t), INTENT(OUT)

**rwattr** TYPE(f\_thread\_rwlockattr\_t), INTENT(IN), OPTIONAL

## Result Type and Attributes

INTEGER(4)

## Result Value

On successful completion, this function returns 0. Otherwise, this function returns one of the following errors.

### EAGAIN

The system did not have enough resources to initialize this read-write lock

### ENOMEM

There is insufficient memory to initialize this read-write lock.

### EBUSY

This read-write lock is already in use. It was initialized and not yet destroyed

### EINVAL

The argument **rwlock** or **rwattr** is invalid.

### EPERM

The caller does not have privilege to perform the operation.

## **f\_thread\_rwlock\_rdlock(rwlock)**

### Purpose

This function applies a read lock to the read-write lock specified by the argument **rwlock**. The calling thread acquires the read lock if a writer does not hold the lock and there are no writes blocked on the lock. Otherwise, the calling thread will not acquire the read lock. If the read lock is not acquired, the calling thread blocks (that is, it does not return from the **f\_thread\_rwlock\_rdlock** call) until it can acquire the lock. Results are undefined if the calling thread holds a write lock on **rwlock** at the time the call is made. A thread may hold multiple concurrent read locks on **rwlock** (that is, successfully call the **f\_thread\_rwlock\_rdlock** function *n* times). If so, the thread must perform matching unlocks (that is, it must call the **f\_thread\_rwlock\_unlock** function *n* times).

### Class

Function

## Argument Type and Attributes

**rwlock**

TYPE(f\_thread\_rwlock\_t), INTENT(INOUT)

## Result Type and Attributes

INTEGER(4)

## Result Value

On successful completion, this function returns 0. Otherwise, this function returns one of the following errors.

**EAGAIN**

The read-write lock could not be acquired because the maximum number of read locks for `rwlock` has been exceeded.

**EINVAL**

The argument `rwlock` does not refer to an initialized read-write lock object.

**f\_thread\_rwlock\_t****Purpose**

A derived data type whose components are all private. Any object of this type should be manipulated only through the appropriate interfaces provided in this module. In addition, objects of this type can be initialized statically through the Fortran constant `PTHREAD_RWLOCK_INITIALIZER`.

This data type corresponds to the AIX data type `pthread_rwlock_t`, which is the type of the read-write lock objects.

**Class**

Data Type

**f\_thread\_rwlock\_tryrdlock(rwlock)****Purpose**

This function applies a read lock like the `f_thread_rwlock_rdlock` function with the exception that the function fails if any thread holds a write lock on `rwlock` or there are writers blocked on `rwlock`. In that case, the function returns `EBUSY`. The calling thread can check the return code to take further actions.

**Class**

Function

**Argument Type and Attributes**

`rwlock`

TYPE(`f_thread_rwlock_t`), INTENT(INOUT)

**Result Type and Attributes**

INTEGER(4)

**Result Value**

This function returns zero if the lock for reading on the read-write lock object specified by `rwlock` is acquired. Otherwise, one of the following errors will be returned:

**EAGAIN**

The read-write lock could not be acquired because the maximum number of read locks for `rwlock` has been exceeded

**EBUSY**

The read-write lock could not be acquired for reading because a writer holds the lock or was blocked on it.

**EDEADLK**

The current thread already owns the read-write lock for writing.

**EINVAL**

The argument *rwlock* does not refer to an initialized read-write lock object.

## **f\_pthread\_rwlock\_trywrlock(*rwlock*)**

### **Purpose**

This function applies a write lock like the `f_pthread_rwlock_wrlock` function with the exception that the function fails if any thread currently holds *rwlock* (for reading or writing). In that case, the function returns **EBUSY**. The calling thread can check the return code to take further actions.

### **Class**

Function

### **Argument Type and Attributes**

*rwlock*

TYPE(*f\_pthread\_rwlock\_t*), INTENT(INOUT)

### **Result Type and Attributes**

INTEGER(4)

### **Result Value**

This function returns zero if the lock for writing on the read-write lock object specified by *rwlock* is acquired. Otherwise, one of the following errors will be returned:

**EBUSY**

The read-write lock could not be acquired for reading because a writer holds the lock or was blocked on it.

**EDEADLK**

The current thread already owns the read-write lock for writing.

**EINVAL**

The argument *rwlock* does not refer to an initialized read-write lock object.

## **f\_pthread\_rwlock\_unlock(*rwlock*)**

### **Purpose**

This function is used to release a lock held on the read-write lock object specified by the argument *rwlock*. If this function is called to release a read lock from the read-write lock object and there are other read locks currently held on this read-write lock object, the read-write lock object remains in the read locked state. If this function releases the calling thread's last read lock on this read-write lock object, then the calling thread is no longer one of the owners of the object. If this function releases the last read lock for this read-write lock object, the read-write lock object will be put in the unlocked state with no owners.

## Class

Function

## Argument Type and Attributes

**rwlock**

TYPE(f\_pthread\_rwlock\_t), INTENT(INOUT)

## Result Type and Attributes

INTEGER(4)

## Result Value

On successful completion, this function returns 0. Otherwise, this function returns one of the following errors.

**EINVAL**

The argument **rwlock** does not refer to an initialized read-write lock object.

**EPERM**

The current thread does not own the read-write lock.

## **f\_pthread\_rwlock\_wrlock(rwlock)**

### **Purpose**

This function applies a write lock to the read-write lock specified by the argument *rwlock*. The calling thread acquires the write lock if no other thread (reader or writer) holds the read-write lock *rwlock*. Otherwise, the thread blocks (that is, does not return from the **f\_pthread\_rwlock\_wrlock** call) until it acquires the lock. Results are undefined if the calling thread holds the read-write lock (whether a read or write lock) at the time the call is made.

## Class

Function

## Argument Type and Attributes

**rwlock**

TYPE(f\_pthread\_rwlock\_t), INTENT(INOUT)

## Result Type and Attributes

INTEGER(4)

## Result Value

On successful completion, this function returns 0. Otherwise, this function returns the following error.

**EINVAL**

The argument **rwlock** does not refer to an initialized read-write lock object.

## **f\_thread\_rwlockattr\_destroy(rwattr)**

### **Purpose**

This function destroys a read-write lock attributes object specified by the argument **rwattr** which has been initialized previously. A read-write lock created with this attribute will not be affected by the action.

### **Class**

Function

### **Argument Type and Attributes**

**rwattr** TYPE(f\_thread\_rwlockattr\_t), INTENT(INOUT)

### **Result Type and Attributes**

INTEGER(4)

### **Result Value**

On successful completion, this function returns 0. Otherwise, this function returns the following error.

**EINVAL**

The argument **rwattr** is invalid.

## **f\_thread\_rwlockattr\_getshared(rwattr, pshared)**

### **Purpose**

This function is used to obtain the value of the process-shared attribute from the initialized read-write lock attributes object specified by the argument **rwattr**. The current setting of this attribute will be returned in the argument **pshared**.

### **Class**

Function

### **Argument Type and Attributes**

**rwattr** TYPE(f\_thread\_rwlockattr\_t), INTENT(IN)

**pshared**

INTEGER(4), INTENT(OUT)

On return from this function, the value of **pshared** will be one of the following values:

#### **PTHREAD\_PROCESS\_SHARED**

The read-write lock can be operated upon by any thread that has access to the memory where it is allocated, even if these threads belong to different processes.

#### **PTHREAD\_PROCESS\_PRIVATE**

The read-write lock shall only be used by threads within the same process as the thread that created it.



## Result Type and Attributes

INTEGER(4)

## Result Value

If this function completes successfully, value 0 is returned and the value of the process-shared attribute of **rwattr** is stored into the object specified by the argument **pshared**. Otherwise, the following error will be returned:

EINVAL

The argument **rwattr** is invalid.

## **f\_thread\_rwlockattr\_init(rwattr)**

### Purpose

This function initializes a read-write lock attributes object specified by *rwattr* with the default value for all of the attributes.

### Class

Function

### Argument Type and Attributes

**rwattr** TYPE(f\_thread\_rwlockattr\_t), INTENT(OUT)

## Result Type and Attributes

INTEGER(4)

## Result Value

On successful completion, this function returns 0. Otherwise, this function returns the following error.

ENOMEM

There is insufficient memory to initialize the read-write lock attributes object.

## **f\_thread\_rwlockattr\_setpshared(rwattr, pshared)**

### Purpose

This function is used to set the process-shared attribute in an initialized read-write lock attributes object specified by the argument **rwattr**, based on the value provided by the argument **pshared**.

### Class

Function

### Argument Type and Attributes

**rwattr** TYPE(f\_thread\_rwlockattr\_t), INTENT(INOUT)

**pshared**

INTEGER(4), INTENT(IN)

Must be one of the following values:

**PTHREAD\_PROCESS\_SHARED**

Specifies the read-write lock can be operated upon by any thread that has access to the memory where it is allocated, even if these threads belong to different processes.

**PTHREAD\_PROCESS\_PRIVATE**

Specifies the read-write lock shall only be used by threads within the same process as the thread that created it. This is the default setting of the attribute.

**Result Type and Attributes**

INTEGER(4)

**Result Value**

On successful completion, this function returns 0. Otherwise, this function returns the following error:

**EINVAL**

The argument `rwattr` is invalid.

**f\_pthread\_rwlockattr\_t**

**Purpose**

This is a derived data type whose components are all private. Any object of this type should be manipulated only through the appropriate interfaces provided in this module.

This data type corresponds to the data type `pthread_rwlockattr_t`, which is the type of the read-write lock attributes objects.

**Class**

Data Type

**f\_pthread\_self()**

**Purpose**

This function can be used to return the thread ID of the calling thread.

**Class**

Function

**Argument Type and Attributes**

None

**Result Type and Attributes**

TYPE(f\_pthread\_t)

## Result Value

The calling thread's ID is returned.

## **f\_thread\_setcancelstate(state, oldstate)**

### Purpose

This function can be used to set the thread's cancelability state. The new state will be set according to the argument **state**. The old state will be returned in the argument **oldstate**.

### Class

Function

### Argument Type and Attributes

**state** INTEGER(4), INTENT(IN)

Must contain one of the following values:

**PTHREAD\_CANCEL\_DISABLE:**

The thread's cancelability is disabled.

**PTHREAD\_CANCEL\_ENABLE:**

The thread's cancelability is enabled.

**oldstate**

INTEGER(4), INTENT(OUT)

On return from this function, **oldstate** will contain one of the following values:

**PTHREAD\_CANCEL\_DISABLE:**

The thread's cancelability is disabled.

**PTHREAD\_CANCEL\_ENABLE:**

The thread's cancelability is enabled.

### Result Type and Attributes

INTEGER(4)

### Result Value

On successful completion, this function returns 0. Otherwise, this function returns the following error.

**EINVAL**

The argument **state** is invalid.

## **f\_thread\_setcanceltype(type, oldtype)**

### Purpose

This function can be used to set the thread's cancelability type. The new type will be set according to the argument **type**. The old type will be returned in argument **oldtype**.

## Class

Function

### Argument Type and Attributes

**type** INTEGER(4), INTENT(IN)

Must contain one of the following values:

**PTHREAD\_CANCEL\_DEFERRED:**

Cancelation request will be delayed until a cancelation point.

**PTHREAD\_CANCEL\_ASYNCHRONOUS:**

Cancelation request will be acted upon immediately. This may cause unexpected results.

**oldtype**

INTEGER(4), INTENT(OUT)

On return from this procedure, **oldtype** will contain one of the following values:

**PTHREAD\_CANCEL\_DEFERRED:**

Cancelation request will be delayed until a cancelation point.

**PTHREAD\_CANCEL\_ASYNCHRONOUS:**

Cancelation request will be acted upon immediately. This may cause unexpected results.

### Result Type and Attributes

INTEGER(4)

### Result Value

On successful completion, this function returns 0. Otherwise, this function returns the following error.

**EINVAL**

The argument **type** is invalid.

## **f\_pthread\_setconcurrency(new\_level)**

### Purpose

This function is used to inform the pthreads library implementation of the desired concurrency level as specified by the argument *new\_level*. The actual level of concurrency provided by the implementation as a result of this function call is unspecified. For further details about the concurrency level, refer to the AIX Operating System information.

## Class

Function

### Argument Type and Attributes

**new\_level**

INTEGER(4), INTENT(IN)

## Result Type and Attributes

INTEGER(4)

### Result Value

On successful completion, this function returns 0. Otherwise, this function returns one of the following errors.

#### EAGAIN

The value specified by `new_level` would cause system resource to be exceeded.

#### EINVAL

The value specified by `new_level` is negative.

## **f\_pthread\_setschedparam(thread, policy, param)**

### Purpose

This function can be used to dynamically set the scheduling policy and the scheduling property of a thread. The target thread is identified by argument **thread**. The new scheduling policy for the target thread is provided through argument **policy**. The valid scheduling policies on AIX can be found in the AIX Operating System information. The new scheduling property of the target thread will be set to the value provided by argument **param**. The `sched_priority` field in **param** defines the scheduling priority. Its range is 1-127.

The new policy cannot be set to first-in first-out or round-robin unless the caller has root authority. For more details about when the new scheduling property has effect on the target thread, refer to the AIX Operating System information.

### Class

Function

### Argument Type and Attributes

**thread** TYPE(f\_pthread\_t), INTENT(INOUT)

**policy** INTEGER(4), INTENT(IN)

**param** TYPE(f\_sched\_param), INTENT(IN)

### Result Type and Attributes

INTEGER(4)

### Result Value

On successful completion, this function returns 0. Otherwise, this function returns one of the following errors

#### EINVAL

The argument **thread** or **param** is invalid.

#### ENOSYS

The POSIX priority scheduling option is not implemented on AIX.

**ENOTSUP**

The value of argument **policy** or **param** is not supported.

**EPERM**

The target thread is not permitted to perform the operation or is in a mutex protocol already.

**ESRCH**

The target thread does not exist or is invalid.

**f\_thread\_setspecific(key, arg)****Purpose**

This function can be used to set the calling thread's specific data associated with the key identified by argument **key**. The argument **arg**, which is optional, identifies the thread-specific data to be set. If **arg** is not provided, the thread-specific data will be set to NULL, which is the initial value for each thread. Only an Integer pointer can be passed as the **arg** argument. If **arg** is not an Integer pointer, the result is undefined.

The actual argument **arg** must be a variable, and consequently eligible as a left-value in an assignment statement. If you pass an array section with vector subscripts to the argument **arg**, the result is unpredictable.

**Class**

Function

**Argument Type and Attributes**

**key** TYPE(f\_thread\_key\_t), INTENT(IN)

**arg** Integer pointer, INTENT(IN), OPTIONAL

**Result Type and Attributes**

INTEGER(4)

**Result Value**

On successful completion, this function returns 0. Otherwise, this function returns one of the following errors

**EINVAL**

The argument **key** is invalid.

**ENOMEM**

There is insufficient memory to associate the data with the key.

**f\_thread\_t****Purpose**

A derived data type whose components are all private. Any object of this type should be manipulated only through the appropriate interfaces provided in this module.

This data type corresponds to the POSIX **pthread\_t**, which is the type of thread object.

## **Class**

Data Type

## **f\_pthread\_testcancel()**

### **Purpose**

This subroutine provides a cancelation point in a thread. When this subroutine is called, any pending cancelation request will be acted upon immediately if the cancelability state of the thread is in the enabled state.

## **Class**

Subroutine

### **Argument Type and Attributes**

None

### **Result Type and Attributes**

None

## **f\_sched\_param**

### **Purpose**

This data type corresponds to the AIX system data structure **sched\_param**, which is a system data type. See AIX Operating System information for further details.

This is a public data structure defined as:

```
type f_sched_param
  sequence
  integer sched_priority
end type f_sched_param
```

## **Class**

Data Type

## **f\_sched\_yield()**

### **Purpose**

This function is used to force the calling thread to relinquish the processor until it again becomes the head of its thread list.

## **Class**

Function

### **Argument Type and Attributes**

None.

## Result Type and Attributes

INTEGER(4)

## Result Value

If this function completes successfully, value 0 is returned. Otherwise, a value of -1 will be returned.

## **f\_timespec**

### Purpose

This is a Fortran definition of the AIX system data structure **timespec**. Within the Fortran Pthreads module, objects of this type are used to specify an absolute date and time. This *deadline absolute date* is used when waiting on a POSIX condition variable.

In 32-bit mode, **f\_timespec** is defined as:

```
TYPE F_Timespec
  SEQUENCE
  INTEGER(4) tv_sec
  INTEGER(KIND=REGISTER_SIZE) tv_nsec
END TYPE F_Timespec
```

In 64-bit mode, **f\_timespec** is defined as:

```
TYPE F_Timespec
  SEQUENCE
  INTEGER(4) tv_sec
  INTEGER(4) pad
  INTEGER(KIND=REGISTER_SIZE) tv_nsec
END TYPE F_Timespec
```

See AIX Operating System information for further details.

### Class

Data Type



---

## Chapter 9. Interlanguage calls

Your Fortran application can perform interlanguage calls to routines written in a language other than Fortran.

The guidelines assume that you are familiar with the syntax of all applicable languages.

---

### Conventions for XL Fortran external names

To assist you in writing mixed-language programs, XL Fortran follows a consistent set of rules when translating the name of a global entity into an external name that the linker can resolve.

The rules are:

- Both the underscore (`_`) and the dollar sign (`$`) are valid characters anywhere in names.

Because names that begin with an underscore are reserved for the names of library routines, do not use an underscore as the first character of a Fortran external name.

To avoid conflicts between Fortran and non-Fortran function names, you can compile the Fortran program with the `-qextname` option. This option adds an underscore to the end of the Fortran names. Then use an underscore as the last character of any non-Fortran procedures that you want to call from Fortran.

- Names can be up to 250 characters long.
- Program and symbolic names are interpreted as all lowercase by default. If you are writing new non-Fortran code, use all-lowercase procedure names to simplify calling the procedures from Fortran.

You can use the `-U` option or the `@PROCESS MIXED` directive if you want the names to use both uppercase and lowercase:

```
@process mixed
  external C_Func      ! With MIXED, we can call C_Func, not just c_func.
  integer aBC, ABC    ! With MIXED, these are different variables.
  common /xYz/ aBc    ! The same applies to the common block names.
  common /XYZ/ ABC    ! xYz and XYZ are external names that are
                    ! visible during linking.
end
```

- Names for module procedures are formed by concatenating `__` (two underscores), the module name, `_IMOD_` (for intrinsic modules) or `_NMOD_` (for non-intrinsic modules), and the name of the module procedure. For example, module procedure `MYPROC` in module `MYMOD` has the external name `__mymod_NMOD_myproc`.

**Note:** Symbolic debuggers and other tools should account for this naming scheme when debugging XL Fortran programs that contain module procedures. For example, some debuggers default to lowercase for program and symbolic names. This behavior should be changed to use mixed case when debugging XL Fortran programs with module procedures.

- The XL compilers generate code that uses `main` as an external entry point name. You can only use `main` as an external name in these contexts:

- A Fortran program or local-variable name. (This restriction means that you cannot use `main` as a binding label, or for the name of an external function, external subroutine, block data program unit, or common block. References to such an object use the compiler-generated `main` instead of your own.)
- The name of the top-level main function in a C program.
- Some other potential naming conflicts may occur when linking a program. For instructions on avoiding them, see *Linking new objects with existing ones and Avoiding naming conflicts during linking* in the *XL Fortran Compiler Reference*.

If you are porting your application from another system and your application does encounter naming conflicts like these, you may need to use the `-qextname` option. Or you can use the `-brename` linker option on AIX to rename the symbol:

```
xlf90 -brename:old_name,new_name interlanguage_calls.f
```

---

## Mixed-language input and output

To improve performance, the XL Fortran runtime library has its own buffers and its own handling of these buffers. This means that mixed-language programs cannot freely mix I/O operations on the same file from the different languages.

Mixing code compiled by multiple Fortran compilers, for example `xlf` and `gfortran`, could face similar problems. The safest approach is to treat the code compiled by another Fortran compiler as non-Fortran code. To maintain data integrity in such cases:

- If the file position is not important, open and explicitly close the file within the Fortran part of the program before performing any I/O operations on that file from subprograms written in another language.
- To open a file in Fortran and manipulate the open file from another language, call the `flush_` procedure to save any buffer for that file, and then use the `getfd` procedure to find the corresponding file descriptor and pass it to the non-Fortran subprogram.

As an alternative to calling the `flush_` procedure, you can use the `buffering` runtime option to disable the buffering for I/O operations. When you specify `buffering=disable_preconn`, XL Fortran disables the buffering for preconnected units. When you specify `buffering=disable_all`, XL Fortran disables the buffering for all logical units.

**Note:** After you call `flush_` to flush the buffer for a file, do not do anything to the file from the Fortran part of the program except to close it when the non-Fortran processing is finished.

- If any XL Fortran subprograms containing `WRITE` statements are called from a non-Fortran main program, explicitly `CLOSE` the data file, or use the `flush_` subroutine in the XL Fortran subprograms to ensure that the buffers are flushed. Alternatively, you can use the `buffering` runtime option to disable buffering for I/O operations.

For more information on the `flush_` and `getfd` procedures, see the *Service and utility procedures* topic in the *XL Fortran Language Reference*. For more information on the `buffering` runtime option, see *Setting runtime options* in the *XL Fortran Compiler Reference*.

---

## Mixing Fortran and C++

When mixing Fortran and C++ in the same program, you need to invoke the C++ compiler to correctly link the final program.

Most of the information in this section applies to Fortran and languages with similar data types and naming schemes. However, to mix Fortran and C++ in the same program, you must add an extra level of indirection and pass the interlanguage calls through C wrapper functions.

Because the C++ compiler mangles the names of some C++ objects, you must use your C++ compiler's invocation command, like `xlC` or `g++`, to link the final program and include `-L` and `-l` options for the XL Fortran library directories and libraries as shown in *Linking 32-bit non-SMP object files using the ld command* and *Linking 64-bit non-SMP object files using the ld command* (in the *XL Fortran Compiler Reference*).

```
program main

integer idim, idim1

idim = 35
idim1 = 45

write(6,*) 'Inside Fortran calling first C function'
call cfun(idim)
write(6,*) 'Inside Fortran calling second C function'
call cfun1(idim1)
write(6,*) 'Exiting the Fortran program'
end
```

Figure 4. Main Fortran program that calls C++ (main1.f)

```
#include <stdio.h>
#include "cplus.h"

extern "C" void cfun(int *idim){
    printf("%%Inside C function before creating C++ Object\n");
    int i = *idim;
    junk<int*> jj = new junk<int>(10,30);
    jj->store(idim);
    jj->print();
    printf("%%Inside C function after creating C++ Object\n");
    delete jj;
    return;
}

extern "C" void cfun1(int *idim1) {
    printf("%%Inside C function cfun1 before creating C++ Object\n");
    int i = *idim1;
    temp<double> *tmp = new temp<double>(40, 50.54);
    tmp->print();
    printf("%%Inside C function after creating C++ temp object\n");
    delete tmp;
    return;
}
```

Figure 5. C wrapper functions for calling C++ (cfun.C)

```

#include <iostream.h>

template<class T> class junk {

private:
    int inter;
    T   templ_mem;
    T   stor_val;

public:
    junk(int i,T j): inter(i),templ_mem(j)
                    {cout <<"***Inside C++ constructor" << endl;}

    ~junk()          {cout <<"***Inside C++ Destructor"  << endl;}

    void store(T *val){ stor_val = *val;}

    void print(void) {cout << inter << "\t" << templ_mem ;
                      cout <<"\t" << stor_val << endl; }};

template<class T> class temp {

private:
    int internal;
    T   temp_var;

public:
    temp(int i, T j): internal(i),temp_var(j)
                    {cout <<"***Inside C++ temp Constructor" <<endl;}

    ~temp()          {cout <<"***Inside C++ temp destructor"  <<endl;}

    void print(void) {cout << internal << "\t" << temp_var << endl;}};

```

Figure 6. C++ code called from Fortran (*cplus.h*)

Compiling this program, linking it with the `xlc` command, and running it produces the following output:

```

Inside Fortran calling first C function
%Inside C function before creating C++ Object
***Inside C++ constructor
10    30    35
%Inside C function after creating C++ Object
***Inside C++ Destructor
Inside Fortran calling second C function
%Inside C function cfun1 before creating C++ Object
***Inside C++ temp Constructor
40    50.54
%Inside C function after creating C++ temp object
***Inside C++ temp destructor
Exiting the Fortran program

```

---

## Making calls to C functions work

When you pass an argument to a subprogram call, the usual Fortran convention is to pass the address of the argument. Many C functions expect arguments to be passed as values, however, not as addresses.

For these arguments, specify them as `%VAL(argument)` in the call to C, or make use of the standards-compliant `VALUE` attribute. For example:

```

MEMBLK = MALLOC(1024)    ! Wrong, passes the address of the constant
MEMBLK = MALLOC(N)      ! Wrong, passes the address of the variable

MEMBLK = MALLOC(%VAL(1024)) ! Right, passes the value 1024
MEMBLK = MALLOC(%VAL(N))   ! Right, passes the value of the variable

```

See “Passing arguments by reference or by value” on page 273 and %VAL and %REF in the *XL Fortran Language Reference* for more details.

---

## Passing data from one language to another

You need to account for corresponding data types in Fortran and C when passing data from one language to another.

The Corresponding data types in Fortran and C table shows the data types available in the XL Fortran and C languages. Further topics detail how Fortran arguments can be passed by reference to C programs. To use the Fortran Standard interoperability features, see the BIND attribute and ISO\_C\_BINDING module in the *XL Fortran Language Reference*.

## Passing arguments between languages

When calling Fortran procedures, the C routines must pass arguments as pointers to the types listed in the following table.

Table 26. Corresponding data types in Fortran and C

| XL Fortran Data Types                        | XL C/C++ Data Types                          |
|----------------------------------------------|----------------------------------------------|
| INTEGER(1), BYTE                             | signed char                                  |
| INTEGER(2)                                   | signed short                                 |
| INTEGER(4)                                   | signed int                                   |
| INTEGER(8)                                   | signed long long                             |
| REAL, REAL(4)                                | float                                        |
| REAL(8), DOUBLE PRECISION                    | double                                       |
| REAL(16)                                     | long double (see note 1)                     |
| COMPLEX, COMPLEX(4)                          | float _Complex                               |
| COMPLEX(8), DOUBLE COMPLEX                   | double _Complex                              |
| COMPLEX(16)                                  | long double _Complex (see note 1)            |
| LOGICAL(1)                                   | unsigned char                                |
| LOGICAL(2)                                   | unsigned short                               |
| LOGICAL(4)                                   | unsigned int                                 |
| LOGICAL(8)                                   | unsigned long long                           |
| CHARACTER                                    | char                                         |
| CHARACTER(n)                                 | char[n]                                      |
| Integer POINTER                              | void *                                       |
| Array                                        | array                                        |
| Sequence-derived type                        | structure (with C/C++ -qalign=packed option) |
| <b>Note:</b>                                 |                                              |
| 1. Requires C/C++ compiler -qlongdbl option. |                                              |

### Notes:

1. In interlanguage communication, it is often necessary to use the **%VAL** built-in function, or the standards-compliant **VALUE** attribute, and the **%REF** built-in function that are defined in “Passing arguments by reference or by value” on page 273.
2. C programs automatically convert float values to double and short integer values to integer when calling an unprototyped C function. Because XL Fortran does not perform a conversion on **REAL(4)** quantities passed by value, you should not pass **REAL(4)** and **INTEGER(2)** by value to a C function that you have not declared with an explicit interface.
3. The Fortran-derived type and the C structure must match in the number, data type, and length of subobjects to be compatible data types.

One or more sample programs under the directory `/opt/IBM/xlf/15.1.3/samples` illustrate how to call from Fortran to C.

To use the Fortran Standard interoperability features provided by XL Fortran, see the Language interoperability features section in the *XL Fortran Language Reference*.

## Passing global variables between languages

To access a C data structure from within a Fortran program or to access a common block from within a C program, follow these steps:

1. Create a named common block that provides a one-to-one mapping of the C structure members. If you have an unnamed common block, change it to a named one. Name the common block with the name of the C structure.
2. Declare the C structure as a global variable by putting its declaration outside any function or inside a function with the **extern** qualifier.
3. Compile the C source file with **-qalign=packed**.

```
program cstruct                                struct mystuff {
real(8) a,d                                    double a;
integer b,c                                    int b,c;
.  double d;
.  };
common /mystuff/ a,b,c,d
.
end   main() {
```

If you do not have a specific need for a named common block, you can create a sequence-derived type with the same one-to-one mapping as a C structure and pass it as an argument to a C function. You must compile the C source file with **-qalign=packed** or put **#pragmas** into the struct.

Common blocks that are declared **THREADLOCAL** are thread-specific data areas that are dynamically allocated by compiler-generated code. A static block is still reserved for a **THREADLOCAL** common block, but the compiler and the compiler's runtime environment use it for control information. If you need to share **THREADLOCAL** common blocks between Fortran and C procedures, your C source must be aware of the implementation of the **THREADLOCAL** common block. For more information, see the *Directives* section in the *XL Fortran Language Reference*, and Chapter 13, “Sample Fortran programs,” on page 333.

Common blocks that are declared **THREADPRIVATE** can be accessed using a C global variable that is declared as **THREADPRIVATE**.

## Passing character types between languages

One difficult aspect of interlanguage calls is passing character strings between languages. The difficulty is due to the following underlying differences in the way that different languages represent such entities:

- The only character type in Fortran is **CHARACTER**, which is stored as a set of contiguous bytes, one character per byte. The length is not stored as part of the entity. Instead, it is passed by value as an extra argument at the end of the declared argument list when the entity is passed as an argument. The size of the argument is 4 or 8 bytes, depending on the compilation mode used (32- or 64-bit, respectively).
- Character strings in C are stored as arrays of the type **char**. A null character indicates the end of the string.

**Note:** To have the compiler automatically add the null character to certain character arguments, you can use the **-qnullterm** option (described in the *XL Fortran Compiler Reference*).

If you are writing both parts of the mixed-language program, you can make the C routines deal with the extra Fortran length argument, or you can suppress this extra argument by passing the string using the **%REF** function. If you use **%REF**, which you typically would for pre-existing C routines, you need to indicate where the string ends by concatenating a null character to the end of each character string that is passed to a C routine:

```
! Initialize a character string to pass to C.
      character*6 message1 /'Hello\0'/
! Initialize a character string as usual, and append the null later.
      character*5 message2 /'world'/

! Pass both strings to a C function that takes 2 (char *) arguments.
      call cfunc(%ref(message1), %ref(message2 // '\0'))
      end
```

For compatibility with C language usage, you can encode the following escape sequences in XL Fortran character strings:

Table 27. Escape sequences for character strings

| Escape | Meaning                                                                     |
|--------|-----------------------------------------------------------------------------|
| \b     | Backspace                                                                   |
| \f     | Form feed                                                                   |
| \n     | New-line                                                                    |
| \t     | Tab                                                                         |
| \0     | Null                                                                        |
| \'     | Apostrophe (does not terminate a string)                                    |
| \"     | Double quotation mark (does not terminate a string)                         |
| \\     | Backslash                                                                   |
| \x     | <i>x</i> , where <i>x</i> is any other character (the backslash is ignored) |

If you do not want the backslash interpreted as an escape character within strings, you can compile with the **-qnoescape** option.

## Passing arrays between languages

Fortran stores array elements in ascending storage units in column-major order. C stores array elements in row-major order. Fortran array indexes start at 1, while C array indexes start at 0.

The following example shows how a two-dimensional array that is declared by A(3,2) is stored in Fortran and C.

*Table 28. Corresponding array layouts for Fortran and C.* The Fortran array reference A(X,Y,Z) can be expressed in C as a[Z-1][Y-1][X-1]. Keep in mind that although C passes individual scalar array elements by value, it passes arrays by reference.

|                      | Fortran Element Name | C Element Name |
|----------------------|----------------------|----------------|
| Lowest storage unit  | A(1,1)               | A[0][0]        |
|                      | A(2,1)               | A[0][1]        |
|                      | A(3,1)               | A[1][0]        |
|                      | A(1,2)               | A[1][1]        |
|                      | A(2,2)               | A[2][0]        |
| Highest storage unit | A(3,2)               | A[2][1]        |

To pass all or part of a Fortran array to another language, you can use Fortran 90/Fortran 95 array notation:

```
REAL, DIMENSION(4,8) :: A, B(10)
```

```
! Pass an entire 4 x 8 array.
CALL CFUNC( A )
! Pass only the upper-left quadrant of the array.
CALL CFUNC( A(1:2,1:4) )
! Pass an array consisting of every third element of A.
CALL CFUNC( A(1:4:3,1:8) )
! Pass a 1-dimensional array consisting of elements 1, 2, and 4 of B.
CALL CFUNC( B( (/1,2,4/) ) )
```

Where necessary, the Fortran program constructs a temporary array and copies all the elements into contiguous storage. In all cases, the C routine needs to account for the column-major layout of the array.

Any array section or noncontiguous array is passed as the address of a contiguous temporary unless an explicit interface exists where the corresponding dummy argument is declared as an assumed-shape array or a pointer. To avoid the creation of array descriptors (which are not supported for interlanguage calls) when calling non-Fortran procedures with array arguments, either do not give the non-Fortran procedures any explicit interface, or do not declare the corresponding dummy arguments as assumed-shape or pointers in the interface:

```
! This explicit interface must be changed before the C function
! can be called.
INTERFACE
  FUNCTION CFUNC (ARRAY, PTR1, PTR2)
    INTEGER, DIMENSION (:) :: ARRAY      ! Change this : to *.
    INTEGER, POINTER, DIMENSION (:) :: PTR1 ! Change this : to *
   ! and remove the POINTER
   ! attribute.
    REAL, POINTER :: PTR2                ! Remove this POINTER
   ! attribute or change to TARGET.
  END FUNCTION
END INTERFACE
```



## Passing pointers between languages

Integer **POINTERS** always represent the address of the pointee object and must be passed by value:

```
CALL CFUNC(%VAL(INTPTR))
```

Note that the FORTRAN 77 **POINTER** extension from XL Fortran Version 2 is now referred to as “integer **POINTER**” to distinguish it from the Fortran 90 meaning of **POINTER**.

Fortran 90 **POINTERS** can also be passed back and forth between languages but only if there is no explicit interface for the called procedure or if the argument in the explicit interface does not have a **POINTER** attribute or assumed-shape declarator. You can remove any **POINTER** attribute or change it to **TARGET** and can change any deferred-shape array declarator to be explicit-shape or assumed-size.

Because of XL Fortran's call-by-reference conventions, you must pass even scalar values from another language as the address of the value, rather than the value itself. For example, a C function passing an integer value *x* to Fortran must pass `&x`. Also, a C function passing a pointer value *p* to Fortran so that Fortran can use it as an integer **POINTER** must declare it as `void **p`. A C array is an exception: you can pass it to Fortran without the `&` operator.

## Passing arguments by reference or by value

To call subprograms written in languages other than Fortran (for example, user-written C programs, or operating system routines), the actual arguments may need to be passed by a method different from the default method used by Fortran. C routines, including those in system libraries, such as **libc.a**, require you to pass arguments by value instead of by reference. (Although C passes individual scalar array elements by value, it passes arrays by reference.)

You can change the default passing method by using the **%VAL** built-in function or **VALUE** attribute and the **%REF** built-in function in the argument list of a **CALL** statement or function reference. You cannot use them in the argument lists of Fortran procedure references or with alternate return specifiers.

**%REF** Passes an argument by reference (that is, the called subprogram receives the address of the argument). It is the same as the default calling method for Fortran except that it also suppresses the extra length argument for character strings.

**%VAL** Passes an argument by value (that is, the called subprogram receives an argument that has the same value as the actual argument, but any change to this argument does not affect the actual argument).

You can use this built-in function with actual arguments that are **CHARACTER(1)**, **BYTE**, logical, integer, real, or complex expressions or that are sequence-derived type. Objects of derived type cannot contain pointers, arrays, or character structure components whose lengths are greater than one byte.

You cannot use **%VAL** with actual arguments that are array entities, procedure names, or character expressions of length greater than one byte.

**%VAL** causes XL Fortran to pass the actual argument as 32-bit or 64-bit intermediate values.

### 32-bit intermediate values

If the actual argument is one of the following:

- An integer or a logical that is shorter than 32 bits, it is sign-extended to a 32-bit value.
- An integer or a logical that is longer than 32 bits, it is passed as two 32-bit intermediate values.
- Of type real or complex, it is passed as multiple 32-bit intermediate values.
- Of sequence-derived type, it is passed as multiple 32-bit intermediate values.

Byte-named constants and variables are passed as if they were **INTEGER(1)**. If the actual argument is a **CHARACTER(1)**, the compiler pads it on the left with zeros to a 32-bit value, regardless of whether you specified the **-qctyplss** compiler option.

#### 64-bit intermediate values

If the actual argument is one of the following:

- An integer or a logical that is shorter than 64 bits, it is sign-extended to a 64-bit value.
- Of type real or complex, it is passed as multiple 64-bit intermediate values.
- Of sequence-derived type, it is passed as multiple 64-bit intermediate values.

Byte-named constants and variables are passed as if they were **INTEGER(1)**. If the actual argument is a **CHARACTER(1)**, the compiler pads it on the left with zeros to a 64-bit value, regardless of whether you specified the **-qctyplss** compiler option.

If you specify the **-qautodbl** compiler option, any padded storage space is not passed except for objects of derived type.

#### VALUE attribute

Specifies an argument association between a dummy and an actual argument that allows you to pass the dummy argument with the value of the actual argument. Changes to the value or definition status of the dummy argument do not affect the actual argument.

You must specify the **VALUE** attribute for dummy arguments only.

You must not use the **%VAL** or **%REF** built-in functions to reference a dummy argument with the **VALUE** attribute, or the associated actual argument.

A referenced procedure that has a dummy argument with the **VALUE** attribute must have an explicit interface.

You must not specify the **VALUE** attribute with the following:

- Arrays
- Derived types with **ALLOCATABLE** components
- Dummy procedures

```
EXTERNAL FUNC  
COMPLEX XVAR  
IVARB=6
```

```

CALL RIGHT2(%REF(FUNC))      ! procedure name passed by reference
CALL RIGHT3(%VAL(XVAR))     ! complex argument passed by value
CALL TPROG(%VAL(IVARB))     ! integer argument passed by value
END

```

## Explicit interface for %VAL and %REF

You can specify an explicit interface for non-Fortran procedures to avoid coding calls to %VAL and %REF in each argument list, as follows:

```

INTERFACE
  FUNCTION C_FUNC(%VAL(A),%VAL(B)) ! Now you can code "c_func(a,b)"
    INTEGER A,B                    ! instead of
  END FUNCTION C_FUNC              ! "c_func(%val(a),%val(b))".
END INTERFACE

```

## Example with VALUE attribute

```

Program validexm1
  integer :: x = 10, y = 20
  print *, 'before calling: ', x, y
  call intersub(x, y)
  print *, 'after calling: ', x, y

  contains
  subroutine intersub(x,y)
    integer, value :: x
    integer y
    x = x + y
    y = x*y
    print *, 'in subroutine after changing: ', x, y
  end subroutine
end program validexm1

```

Expected output:

```

before calling: 10 20
in subroutine after changing: 30 600
after calling: 10 600

```

## Returning values from Fortran functions

XL Fortran does not support calling certain types of Fortran functions from non-Fortran procedures. If a Fortran function returns a pointer, array, or character of nonconstant length, do not call it from outside Fortran.

You can call such a function indirectly:

```

SUBROUTINE MAT2(A,B,C)      ! You can call this subroutine from C, and the
                           ! result is stored in C.
INTEGER, DIMENSION(10,10) :: A,B,C
C = ARRAY_FUNC(A,B)        ! But you could not call ARRAY_FUNC directly.
END

```

## Arguments with the OPTIONAL attribute

When you pass an optional argument by reference, the address in the argument list is zero if the argument is not present.

When you pass an optional argument by value, the value is zero if the argument is not present. The compiler uses an extra register argument to differentiate that value from a regular zero value. If the register has the value 1, the optional argument is present; if it has the value 0, the optional argument is not present.

**Related information:**

“Order of arguments in argument list” on page 287

## Type encoding and checking

Runtime errors are hard to find, and many of them are caused by mismatched procedure interfaces or conflicting data definitions. Therefore, it is a good idea to find as many of these problems as possible at compile or link time. To store type information in the object file so that the linker can detect mismatches, use the `-qextchk` compiler option.

---

## Assembler-level subroutine linkage conventions

The subroutine linkage convention specifies the machine state at subroutine entry and exit, allowing routines that are compiled separately in the same or different languages to be linked.

The information on subroutine linkage and system calls in the *AIX Commands Reference, Volumes 1 - 6* is the base reference on this topic. You should consult it for full details. This section summarizes the information needed to write mixed-language Fortran and assembler programs or to debug at the assembler level, where you need to be concerned with these kinds of low-level details.

The system linkage convention passes arguments in registers, taking full advantage of the large number of floating-point registers (FPRs), general-purpose registers (GPRs), vector registers (VRs and VSRs) and minimizing the saving and restoring of registers on subroutine entry and exit. The linkage convention allows for argument passing and return values to be in registers (FPRs, GPRs, VRs or multiple register types), memory, or both.

The following table lists floating-point registers and their functions. The floating-point registers are double precision (64 bits).

*Table 29. Floating-point register usage across calls*

| Register | Preserved Across Calls | Use                                |
|----------|------------------------|------------------------------------|
| 0        | no                     |                                    |
| 1        | no                     | FP parameter 1, function return 1. |
| 2        | no                     | FP parameter 2, function return 2. |
| 3        | no                     | FP parameter 3, function return 3. |
| 4        | no                     | FP parameter 4, function return 4. |
| 5        | no                     | FP parameter 5                     |
| :        | :                      | :                                  |
| :        | :                      | :                                  |
| 13       | no                     | FP parameter 13                    |
| 14-31    | yes                    |                                    |

The following table lists general-purpose registers and their functions.

*Table 30. General-purpose register usage across calls*

| Register | Preserved Across Calls | Use                                   |
|----------|------------------------|---------------------------------------|
| 0        | no                     |                                       |
| 1        | yes                    | Stack pointer.                        |
| 2        | yes                    | TOC pointer.                          |
| 3        | no                     | 1st word of arg list; return value 1. |

Table 30. General-purpose register usage across calls (continued)

| Register                                                                                                                                                                                                                                                                                                                                                        | Preserved Across Calls | Use                                      |
|-----------------------------------------------------------------------------------------------------------------------------------------------------------------------------------------------------------------------------------------------------------------------------------------------------------------------------------------------------------------|------------------------|------------------------------------------|
| 4                                                                                                                                                                                                                                                                                                                                                               | no                     | 2nd word of arg list; return value 2.    |
| ⋮                                                                                                                                                                                                                                                                                                                                                               | ⋮                      | ⋮                                        |
| 10                                                                                                                                                                                                                                                                                                                                                              | no                     | 8th word of arg list; return value 8.    |
| 11                                                                                                                                                                                                                                                                                                                                                              | no                     | DSA pointer to internal procedure (Env). |
| 12                                                                                                                                                                                                                                                                                                                                                              | no                     |                                          |
| 13                                                                                                                                                                                                                                                                                                                                                              | yes                    | Thread Local pointer in 64-bit mode.     |
| 14-31                                                                                                                                                                                                                                                                                                                                                           | yes                    |                                          |
| If a register is not designated as preserved, its contents may be changed during the call, and the caller is responsible for saving any registers whose values are needed later. Conversely, if a register is supposed to be preserved, the callee is responsible for preserving its contents across the call, and the caller does not need any special action. |                        |                                          |

The following table lists vector register conventions.

Table 31. VMX Vector register usage across calls

| Register                                                                                                                                                 | Preserved Across Calls | Use                               |
|----------------------------------------------------------------------------------------------------------------------------------------------------------|------------------------|-----------------------------------|
| 0                                                                                                                                                        | no                     | Local variables                   |
| 1                                                                                                                                                        | no                     | Local variables                   |
| 2                                                                                                                                                        | no                     | Vector parameter 1, vector result |
| 3                                                                                                                                                        | no                     | Vector parameter 2                |
| 4                                                                                                                                                        | no                     | Vector parameter 3                |
| 5                                                                                                                                                        | no                     | Vector parameter 4                |
| 6                                                                                                                                                        | no                     | Vector parameter 5                |
| 7                                                                                                                                                        | no                     | Vector parameter 6                |
| 8                                                                                                                                                        | no                     | Vector parameter 7                |
| 9                                                                                                                                                        | no                     | Vector parameter 8                |
| 10-19                                                                                                                                                    | no                     | Local variables                   |
| 20-31                                                                                                                                                    | controlled by option   | Local variables                   |
| VMX vector registers VR0-31 correspond to VSX registers 32-63. FPR floating-point registers FP0-31 correspond to the upper halves of VSX registers 0-31. |                        |                                   |

The following table lists special-purpose register conventions.

Table 32. Special-purpose register usage across calls

| Register                                                                                        | Preserved Across Calls |
|-------------------------------------------------------------------------------------------------|------------------------|
| Condition register<br>Bits 0-7 (CR0,CR1)<br>Bits 8-22 (CR2,CR3,CR4)<br>Bits 23-31 (CR5,CR6,CR7) | no<br>yes<br>no        |
| Link register                                                                                   | no                     |
| Count register                                                                                  | no                     |

Table 32. Special-purpose register usage across calls (continued)

| Register       | Preserved Across Calls                                                                                                               |
|----------------|--------------------------------------------------------------------------------------------------------------------------------------|
| XER register   | no                                                                                                                                   |
| FPSCR register | The control flags are preserved except for calls to functions whose purposes are to change them. The status flags are not preserved. |

## The stack

The stack is a portion of storage that is used to hold local storage, register save areas, parameter lists, and call-chain data. The stack grows from higher addresses to lower addresses. A stack pointer register (register 1) is used to mark the current “top” of the stack.

A stack frame is the portion of the stack that is used by a single procedure. In either case, the stack frame size is best defined as the difference between the caller's stack pointer and the callee's.

The following diagrams show the storage maps of typical stack frames for 32-bit and 64-bit environments.

In these diagrams, the current routine has acquired a stack frame that allows it to call other functions. If the routine does not make any calls and there are no local variables or temporaries, the function need not allocate a stack frame. It can use the register save area at the top of where the callee's stack frame would have been, if needed.

The stack frame is quadword aligned. The FPR save area (which must contain an even number of FPRs), the VR save area and the parameter area (P1, P2, ..., Pn) are quadword aligned. In 64-bit mode the GPR save area is doubleword aligned. Other areas require word alignment only.

The following diagram shows the storage map of a typical stack frame for a 32-bit environment.

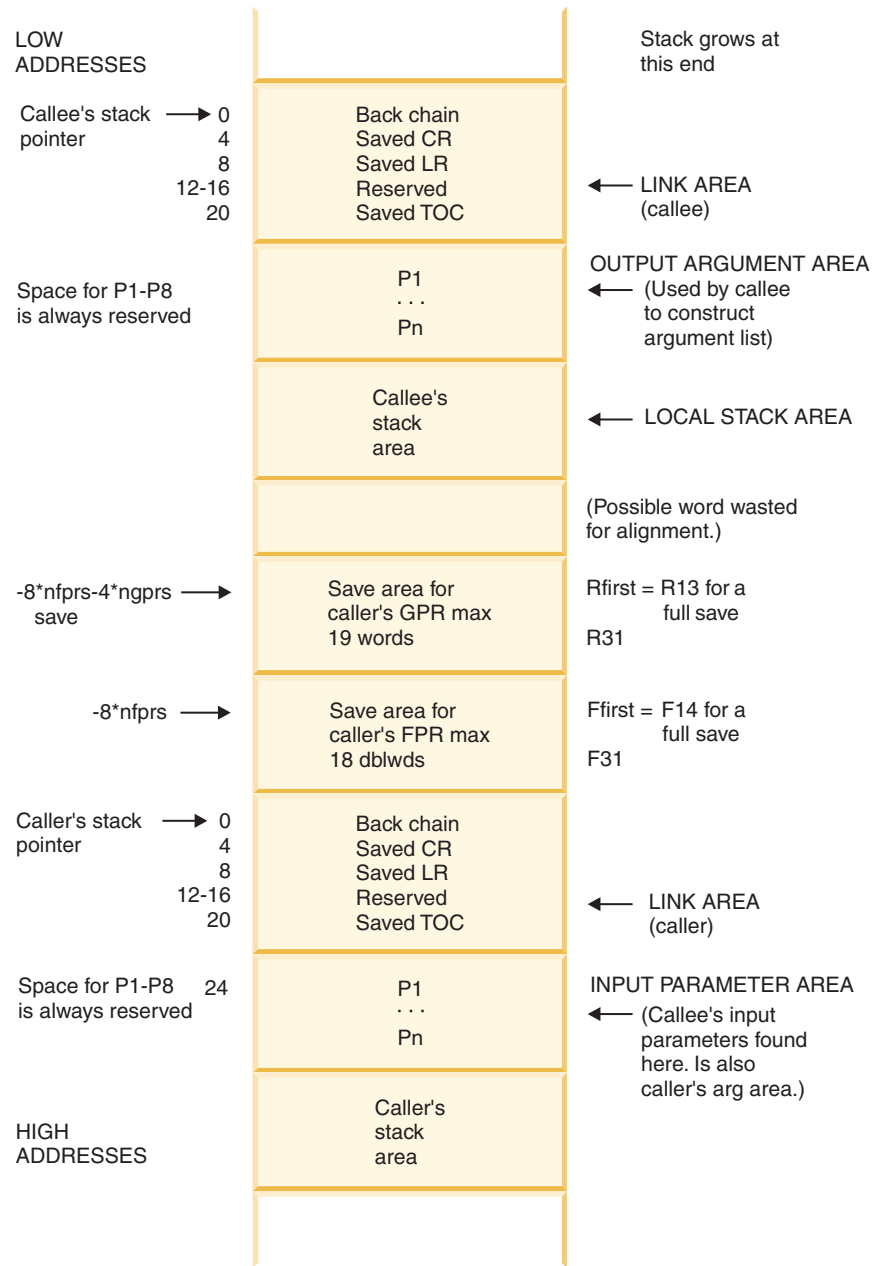

Figure 7. Runtime Stack for 32-bit Environment - Vector Information not Included

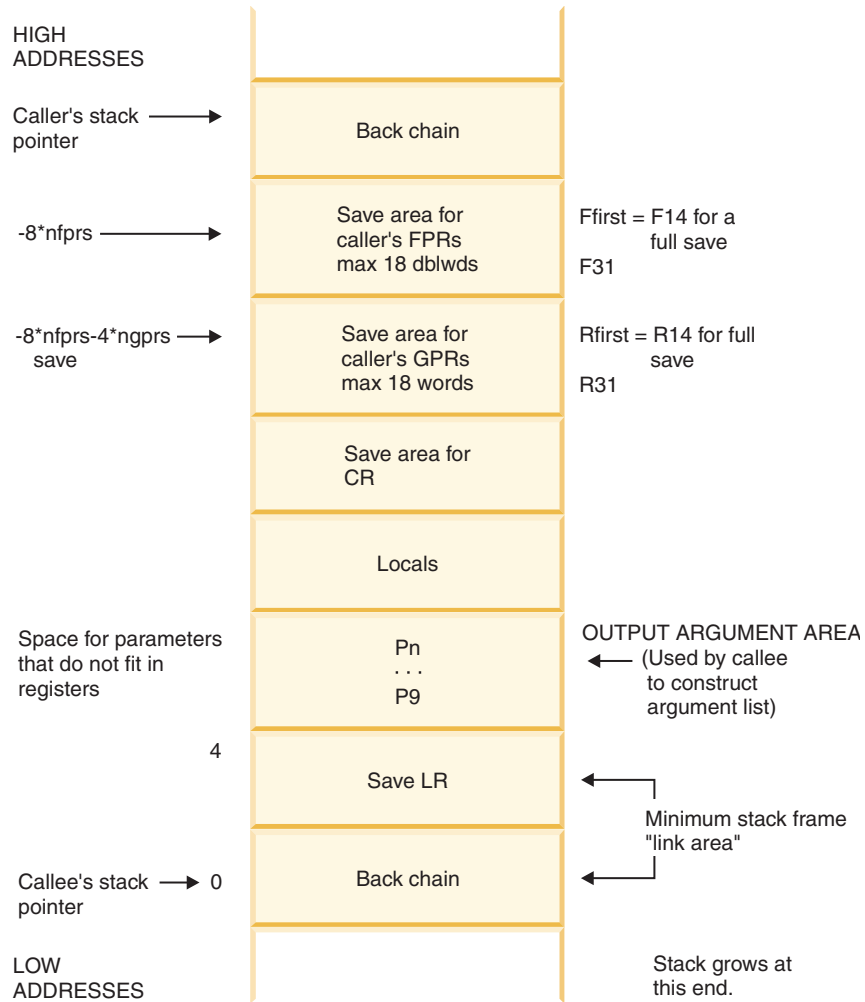

Figure 8. Runtime Stack for 32-bit Environment

The following diagram shows the storage map of a typical stack frame for a 64-bit environment.



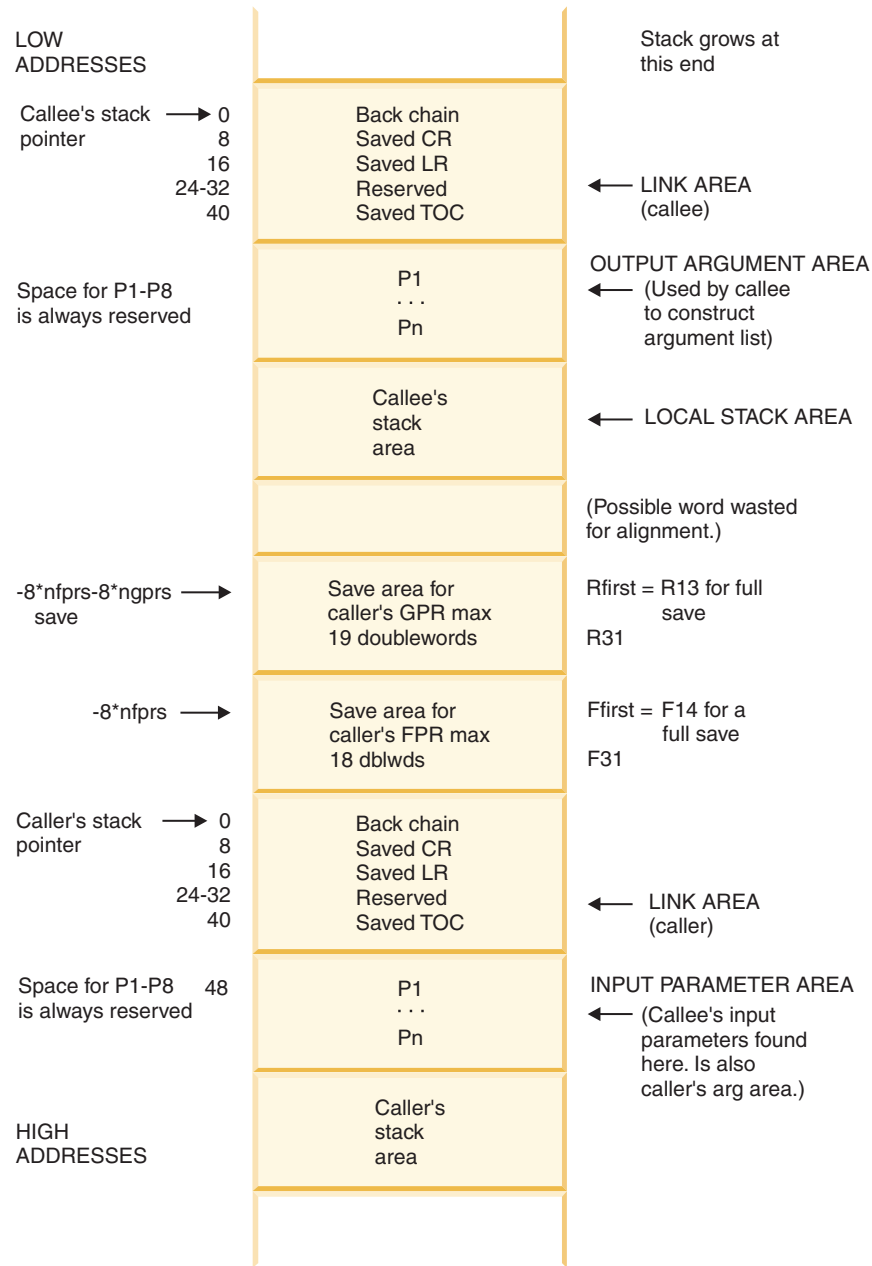

Figure 9. Runtime Stack for 64-bit Environment

## The Linkage Area

In a 32-bit environment, the linkage area consists of six words at offset zero from the caller's stack pointer on entry to a procedure. The first word contains the caller's back chain (stack pointer). The second word is the location where the callee saves the Condition Register (CR) if it is needed. The third word is the location where the callee's prolog code saves the Link Register if it is needed. The fourth and fifth words are reserved for future use. The last word (word 6) is reserved for use by the global linkage routines that are used when calling routines in other object modules (for example, in shared libraries) to save the caller's TOC pointer.

In a 64-bit environment, the linkage area consists of six doublewords at offset zero from the caller's stack pointer on entry to a procedure. The first doubleword contains the caller's back chain (stack pointer). The second doubleword is the location where the callee saves the Condition Register (CR) if it is needed. The third doubleword is the location where the callee's prolog code saves the Link Register if it is needed. The fourth and fifth doublewords are reserved for future use. The last doubleword (doubleword 6) is reserved for use by the global linkage routines that are used when calling routines in other object modules (for example, in shared libraries) to save the caller's TOC pointer.

## The input parameter area

In a 32-bit environment, the input parameter area is a contiguous piece of storage reserved by the calling program to represent the register image of the input parameters of the callee. The input parameter area is double-word aligned and is located on the stack directly following the caller's link area. This area is at least 8 words in size. If more than 8 words of parameters are expected, they are stored as register images that start at positive offset 56 from the incoming stack pointer.

The first 8 words only appear in registers at the call point, never in the stack. Remaining words are always in the stack, and they can also be in registers.

In a 64-bit environment, the input parameter area is a contiguous piece of storage reserved by the calling program to represent the register image of the input parameters of the callee. The input parameter area is quadword aligned and is located on the stack directly following the caller's link area. This area is at least 8 doublewords in size. If more than 8 doublewords of parameters are passed, they are stored as register images that start at positive offset 112 from the caller's stack pointer.

The first 8 doublewords only appear in registers at the call point, never in the stack. Remaining words are always in the stack.

## The register save area

In a 32-bit environment, the register save area provides the space that is needed to save all nonvolatile FPRs and GPRs used by the callee program. The FPRs are saved next to caller's minimum stack frame. The GPRs are saved below the FPRs (in lower addresses).

In a 64-bit environment, the register save area is doubleword aligned for GPRs and FPRs and quadword aligned for VRs. It provides the space that is needed to save all nonvolatile FPRs, GPRs and VRs used by the callee program. The FPRs are saved next to the link area. The FPRs are saved at the highest addresses of the stack frame. The GPRs are saved just below (in lower addresses than) the FPRs. The VRs are saved just below (in lower addresses than) the GPRs. The called function may save the registers here even if it does not need to allocate a new stack frame. The system-defined stack floor includes the maximum possible save area:

32-bit platforms: 18\*8 for FPRs + 19\*4 for GPRs + 12\*16 for VRs  
64-bit platforms: 18\*8 for FPRs + 19\*8 for GPRs + 12\*16 for VRs

Locations at a numerically lower address than the stack floor should not be accessed.

For each register type, a callee needs only to save the nonvolatile registers starting with the lowest that it actually uses, up to the highest register number; for

example, using r27 and r31 means that r27 to r31 must be saved. It always saves register 31 in the highest addressed word (in a 32-bit environment) or doubleword (in a 64-bit environment).

## The local stack area

The local stack area is the space that is allocated by the callee procedure for local variables and temporaries.

## The output parameter area

The output parameter area (P1...Pn) must be large enough to hold the largest parameter list of all procedures that the procedure that owns this stack frame calls.

In a 32-bit environment, this area is at least 8 words long, regardless of the length or existence of any argument list. If more than 8 words are being passed, an extension list is constructed beginning at offset 56 from the current stack pointer. The first 8 words only appear in registers at the call point, never in the stack. Remaining words are always in the stack, and they can also be in registers.

In a 64-bit environment, this area is at least 8 doublewords long, regardless of the length or existence of any argument list. If more than 8 doublewords are being passed, an extension list is constructed, which begins at offset 112 from the current stack pointer.

The first 8 doublewords only appear in registers at the call point, never in the stack. Remaining doublewords are always in the stack, and they can also be in registers.

---

## Linkage convention for argument passing

The system linkage convention takes advantage of the large number of registers available.

The linkage convention passes arguments in GPRs, FPRs and VRs. Three fixed lists, R3-R10, FP1-FP13 and VR2-VR10, specify the GPRs, FPRs and VRs available.

When there are more argument words than available argument GPRs, FPRs and VRs, the remaining words are passed in storage on the stack. The values in storage are the same values as if they were in registers but are in memory format while values in registers might be in a different format. Here are some examples. A single precision floating-point is in double precision format when in an FPR but in single precision format when in memory or passed in a GPR. A small struct may be right justified when in a GPR but left justified in memory. A vector may have its element order reversed when in a VR.

In a 64-bit environment, the size of the parameter area is sufficient to contain all the arguments passed on any call statement from the procedure that is associated with the stack frame. Although not all the arguments for a particular call actually appear in storage, it is convenient to consider them as forming a list in this area, each one occupying one or more words.

For call by reference (as is the default for Fortran), the address of the argument is passed in a register. The following information refers to call by value, as in C or as in Fortran when %VAL is used. For purposes of their appearance in the list, arguments are classified as floating-point values, vector values or general values:

## In a 32-bit Environment

- Each **INTEGER(8)** and **LOGICAL(8)** argument requires two words.
- Any other non-floating-point scalar argument of intrinsic type requires one word and appears in that word exactly as it would appear in a GPR. It is right-justified, if language semantics specify, and is word aligned.
- Each single-precision (**REAL(4)**) value occupies one word. Each double-precision (**REAL(8)**) value occupies two successive words in the list. Each extended-precision (**REAL(16)**) value occupies four successive words in the list.
- A **COMPLEX** value occupies twice as many words as a **REAL** value with the same kind type parameter.
- A **VECTOR** value occupies four words (16 bytes) in a vector register.
- In Fortran and C, structure values appear in successive words as they would anywhere in storage, satisfying all appropriate alignment requirements. Structures are aligned to a fullword and occupy  $(\text{sizeof}(\text{struct } X)+3)/4$  fullwords, with any padding at the end. A structure that is smaller than a word is left-justified within its word or register. Larger structures can occupy multiple registers and may be passed partly in storage and partly in registers.
- Other aggregate values are passed “val-by-ref”. That is, the compiler actually passes their address and arranges for a copy to be made in the invoked program.
- A procedure or function pointer is passed as a pointer to the routine's function descriptor; its first word contains its entry point address. See “Pointers to functions” on page 287 for more information.

## In a 64-bit environment

- All general values require one doubleword that is doubleword aligned.
- Each single-precision (**REAL(4)**) value and each double-precision (**REAL(8)**) value occupies one doubleword in the list. Each extended-precision (**REAL(16)**) value occupies two successive doublewords in the list.
- A **COMPLEX** value occupies twice as many doublewords as a **REAL** value with the same kind type parameter.
- A **VECTOR** value occupies four words (16 bytes) in a vector register
- In Fortran and C, structure values appear in successive words as they would anywhere in storage, satisfying all appropriate alignment requirements. Structures are aligned to a doubleword and occupy  $(\text{sizeof}(\text{struct } X)+7)/8$  doublewords, with any padding at the end. A structure that is smaller than a doubleword is left-justified within its doubleword or register. Larger structures can occupy multiple registers and may be passed partly in storage and partly in registers.
- Other aggregate values are passed “val-by-ref”. That is, the compiler actually passes their address and arranges for a copy to be made in the invoked program.
- A procedure or function pointer is passed as a pointer to the routine's function descriptor; its first word contains its entry point address. See “Pointers to functions” on page 287 for more information.

## Argument passing rules (by value)

In a 64-bit environment, from the following illustration, we state these rules:

- In a 32-bit environment, the parameter list is a conceptually contiguous piece of storage that contains a list of words. For efficiency, the first 8 words of the list are not actually stored in the space that is reserved for them but are passed in

GPR3-GPR10. Further, the first 13 floating-point value parameters are passed in FPR1-FPR13. Those beyond the first 8 words of the parameter list are also in storage. Those within the first 8 words of the parameter list have GPRs reserved for them, but they are not used.

- In a 32-bit environment, arguments to called functions are passed in the GPRs and FPRs. Up to eight words are passed in GPR3-GPR10 and up to eight floating-point arguments in FPR1-FPR8. If fewer arguments are passed, unneeded registers are not loaded. If the passed arguments will not fit in registers, only enough space to hold the arguments that do not fit is allocated in the stack frame.
- In a 64-bit environment, the preceding information holds true if references to words are replaced with doublewords.
- In a 64-bit environment, if the called procedure treats the parameter list as a contiguous piece of storage (for example, if the address of a parameter is taken in C), the parameter registers are stored in the space reserved for them in the stack.
- A register image is stored on the stack, except as described in section “Linkage convention for argument passing” on page 283.
- In a 64-bit environment, the argument area ( $P_1 \dots P_n$ ) must be large enough to hold the largest parameter list.

Here is an example of a call to a function :

```
f(%val(l1), %val(l2), %val(l3), %val(d1), %val(f1),  
  %val(c1), %val(d2), %val(s1), %val(cx2))
```

where:

l denotes integer(4) (fullword integer)

d denotes real(8) (double precision)

f denotes real(4) (real)

s denotes integer(2) (halfword integer)

c denotes character (one character)

cx denotes complex(8) (double complex)

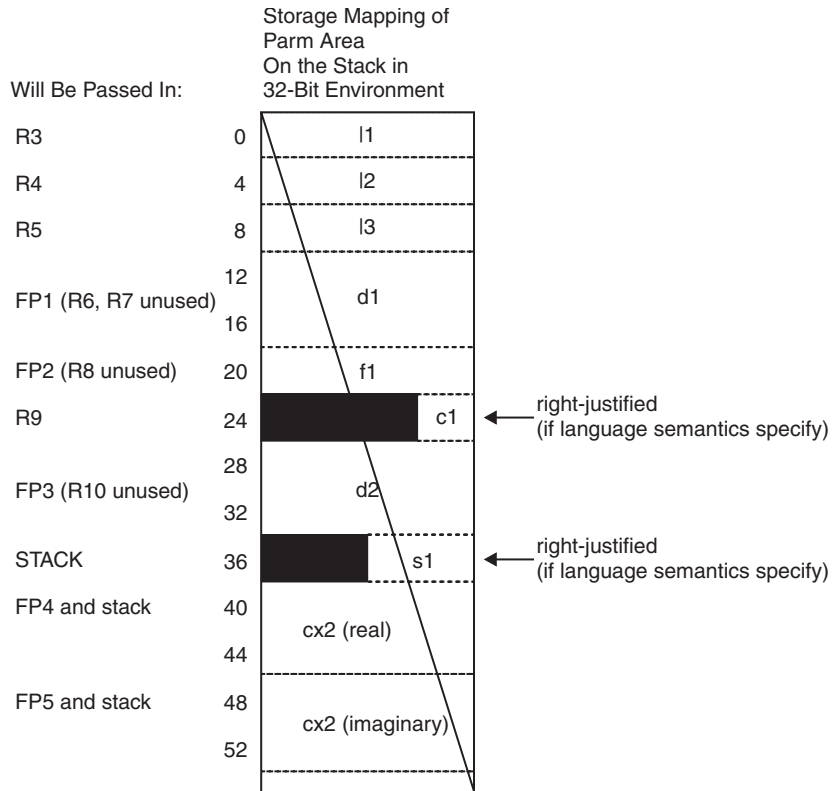

Figure 10. Storage mapping of parm area on the stack in 32-bit environment

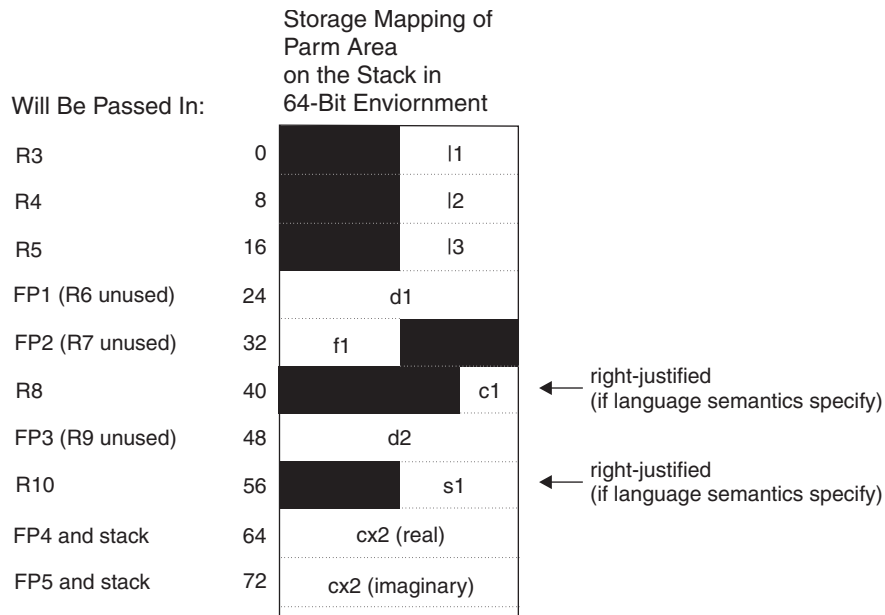

Figure 11. Storage mapping of parm area on the stack in 64-bit environment

## Order of arguments in argument list

The argument list is constructed in the following order. Items in the same bullet appear in the same order as in the procedure declaration, whether or not argument keywords are used in the call.

- All addresses or values (or both) of actual arguments <sup>1</sup>
- “Present” indicators for optional arguments
- Length arguments for strings <sup>1</sup>

---

## Linkage convention for function calls

Function calls to a routine make use of its function descriptor and entry point symbols.

A routine has two symbols associated with it: a function descriptor (*name*) and an entry point (*.name*). When a call is made to a routine, the program branches to the entry point directly. Excluding the loading of parameters (if any) in the proper registers, compilers expand calls to functions to one or in general both of the following two-instruction sequence. The special NOP is needed only if the called routine might need a new TOC pointer loaded.

```
BL    .foo                # Branch to foo
ORI  R0,R0,0x0000        # Special NOP
```

The linker does one of two things when it encounters a **BL** instruction:

1. If `foo` is imported (not in the same object module) and inline glue code has not been generated, the linker changes the **BL** to `.foo` to a **BL** to `.glink` (global linkage routine) of `foo` and inserts the `.glink` into the object module. Also, if a **NOP** instruction (`ORI R0,R0,0x0000`) immediately follows the **BL** instruction, the linker replaces the **NOP** instruction with the **LOAD** instruction `L R2, 20(R1)` for 32-bit mode, `L R2, 40(R1)` for 64-bit mode.
2. If `foo` is bound in the same object module as its caller and a **LOAD** instruction above, or `ORI R0,R0,0` immediately follows the **BL** instruction, the linker replaces the **LOAD** instruction with a **NOP** (`ORI R0,R0,0`).

**Note:** For any export, the linker inserts the procedure's descriptor into the object module.

## Pointers to functions

A function pointer is a data type whose values range over procedure names. Variables of this type appear in several programming languages, such as C and Fortran. In Fortran, a dummy argument that appears in an **EXTERNAL** statement is a function pointer. Fortran provides support for the use of function pointers in contexts such as the target of a call statement or an actual argument of such a statement.

A function pointer is a fullword or doubleword quantity that is the address of a function descriptor. The function descriptor is a 3 word or 3 doubleword object. The first word or doubleword contains the address of the entry point of the procedure. The second has the address of the TOC of the object module in which the procedure is bound. The third is the environment pointer for nested (contained) procedures. There is only one function descriptor per entry point. It is

---

1. There may be other items in this list during Fortran-Fortran calls. However, they will not be visible to non-Fortran procedures that follow the calling rules in this section.

bound into the same object module as the function it identifies if the function is external. The descriptor has an external name, which is the same as the function name but with a different storage class that uniquely identifies it. This descriptor name is used in all import or export operations.

In 32-bit mode, function pointers are 4 bytes long and contain a 32-bit address. In 64-bit mode, they are 8 bytes long and contain a 64-bit address. For pointers to local functions, the address contained is the address of the function in the text section. For imported functions, the address is that of the function's stub. Every unique, imported function will have a stub in the object. The function stub is in the non-lazy symbol pointer section.

## Function values

Functions return their values according to type:

- In 32-bit mode, **INTEGER** and **LOGICAL** of kind 1, 2, and 4 are returned (sign/zero extended) in R3.
- In 64-bit mode, **INTEGER** and **LOGICAL** of kind 1, 2, and 4 are returned (sign/zero extended) in R3.
- In 64-bit mode, **INTEGER** and **LOGICAL** of kind 8 are returned in R3.
- **REAL** of kind 4 or 8 are returned in FP1. **REAL** of kind 16 are returned in FP1 and FP2.
- **COMPLEX** of kind 4 or 8 are returned in FP1 and FP2. **COMPLEX** of kind 16 are returned in FP1-FP4.
- Vector results are returned in VR2
- Character strings are returned in a buffer allocated by the caller. The address and the length of this buffer are passed in R3 and R4 as hidden parameters. The first explicit parameter doubleword is in R5, and all subsequent parameters are moved to the next doubleword.
- Structures are returned in a buffer that is allocated by the caller. The address is passed in R3; there is no length. The first explicit parameter is in R4.

## The stack floor

Stack floor is a system-defined address below which the stack cannot grow. All programs in the system must avoid accessing locations in the stack segment that are below the stack floor.

All programs must maintain other system invariants that are related to the stack:

- The stack pointer must always be quadword (16 byte) aligned.
- No data is saved or accessed from an address lower than the stack floor, except that locations within a small distance below the stack frame may be accessed before the stack is allocated or after it is deallocated, or without it ever being allocated.
- The stack pointer is always valid. You must take care to ensure that the stack pointer is changed in a single instruction. When allocating a new stack frame, the old stack pointer must be saved at the beginning of the new stack frame by that same instruction. When an allocation is of more than 32,767 bytes, an index register must be used instead of an immediate operand. This step ensures that there is no timing window where a signal handler would either overlay the stack data or erroneously appear to overflow the stack segment.



## Stack overflow

The linkage convention requires no explicit inline check for overflow. The operating system uses a storage protection mechanism to detect stores past the end of the stack segment.

---

## Prolog and epilog

You need to consider a number of steps when entering a procedure and when exiting a procedure.

On entry to a procedure, you might have to do some or all of the following steps:

1. Save the link register at offset 8 for 32-bit environments (or offset 16 for 64-bit environments) from the stack pointer if necessary.
2. If the procedure uses any of the CR bits 8-23 (CR2, CR3, CR4), save the CR at displacement 4 for 32-bit environments (or displacement 8 for 64-bit environments) from the current stack pointer.
3. Save all nonvolatile FPRs that are used by this procedure in the caller's FPR save area. You can use a set of routines: `_savef14`, `_savef15`, ... `_savef31`.
4. Save all nonvolatile VRs that are used by this procedure in the VR save area.
5. Save all nonvolatile GPRs that are used by this procedure in the caller's GPR save area.
6. Atomically store the back chain and decrease the stack pointer by the size of the stack frame. Note that if a stack overflow occurs, it will be known immediately when the store of the back chain is done.

On exit from a procedure, you might have to perform some or all of the following steps:

1. Restore all GPRs saved that have been modified.
2. Restore all FPRs saved that have been modified.
3. Restore all VRs saved that have been modified.
4. Restore bits 8-23 of the CR (CR2, CR3, CR4) if they were used, if necessary.
5. Atomically restore the stack pointer to the value it had on entry.
6. Return to caller.

---

## Traceback

XL Fortran supports the traceback mechanism, which symbolic debuggers need to unravel the call or return stack. Each object module has a traceback table in the text segment at the end of its code. This table contains information about the object module, including the type of object module, as well as stack frame and register information.

**Note:** You can make the traceback table smaller or remove it entirely with the `-qtbtable` option.



---

## Chapter 10. Implementation details of XL Fortran Input/Output (I/O)

This topic describes XL Fortran support (through extensions and platform-specific details) for the AIX file system.

See “Mixed-language input and output” on page 266 for further considerations related to input and output operations.

---

### Implementation details of file formats

The manner in which XL Fortran implements files is based on their file format.

#### Sequential-access unformatted files:

An integer that contains the length of the record precedes and follows each record. The length of the integer is 4 bytes for 32-bit applications. For 64-bit applications, the length of the integer is 4 bytes if you set the **uwidth** runtime option to 32 (the default), and 8 bytes if you set the **uwidth** runtime option to 64.

#### Sequential-access formatted files:

XL Fortran programs break these files into records while reading, by using each newline character (X'0A') as a record separator.

On output, the input/output system writes a newline character at the end of each record. Programs can also write newline characters for themselves. This practice is not recommended because the effect is that the single record that appears to be written is treated as more than one record when being read or backspaced over.

#### Direct access files:

XL Fortran simulates direct-access files with operating system files whose length is a multiple of the record length of the XL Fortran file. You must specify, in an **OPEN** statement, the record length (**RECL**) of the direct-access file. XL Fortran uses this record length to distinguish records from each other.

For example, the third record of a direct-access file of record length 100 bytes would start at the 201st byte of the single record of an AIX file and end at the 300th byte.

If the length of the record of a direct-access file is greater than the total amount of data you want to write to the record, XL Fortran pads the record on the right with blanks (X'20').

#### Stream-access unformatted files:

Unformatted stream files are viewed as a collection of file storage units. In XL Fortran, a file storage unit is one byte.

A file connected for unformatted stream access has the following properties:

- The first file storage unit has position 1. Each subsequent file storage unit has a position that is one greater than that of the preceding one.
- For a file that can be positioned, file storage units need not be read or written in the order of their position. Any file storage unit may be read from the file while it is connected to a unit, provided that the file

storage unit has been written since the file was created, and if a READ statement for the connection is permitted.

#### Stream-access formatted files:

A record file connected for formatted stream access has the following properties:

- Some file storage units may represent record markers. The record marker is the newline character (X'0A').
- The file will have a record structure in addition to the stream structure.
- The record structure is inferred from the record markers that are stored in the file.
- Records can have any length up to the internal limit allowed by XL Fortran (See *XL Fortran Internal limits* in the *XL Fortran Compiler Reference*.)
- There may or may not be a record marker at the end of the file. If there is no record marker at the end of the file, the final record is incomplete, but not empty.

A file connected for formatted stream access has the following properties:

- The first file storage unit has position 1. Each subsequent file storage unit has a position that is greater than that of the preceding one. Unlike unformatted stream access, the positions of successive file storage units are not always consecutive.
- The position of a file connected for formatted stream access can be determined by the **POS=** specifier in an **INQUIRE** statement.
- For a file that can be positioned, the file position can be set to a value that was previously identified by the **POS=** specifier in **INQUIRE**.

#### Related information

- The **XLFRTIOPTS** environment variable

---

## File names

There are a number of considerations to be aware of when working with file names.

You can specify file names as either relative (such as **file**, **dir/file**, or **./file**) or absolute (such as **/file** or **/dir/file**). The maximum length of a file name (the full path name) is 1023 characters, even if you only specify a relative path name in the I/O statement. The maximum length of a file name with no path is 255 characters.

You must specify a valid file name in such places as the following:

- The **FILE=** specifier of the **OPEN** and **INQUIRE** statements
- **INCLUDE** lines

**Note:** To specify a file whose location depends on an environment variable, you can use the **GET\_ENVIRONMENT\_VARIABLE** intrinsic procedure to retrieve the value of the environment variable:

```
character(100) home, name
call get_environment_variable('HOME', value=home)
! Now home = $HOME + blank padding.
! Construct the complete path name and open the file.
name=trim(home) // '/remainder/of/path'
open (unit=10, file=name)
...
end
```

---

## Preconnected and Implicitly Connected Files

Whether files are preconnected or implicitly connected is dependent on their units and specific statements.

Units 0, 5, and 6 are preconnected to standard error, standard input, and standard output, respectively, before the program runs.

All other units can be implicitly connected when an **ENDFILE**, **PRINT**, **READ**, **REWIND**, or **WRITE** statement is performed on a unit that has not been opened. Unit *n* is implicitly connected to a file that is named **fort.n**. These files need not exist, and XL Fortran does not create them unless you use the corresponding units implicitly.

**Note:** Because unit 0 is preconnected for standard error, you cannot use it for the **CLOSE**, **ENDFILE**, **BACKSPACE**, or **REWIND** statements with sequential input/output. You cannot use unit 0 for direct or stream input/output. You can use unit 0 in an **OPEN** statement only to change the values of the **BLANK=**, **DELIM=**, **DECIMAL=** or **PAD=** specifiers.

You can also implicitly connect units 5 and 6 (and \*) by using I/O statements that follow a **CLOSE** of these units:

```
        WRITE (6,10) "This message goes to stdout."  
        CLOSE (6)  
        WRITE (6,10) "This message goes in the file fort.6."  
        PRINT *, "Output to * now also goes in fort.6."  
10     FORMAT (A)  
      END
```

The **FORM=** specifier of implicitly connected files has the value **FORMATTED** before any **READ**, **WRITE**, or **PRINT** statement is performed on the unit. The first such statement on such a file determines the **FORM=** specifier from that point on: **FORMATTED** if the formatting of the statement is format-directed, list-directed, or namelist; and **UNFORMATTED** if the statement is unformatted.

Preconnected files also have **FORM='FORMATTED'**, **STATUS='OLD'**, and **ACTION='READWRITE'** as default specifier values.

The other properties of a preconnected or implicitly connected file are the default specifier values for the **OPEN** statement. These files always use sequential access.

If you want XL Fortran to use your own file instead of the **fort.n** file, you can either specify your file for that unit through an **OPEN** statement or create a symbolic link before running the application. In the following example, there is a symbolic link between **myfile** and **fort.10**:

```
ln -s myfile fort.10
```

When you run an application that uses the implicitly connected file **fort.10** for input/output, XL Fortran uses the file **myfile** instead. The file **fort.10** exists, but only as a symbolic link. The following command will remove the symbolic link, but will not affect the existence of **myfile**:

```
rm fort.10
```

## File positioning

The position of a file pointer when a file is opened with no **POSITION=** specifier is summarized in the following table.

Table 33. Position of the file pointer when a file is opened with no **POSITION=** specifier

| -qposition suboptions       | Implicit OPEN |                     | Explicit OPEN  |                     |                              |                     |                    |                     |
|-----------------------------|---------------|---------------------|----------------|---------------------|------------------------------|---------------------|--------------------|---------------------|
|                             |               |                     | STATUS = 'NEW' |                     | STATUS = 'OLD'               |                     | STATUS = 'UNKNOWN' |                     |
|                             | File exists   | File does not exist | File exists    | File does not exist | File exists                  | File does not exist | File exists        | File does not exist |
| option not specified        | Start         | Start               | Error          | Start               | Start<br><b>1</b> , <b>3</b> | Error               | Start              | Start               |
| appendold <b>2</b>          | Start         | Start               | Error          | Start               | End                          | Error               | Start              | Start               |
| appendunknown               | Start         | Start               | Error          | Start               | Start<br><b>3</b>            | Error               | End                | Start               |
| appendold and appendunknown | Start         | Start               | Error          | Start               | End                          | Error               | End                | Start               |

The important things to note are:

- **1** The behavior of commands like `xlF90`, `xlF95`, `xlF2003`, or `xlF2008` when you do not specify an option is different from XL Fortran Version 2.3 in this case. Fortran standards since Fortran 90 require this behavior. To minimize migration problems, the `xlF`, `xlF_r`, `xlF_r7`, `f77`, and `fort77` commands keep the same default as XL Fortran Version 2.3 and append to the end of the file.  
**Attention:** If your program depends on the old behavior to append to the end of an existing file with **STATUS='OLD'**, you need to use the option **-qposition=appendold** or **POSITION=** specifiers when making the switch to a command like `xlF90`, `xlF95`, `xlF2003`, or `xlF2008`. Otherwise, when you compile the program with these commands and run it, the new data will overwrite the file instead of appending to it.
- **2** **-qposition=appendold** produces the default XL Fortran Version 2.3 behavior for positioning the file pointer. This option is in the configuration-file stanza for the `xlF`, `xlF_r`, `xlF_r7`, `f77`, and `fort77` commands but is not in the configuration-file stanza for the commands like `xlF90`, `xlF95`, `xlF2003`, and `xlF2008`.
- **3** This file position was not possible in XL Fortran Version 2.3.

## Preserving the XL Fortran Version 2.3 file positioning

If you are upgrading from XL Fortran Version 2.3 and want the file positioning to work the same way as before, note the following guidelines:

- If you continue to use the `f77` and `fort77` commands, you do not need to make any changes. You also do not need to make any changes if you use the `xlF`, `xlF_r`, and `xlF_r7` commands to compile `.f`, `.F`, `.f77`, or `.F77` files.
- When you make the transition to the commands like `xlF90`, `xlF95`, `xlF2003`, and `xlF2008`:
  - Add **-qposition=appendold** for programs that were previously compiled without any **-qposition** option.
  - Add **-qposition=appendold:appendunknown** for programs that were previously compiled with **-qposition=append**.

---

## I/O redirection

You can use the redirection operator on the command line to redirect input to and output from your XL Fortran program.

How you specify and use this operator depends on which shell you are running. Here is a **ksh** example:

```
$ cat redirect.f
      write (6,*) 'This goes to standard output'
      write (0,*) 'This goes to standard error'
      read (5,*) i
      print *,i
      end
$ xlf95 redirect.f
** _main      === End of Compilation 1 ===
1501-510  Compilation successful for file redirect.f.
$ # No redirection. Input comes from the terminal. Output goes to
$ # the screen.
$ a.out
  This goes to standard output
  This goes to standard error
4
  4
$ # Create an input file.
$ echo >stdin 2
$ # Redirect each standard I/O stream.
$ a.out >stdout 2>stderr <stdin
$ cat stdout
  This goes to standard output
2
$ cat stderr
  This goes to standard error
```

You can refer to the following sections of the *AIX Commands Reference, Volumes 1 - 6* for more information on redirection:

- "Input and Output Redirection in the Korn Shell (ksh Command)"
- "Input and Output Redirection in the Bourne Shell (bsh Command)"
- "Input and Output Redirection in the C Shell (csh Command)"

---

## How XL Fortran I/O interacts with pipes, special files, and links

You can access regular operating system files and blocked special files by using sequential-access, direct-access, or stream-access methods.

You can only access pseudo-devices, pipes, and character special files by using sequential-access methods, or stream-access without using the **POS=** specifier.

When you use symbolic link to link files together, you can use their names interchangeably, as shown in the following example:

```
OPEN (4, FILE="file1")
OPEN (4, FILE="link_to_file1", PAD="NO") ! Modify connection
```

Do not specify the **POSITION=** specifier as **REWIND** or **APPEND** for pipes. **REWIND** is allowed for tapes, but **APPEND** is not. To open a tape file at a specific location, use the **tctl** command to position the tape before running the Fortran program, and specify **POSITION='ASIS'** in the program.

Do not specify **ACTION='READWRITE'** for a pipe.

Do not use the **BACKSPACE** statement on files that are pseudo-devices or character special files (such as tapes).

Do not use the **REWIND** statement on files that are pseudo-devices or pipes. If used on a tape, it rewinds to the beginning of the file, not the beginning of the tape.

---

## Default record lengths

The default record lengths for files is dependent on the file format and on the **RECL=** qualifier.

If a pseudo-device, pipe, or character special file is connected for formatted or unformatted sequential access with no **RECL=** qualifier, or for formatted stream access, the default record length is 32 768 rather than 2 147 483 647, which is the default for sequential-access files connected to random-access devices. (See the **default\_recl** runtime option in the *XL Fortran Compiler Reference*.)

In certain cases, the default maximum record length for formatted files is larger, to accommodate programs that write long records to standard output. If a unit is connected to a terminal for formatted sequential access and there is no explicit **RECL=** qualifier in the **OPEN** statement, the program uses a maximum record length of 2 147 483 646 ( $2^{31}-2$ ) bytes, rather than the usual default of 32 768 bytes. When the maximum record length is larger, formatted I/O has one restriction: **WRITE** statements that use the **T** or **TL** edit descriptors must not write more than 32 768 bytes. This is because the unit's internal buffer is flushed each 32 768 bytes, and the **T** or **TL** edit descriptors will not be able to move back past this boundary.

---

## File permissions

A file must have the appropriate permissions (read, write, or both) for the corresponding operation being performed on it.

When a file is created, the default permissions (if the **umask** setting is 000) are both read and write for user, group, and other. You can turn off individual permission bits by changing the **umask** setting before you run the program.

---

## Selecting error messages and recovery actions

There are various ways to control a program's behavior when errors are encountered.

By default, an XL Fortran-compiled program continues after encountering many kinds of errors, even if the statements have no **ERR=** or **IOSTAT=** specifiers. The program performs some action that might allow it to recover successfully from the bad data or other problem.

To control the behavior of a program that encounters errors, set the **XLFRTSEOPTS** environment variable, which is described in *Setting runtime options* in the *XL Fortran Compiler Reference*, before running the program:

- To make the program stop when it encounters an error instead of performing a recovery action, include **err\_recovery=no** in the **XLFRTSEOPTS** setting.



- To make the program stop issuing messages each time it encounters an error, include **xrf\_messages=no**.
- To disallow XL Fortran extensions to Fortran 90 at run time, include **langlvl=90std**. To disallow XL Fortran extensions to Fortran 95 at run time, include **langlvl=95std**. To disallow XL Fortran extensions to Fortran 2003 behavior at run time, include **langlvl=2003std**. To disallow XL Fortran extensions to Fortran 2008 behavior at run time, include **langlvl=2008std**. These settings, in conjunction with the **-qlanglvl** compiler option, can help you locate extensions when preparing to port a program to another platform.

For example:

```
# Switch defaults for some runtime settings.
XLFRT_OPTS="err_recovery=no:cnvrr=no"
export XLFRT_OPTS
```

If you want a program always to work the same way, regardless of environment-variable settings, or want to change the behavior in different parts of the program, you can call the **SETRT\_OPTS** procedure:

```
PROGRAM RT_OPTS
USE XLFUTILITY
CALL SETRT_OPTS("err_recovery=no") ! Change setting.
... some I/O statements ...
CALL SETRT_OPTS("err_recovery=yes") ! Change it back.
... some more I/O statements ...
END
```

Because a user can change these settings through the **XLFRT\_OPTS** environment variable, be sure to use **SETRT\_OPTS** to set all the runtime options that might affect the wanted operation of the program.

---

## Flushing I/O buffers

To protect data from being lost if a program ends unexpectedly, you can use the **FLUSH** statement or the **flush\_** subroutine to write any buffered data to a file.

The **FLUSH** statement is recommended for better portability and is used in the following example:

```
INTEGER, PARAMETER :: UNIT = 10
DO I = 1, 1000000
  WRITE(UNIT, *) I
  CALL MIGHT_CRASH
  ! If the program ends in the middle of the loop, some data
  ! may be lost.
END DO
DO I = 1, 1000000
  WRITE(UNIT, *) I
  FLUSH(UNIT)
  CALL MIGHT_CRASH
  ! If the program ends in the middle of the loop, all data written
  ! up to that point will be safely in the file.
END DO
END
```

### Related information:

“Mixed-language input and output” on page 266



See **FLUSH** in the Compiler Reference

---

## Choosing locations and names for Input/Output files

If you need to override the default locations and names for input/output files, you can use the following methods without making any changes to the source code.

### Naming files that are connected with no explicit name

To give a specific name to a file that would usually have a name of the form **fort.unit**, you must set the runtime option **unit\_vars** and then set an environment variable with a name of the form **XLFUNIT\_unit** for each scratch file. The association is between a unit number in the Fortran program and a path name in the file system.

For example, suppose that the Fortran program contains the following statements:

```
OPEN (UNIT=1, FORM='FORMATTED', ACCESS='SEQUENTIAL', RECL=1024)
...
OPEN (UNIT=12, FORM='UNFORMATTED', ACCESS='DIRECT', RECL=131072)
...
OPEN (UNIT=123, FORM='UNFORMATTED', ACCESS='SEQUENTIAL', RECL=997)
XLFRT_OPTS="unit_vars=yes"      # Allow overriding default names.
XLFUNIT_1="/tmp/molecules.dat"  # Use this named file.
XLFUNIT_12="./data/scratch"     # Relative to current directory.
XLFUNIT_123="/home/user/data/Users/username/data" # Somewhere besides /tmp.
export XLFRT_OPTS XLFUNIT_1 XLFUNIT_12 XLFUNIT_123
```

#### Notes:

1. The **XLFUNIT\_number** variable name must be in uppercase, and *number* must not have any leading zeros.
2. **unit\_vars=yes** might be only part of the value for the **XLFRT\_OPTS** variable, depending on what other runtime options you have set. See *Setting runtime options* in the *XL Fortran Compiler Reference* for other options that might be part of the **XLFRT\_OPTS** value.
3. If the **unit\_vars** runtime option is set to **no** or is undefined or if the applicable **XLFUNIT\_number** variable is not set when the program is run, the program uses a default name (**fort.unit**) for the file and puts it in the current directory.

### Naming scratch files

To place all scratch files in a particular directory, set the **TMPDIR** environment variable to the name of the directory. The program then opens the scratch files in this directory. You might need to do this if your **/tmp** directory is too small to hold the scratch files.

To give a specific name to a scratch file, you must do the following:

1. Set the runtime option **scratch\_vars**.
2. Set an environment variable with a name of the form **XLFSCRATCH\_unit** for each scratch file.

The association is between a unit number in the Fortran program and a path name in the file system. In this case, the **TMPDIR** variable does not affect the location of the scratch file.

For example, suppose that the Fortran program contains the following statements:

```
OPEN (UNIT=1, STATUS='SCRATCH', &
      FORM='FORMATTED', ACCESS='SEQUENTIAL', RECL=1024)
...
OPEN (UNIT=12, STATUS='SCRATCH', &
      FORM='UNFORMATTED', ACCESS='DIRECT', RECL=131072)
```

```

...
OPEN (UNIT=123, STATUS='SCRATCH', &
      FORM='UNFORMATTED', ACCESS='SEQUENTIAL', RECL=997)
XLFRTFOPTS="scratch_vars=yes"      # Turn on scratch file naming.
XLFSCRATCH_1="/tmp/molecules.dat"  # Use this named file.
XLFSCRATCH_12="./data/scratch"     # Relative to current directory.
XLFSCRATCH_123="/home/user/data/Users/username/data" # Somewhere besides /tmp.
export XLFRTFOPTS XLFSCRATCH_1 XLFSCRATCH_12 XLFSCRATCH_123

```

**Notes:**

1. The **XLFSCRATCH\_number** variable name must be in uppercase, and *number* must not have any leading zeros.
2. **scratch\_vars=yes** might be only part of the value for the **XLFRTFOPTS** variable, depending on what other runtime options you have set. See *Setting runtime options* in the *XL Fortran Compiler Reference* for other options that might be part of the **XLFRTFOPTS** value.
3. If the **scratch\_vars** runtime option is set to **no** or is undefined or if the applicable **XLFSCRATCH\_number** variable is not set when the program is run, the program chooses a unique file name for the scratch file and puts it in the directory named by the **TMPDIR** variable or in the **/tmp** directory if the **TMPDIR** variable is not set.

---

## Increasing throughput with logical volume I/O and data striping

For performance-critical applications, the overhead of the Journaled File System (JFS) for I/O operations might slow down the program. If your program generates large scratch files, you might find that I/O bandwidth also limits its performance. Performing I/O directly to a logical volume rather than to a file system can eliminate the JFS overhead. Using data striping on the logical volume can further improve throughput or processor utilization or both.

Because data-striped I/O runs much faster for data items that are aligned more strictly than normal, ensure that variables involved in logical volume I/O or data striping are properly aligned. You can do this by using the **-qalign** option or the **ALIGN** directive.

### Logical volume I/O

To use a logical volume as a file, do the following:

- Set up the logical volume with permissions that allow you to read or write it.
- Specify the name of the special file (for example, **/dev/rlv99**) in the **OPEN** statement

**Attention:** Do not perform this kind of I/O with any logical volume that already contains a file system; doing so will destroy the file system. You must also take any precautions necessary to ensure that multiple users or programs do not write to the same logical volume or write to a logical volume while someone else is reading from it.

**Note:**

1. A logical volume can only be opened as a single direct-access file with a record length that is a multiple of the logical volume's sector size (usually 512 bytes).
2. I/O operations are not guaranteed to detect attempts to read or write past the end of the logical volume. Therefore, make sure that the program keeps track of the extent of the logical volume. The maximum amount of data that can be

stored this way on logical volume is the size of the logical volume minus the size of one stripe. The XL Fortran I/O routines use this stripe for bookkeeping.

3. For optimal performance of data striping, ensure that any data items that you specified in the read or write lists for a logical volume are aligned on 64-byte boundaries. The simplest way to ensure this alignment for large static arrays and common blocks is to specify the option `-qalign=4k`.
4. Regardless of any `STATUS='SCRATCH'` or `STATUS='DELETE'` specifiers, neither the data in a logical volume nor the special file in `/dev` is destroyed by an `OPEN` or `CLOSE` statement.

**Related reference:**



See the `-qalign` option in the Compiler Reference

## Data striping

Data striping is primarily useful for increasing I/O throughput for large, direct-access scratch files. The performance benefit is greatest when a program reads and writes large objects.

When you make use of data striping, you perform I/O to a logical volume as described in “Logical volume I/O” on page 299 and set up the logical volume especially for high-performance striped I/O through the `smit` or `mklv` commands. You can then use the technique that is described in “Naming scratch files” on page 298 to place a scratch file on a striped logical volume.

For example, consider a Fortran program that contains the following statements:

```
OPEN (UNIT=42, STATUS='SCRATCH',
+     FORM='UNFORMATTED', ACCESS='DIRECT', RECL=131072)
...
OPEN (UNIT=101, STATUS='SCRATCH',
+     FORM='UNFORMATTED', ACCESS='DIRECT', RECL=131072)
```

You could place the scratch files for units 42 and 101 on the raw logical volumes `/dev/rlv30` and `/dev/rlv31` by setting environment variables before running the program, as follows:

```
XLFRTEOPTS="scratch_vars=yes"
XLFSCRATCH_42="/dev/rlv30"
XLFSCRATCH_101="/dev/rlv31"
export XLFRTEOPTS XLFSCRATCH_42 XLFSCRATCH_101
```

*AIX Performance Management* discusses the performance of data striping.

---

## Asynchronous I/O

You may need to use asynchronous I/O for speed and efficiency in scientific programs that perform I/O for large amounts of data. Synchronous I/O blocks the execution of an application until the I/O operation completes. Asynchronous I/O allows an application to continue processing while the I/O operation is performed in the background.

You can modify applications to take advantage of the ability to overlap processing and I/O operations. Multiple asynchronous I/O operations can also be performed simultaneously. For a complete description of the syntax and language elements that you require to use this feature, see the following topics in the *XL Fortran Language Reference* :

- **INQUIRE** Statement

- **OPEN** Statement
- **READ** Statement
- **WAIT** Statement
- **WRITE** Statement

## Execution of an asynchronous data transfer operation

The effect of executing an asynchronous data transfer operation will be as if the following steps were performed in the order specified, with steps (6)-(9) possibly occurring asynchronously:

1. Determine the direction of the data transfer.
2. Identify the unit.
3. Establish the format if one is present.
4. Determine whether an error condition, end-of-file condition, or end-of-record condition has occurred.
5. Cause the variable that you specified in the **IOSTAT=** specifier in the data transfer statement to become defined.
6. Position the file before you transfer data.
7. Transfer data between the file and the entities that you specified by the input/output list (if any).
8. Determine whether an error condition, end-of-file condition, or end-of-record condition has occurred.
9. Position the file after you transfer data.
10. Cause any variables that you specified in the **IOSTAT=** and **SIZE=** specifiers in the **WAIT** statement to become defined.

## Usage

You can use Fortran asynchronous **READ** and **WRITE** statements to initiate asynchronous data transfers in Fortran. Execution continues after the asynchronous I/O statement, regardless of whether the actual data transfer has completed.

A program may synchronize itself with a previously initiated asynchronous I/O statement by using a **WAIT** statement. There are two forms of the **WAIT** statement:

1. In a **WAIT** statement without the **DONE=** specifier, the **WAIT** statement halts execution until the corresponding asynchronous I/O statement has completed:

```
integer idvar
integer, dimension(1000):: a
....
READ(unit_number, ID=idvar) a
....
WAIT(ID=idvar)
....
```

2. In a **WAIT** statement with the **DONE=** specifier, the **WAIT** statement returns the completion status of an asynchronous I/O statement:

```
integer idvar
logical done
integer, dimension(1000):: a
....
READ(unit_number, ID=idvar) a
....
WAIT(ID=idvar, DONE=done)
....
```

The variable you specified in the **DONE=** specifier is set to "true" if the corresponding asynchronous I/O statement completes. Otherwise, it is set to "false".

The actual data transfer can take place in the following cases:

- During the asynchronous **READ** or **WRITE** statement
- At any time before the execution of the corresponding **WAIT** statement
- During the corresponding **WAIT** statement

Because of the nature of asynchronous I/O, the actual completion time of the request cannot be predicted.

You can specify asynchronous **READ** and **WRITE** statements by using the **ID=** specifier. The value set for the **ID=** specifier by an asynchronous **READ** or **WRITE** statement must be the same value specified in the **ID=** specifier in the corresponding **WAIT** statement. You must preserve this value until the associated asynchronous I/O statement has completed.

The following program shows a valid asynchronous **WRITE** statement:

```
program sample0
  integer, dimension(1000):: a
  integer idvar
  a = (/i,i=1,1000/)
  WRITE(10,ID=idvar) a
  WAIT(ID=idvar)
end
```

The following program is not valid, because the value of the asynchronous I/O identifier in variable *idvar* is destroyed before the associated **WAIT** statement:

```
program sample1
  integer, dimension(1000):: a
  integer idvar
  a = (/i,i=1,1000/)
  WRITE(10,ID=idvar) a
  idvar = 999      ! Valid id is destroyed.
  WAIT(ID=idvar)
end
```

An application that uses asynchronous I/O typically improves performance by overlapping processing with I/O operations. The following is a simple example:

```
program sample2
  integer (kind=4), parameter :: isize=1000000, icol=5
  integer (kind=4) :: i, j, k
  integer (kind=4), dimension(icol) :: handle
  integer (kind=4), dimension(isize,icol), static :: a, a1

!
!   Opens the file for both synchronous and asynchronous I/O.
!
  open(20,form="unformatted",access="direct", &
       status="scratch", recl=isize*4,asynch="yes")

!
!   This loop overlaps the initialization of a(:,j) with
!   asynchronous write statements.
!
!   NOTE: The array is written out one column at a time.
!         Since the arrays in Fortran are arranged in column
!         major order, each WRITE statement writes out a
!         contiguous block of the array.
!
```

```

do 200 j = 1, icol
  a(:,j) = (/ (i*j,i=1, isize) /)
  write(20, id=handle(j), rec=j) a(:,j)
200 end do

!
! Wait for all writes to complete before reading.
!
do 300 j = 1, icol
  wait(id=handle(j))
300 end do

!
! Reads in the first record.
!
read(20, id=handle(1), rec=1) a1(:,1)

do 400 j = 2, icol
  k = j - 1
!
! Waits for a previously initiated read to complete.
!
  wait(id=handle(k))
!
! Initiates the next read immediately.
!
  read(20, id=handle(j), rec=j) a1(:,j)
!
! While the next read is going on, we do some processing here.
!
  do 350 i = 1, isize
    if (a(i,k) .ne. a1(i,k)) then
      print *, "(",i,",",k,") &
        & expected ", a(i,k), " got ", a1(i,k)
    end if
350   end do
400 end do

!
! Finish the last record.
!
  wait(id=handle(icol))

do 450 i = 1, isize
  if (a(i,icol) .ne. a1(i,icol)) then
    print *, "(",i,",",icol,") &
      & expected ", a(i,icol), " got ", a1(i,icol)
  end if
450 end do

close(20)
end

```

## Performance

To maximize the benefits of asynchronous I/O, you should only use it for large contiguous data items.

It is possible to perform asynchronous I/O on a large number of small items, but the overall performance will suffer. This is because extra processing overhead is required to maintain each item for asynchronous I/O. Performing asynchronous I/O on a larger number of small items is strongly discouraged. The following are two examples:

1. WRITE(unit\_number, ID=idvar) a1(1:10000000:2)
2. WRITE(unit\_number, ID=idvar) (a2(i,j),j=1,10000000)

Performing asynchronous I/O on unformatted sequential files is less efficient. This is because each record might have a different length, and these lengths are stored with the records themselves. You should use unformatted direct access or unformatted stream access, if possible, to maximize the benefits of asynchronous I/O.

## Compiler-generated temporary I/O items

There are situations when the compiler must generate a temporary variable to hold the result of an I/O item expression. In such cases, synchronous I/O is performed on the temporary variable, regardless of the mode of transfer that you specified in the I/O statement. The following are examples of such cases:

1. For **READ**, when an array with vector subscripts appears as an input item:

a.

```
integer a(5), b(3)
b = (/1,3,5/)
read(99, id=i) a(b)
```

b.

```
real a(10)
read(99, id=i) a(/1,3,5/)
```

2. For **WRITE**, when an output item is an expression that is a constant or a constant of certain derived types:

a.

```
write(99, id=i) 1000
```

b.

```
integer a
parameter(a=1000)
write(99, id=i) a
```

c.

```
type mytype
integer a
integer b
end type mytype
write(99, id=i) mytype(4,5)
```

3. For **WRITE**, when an output item is a temporary variable:

a.

```
write(99, id=i) 99+100
```

b.

```
write(99, id=i) a+b
```

c.

```
external ff
real(8) ff
write(99, id=i) ff()
```

4. For **WRITE**, when an output item is an expression that is an array constructor:

```
write(99, id=i) (/1,2,3,4,5/)
```

5. For **WRITE**, when an output item is an expression that is a scalarized array:

```
integer a(5), b(5)
write(99, id=i) a+b
```



## System setup

Before a Fortran application that is using asynchronous I/O can run on an AIX system, you must enable asynchronous I/O. If you did not enable asynchronous I/O, a Fortran program using asynchronous I/O statements cannot be loaded. This will result in the following messages being displayed:

```
Could not load program asyncio
Symbol kaio_rdw in ksh is undefined
Symbol listio in ksh is undefined
Symbol acancel in ksh is undefined
Symbol iosuspend in ksh is undefined
Error was: Exec format error
```

For information on how to configure your system for asynchronous I/O, see "Changing Attributes for Asynchronous I/O" in *AIX 5L™ Version 5.3 Kernel Extensions and Device Support Programming Concepts*. If a Fortran program is not using Fortran asynchronous I/O statements, it will run regardless of the availability of AIX asynchronous I/O.

**Note:** You do not need to enable asynchronous I/O to use asynchronous I/O statements in a Fortran program if the AIX level is V6.1 or higher.

## Linking

If there are no asynchronous I/O statements in an application, there is no change in the way you build an application. For example, for dynamic linking, you specify:

```
xlf95 -o t t.f
```

For static linking, you specify:

```
xlf95 -o t t.f -bnso -bnodelcsect -bI:/lib/syscalls.exp -lcrypt
```

If there are asynchronous I/O statements in an application, you need additional command-line options for static linking. For example:

```
xlf95 -o t t.f -lc -bnso -bnodelcsect \
    -bI:/lib/syscalls.exp -bI:/lib/aio.exp -lcrypt
```

Note that the additional options are **-lc** and **-bI:/lib/aio.exp**.

The following table summarizes the options that you need to bind applications in different situations:

*Table 34. Table for binding an application written only in Fortran*

| Type of Linking | Fortran program using asynchronous I/O statements                                             |                                                                       |
|-----------------|-----------------------------------------------------------------------------------------------|-----------------------------------------------------------------------|
|                 | Yes                                                                                           | No                                                                    |
| Dynamic         | xlf95 -o t t.f                                                                                | xlf95 -o t t.f                                                        |
| Static          | xlf95 -o t t.f<br>-bnso -bnodelcsect<br>-bI:/lib/syscalls.exp<br>-lc -bI:/lib/aio.exp -lcrypt | xlf95 -o t t.f<br>-bnso -bnodelcsect<br>-bI:/lib/syscalls.exp -lcrypt |

Table 35. Table for binding an application written in both Fortran and C, where the C routines call the libc asynchronous I/O routines

| Type of Linking                                       | Fortran program using asynchronous I/O statements                                                 |                                                                                                   |
|-------------------------------------------------------|---------------------------------------------------------------------------------------------------|---------------------------------------------------------------------------------------------------|
|                                                       | Yes                                                                                               | No                                                                                                |
| Dynamic                                               | xlf95 -o t t.f c.o -lc                                                                            | xlf95 -o t t.f c.o -lc                                                                            |
| Static                                                | xlf95 -o t t.f c.o<br>-bnso -bnodelcsect<br>-bI:/lib/syscalls.exp<br>-lc -bI:/lib/aio.exp -lcrypt | xlf95 -o t t.f c.o<br>-bnso -bnodelcsect<br>-bI:/lib/syscalls.exp<br>-lc -bI:/lib/aio.exp -lcrypt |
| Note: c.o is an object file of routines written in C. |                                                                                                   |                                                                                                   |

You can bind an application that uses asynchronous I/O on a system with AIX asynchronous I/O disabled. However, you must run the resulting executable on an AIX V5.3 system with AIX asynchronous I/O enabled.

## Error handling

For an asynchronous data transfer, errors or end-of-file conditions might occur either during execution of the data transfer statement or during subsequent data transfer. If these conditions do not result in the termination of the program, you can detect these conditions via **ERR=**, **END=** and **IOSTAT=** specifiers in the data transfer or in the matching **WAIT** statement.

Execution of the program terminates if an error condition occurs during execution or during subsequent data transfer of an input/output statement that contains neither an **IOSTAT=** nor an **ERR=** specifier. In the case of a recoverable error, if the **IOSTAT=** and **ERR=** specifiers are not present, the program terminates if you set the **err\_recovery** runtime option to **no**. If you set the **err\_recovery** runtime option to **yes**, recovery action occurs, and the program continues.

If an asynchronous data transfer statement causes either of the following events, a matching **WAIT** statement cannot run, because the **ID=** value is not defined:

- A branch to the label that you specified by **ERR=** or **END=**
- The **IOSTAT=** specifier to be set to a non-zero value

---

## XL Fortran thread-safe I/O library

The XL Fortran runtime library **libxlf90.a** provides support for parallel execution of Fortran I/O statements.

You do not need to link with separate libraries depending on whether you are creating a threaded or a non-threaded application. XL Fortran determines at run time whether your application is threaded.

## Synchronization of I/O operations

During parallel execution, multiple threads might perform I/O operations on the same file at the same time. If they are not synchronized, the results of these I/O operations could be shuffled or merged or both, and the application might produce incorrect results or even terminate. The XL Fortran runtime library synchronizes I/O operations for parallel applications. It performs the synchronization within the I/O library, and it is transparent to application programs. The purpose of the synchronization is to ensure the integrity and correctness of each individual I/O operation. However, the run time does not have control over the order in which

threads execute I/O statements. Therefore, the order of records read in or written out is not predictable under parallel I/O operations. Refer to “Parallel I/O issues” for details.

### External files

For external files, the synchronization is performed on a per-unit basis. The XL Fortran run time ensures that only one thread can access a particular logical unit to prevent several threads from interfering with each other. When a thread is performing an I/O operation on a unit, other threads attempting to perform I/O operations on the same unit must wait until the first thread finishes its operation. Therefore, the execution of I/O statements by multiple threads on the same unit is serialized. However, the runtime environment does not prevent threads from operating on different logical units in parallel. In other words, parallel access to different logical units is not necessarily serialized.

### Functionality of I/O under synchronization

The XL Fortran runtime sets its internal locks to synchronize access to logical units. This should not have any functional impact on the I/O operations performed by a Fortran program. Also, it will not impose any additional restrictions to the operability of Fortran I/O statements except for the use of I/O statements in a signal handler that is invoked asynchronously. Refer to “Use of I/O statements in signal handlers” on page 309 for details.

## Parallel I/O issues

The order in which parallel threads perform I/O operations is not predictable. The XL Fortran run time does not have control over the ordering. It will allow whichever thread that executes an I/O statement on a particular logical unit and obtains the lock on it first to proceed with the operation. Therefore, only use parallel I/O in cases where at least one of the following is true:

- Each thread performs I/O on a predetermined record in direct-access files.
- Each thread performs I/O on a different part of a stream-access file. Different I/O statements cannot use the same, or overlapping, areas of a file.
- The result of an application does not depend on the order in which records are written out or read in.
- Each thread performs I/O on a different file.

In these cases, results of the I/O operations are independent of the order in which threads execute. However, you might not get the performance improvements that you expect, since the I/O library serializes parallel access to the same logical unit from multiple threads. Examples of these cases are as follows:

- Each thread performs I/O on a pre-determined record in a direct-access file:

```
do i = 1, 10
  write(4, '(i4)', rec = i) a(i)
enddo
```

- Each thread performs I/O on a different part of a stream-access file. Different I/O statements cannot use the same, or overlapping, areas of a file.

```
do i = 1, 9
  write(4, '(i4)', pos = 1 + 5 * (i - 1)) a(i)
  ! We use 5 above because i4 takes 4 file storage
  ! units + 1 file storage unit for the record marker.
enddo
```

- In the case that each thread operates on a different file, since threads share the status of the logical units connected to the files, the thread still needs to obtain the lock on the logical unit for either retrieving or updating the status of the logical unit. However, the runtime allows threads to perform the data transfer

between the logical unit and the I/O list item in parallel. If an application contains a large number of small I/O requests in a parallel region, you might not get the expected performance because of the lock contention. Consider the following example:

```

program example

  use omp_lib

  integer, parameter :: num_of_threads = 4, max = 5000000
  character*10 file_name
  integer i, file_unit, thread_id
  integer, dimension(max, 2 * num_of_threads) :: aa

  call omp_set_num_threads(num_of_threads)

!$omp parallel private(file_name, thread_id, file_unit, i) shared(aa)

  thread_id = omp_get_thread_num()
  file_name = 'file_'
  file_name(6:6) = char(ichar('0') + thread_id)
  file_unit = 10 + thread_id

  open(file_unit, file = file_name, status = 'old', action = 'read')

  do i = 1, max
    read(file_unit, *) aa(i, thread_id * 2 + 1), aa(i, thread_id * 2 + 2)
  end do

  close(file_unit)

!$omp end parallel
end

```

The XL Fortran runtime synchronizes retrieving and updating the status of the logical units while performing data transfer in parallel. In order to increase performance, it is recommended to increase the size of data transfer per I/O request. The do loop, therefore, should be rewritten as follows:

```

  read(file_unit, *) a(:, thread_id * 2 + 1 : thread_id * 2 + 2)

  do i = 1, max
    ! Do something for each element of array 'aa'.
  end do

```

- The result does not depend on the order in which records are written out or read in:

```

real a(100)
do i = 1, 10
  read(4) a(i)
enddo
call qsort_(a)

```

- Each thread performs I/O on a different logical unit of direct access, sequential access, or stream access:

```

do i = 11, 20
  write(i, '(i4)') a(i - 10)
enddo

```

For multiple threads to write to or read from the same sequential-access file, or to write to or read from the same stream-access file without using the **POS=** specifier, the order of records written out or read in depends on the order in which the threads execute the I/O statement on them. This order, as stated previously, is not predictable. Therefore, the result of an application could be incorrect if it assumes records are sequentially related and cannot be arbitrarily written out or read in.

For example, if the following loop is parallelized, the numbers printed out will no longer be in the sequential order from 1 to 500 as the result of a serial execution:

```
do i = 1, 500
  print *, i
enddo
```

Applications that depend on numbers being strictly in the specified order will not work correctly.

The XL Fortran runtime option **multconn=yes** allows connection of the same file to more than one logical unit simultaneously. Since such connections can only be made for reading (**ACCESS='READ'**), access from multiple threads to logical units that are connected to the same file will produce predictable results.

## Use of I/O statements in signal handlers

There are basically two kinds of signals in the POSIX signal model: *synchronously* and *asynchronously* generated signals. Signals caused by the execution of some code of a thread, such as a reference to an unmapped, protected, or bad memory (**SIGSEGV** or **SIGBUS**), floating-point exception (**SIGFPE**), execution of a trap instruction (**SIGTRAP**), or execution of illegal instructions (**SIGILL**) are said to be synchronously generated. Signals may also be generated by events outside the process: for example, **SIGINT**, **SIGHUP**, **SIGQUIT**, **SIGIO**, and so on. Such events are referred to as interrupts. Signals that are generated by interrupts are said to be asynchronously generated.

The XL Fortran run time is asynchronous signal unsafe. This means that an XL Fortran I/O statement cannot be used in a signal handler that is entered because of an asynchronously generated signal. The behavior of the system is undefined when an XL Fortran I/O statement is called from a signal handler that interrupts an I/O statement. However, it is safe to use I/O statements in signal handlers for synchronous signals.

Sometimes an application can guarantee that a signal handler is not entered asynchronously. For example, an application might mask signals except when it runs certain known sections of code. In such situations, the signal will not interrupt any I/O statements and other asynchronous signal unsafe functions. Therefore, you can still use Fortran I/O statements in an asynchronous signal handler.

A much easier and safer way to handle asynchronous signals is to block signals in all threads and to explicitly wait (using **sigwait()**) for them in one or more separate threads. The advantage of this approach is that the **handler** thread can use Fortran I/O statements as well as other asynchronous signal unsafe routines.

---

## Asynchronous thread cancellation

When a thread enables asynchronous thread cancellability, any cancellation request is acted upon immediately.

The XL Fortran runtime environment is not asynchronous thread cancellation safe. The behavior of the system is undefined if a thread is cancelled asynchronously while it is in the XL Fortran runtime environment.



---

## Chapter 11. Implementation details of XL Fortran floating-point processing

This topic answers some common questions about floating-point processing.

- How can I get predictable, consistent results?
- How can I get the fastest or the most accurate results?
- How can I detect, and possibly recover from, exception conditions?
- Which compiler options can I use for floating-point calculations?

The topics describing floating-point precision make frequent reference to the compiler options that are grouped together in *Floating-point and integer control* in the *XL Fortran Compiler Reference*, especially the **-qfloat** option. The XL Fortran compiler also provides three intrinsic modules for exception handling and IEEE arithmetic support to help you write IEEE module-compliant code that can be more portable. See *IEEE Modules and Support* in the *XL Fortran Language Reference* for details.

The use of the compiler options for floating-point calculations affects the accuracy, performance, and possibly the correctness of floating-point calculations. Although the default values for the options were chosen to provide efficient and correct execution of most programs, you may need to specify nondefault options for your applications to work the way you want. We strongly advise you to read this section before using these options.

**Note:** The discussions of single-precision, double-precision, and extended-precision calculations in this section all refer to the default situation, with **-qreal size=4** and no **-qautodb1** specified. If you change these settings, keep in mind that the size of a Fortran **REAL**, **DOUBLE PRECISION**, and so on may change, but single precision, double precision, and extended precision (in lowercase) still refer to 4-, 8-, and 16-byte entities respectively.

---

### IEEE floating-point overview

The *ANSI/IEEE Standard for Binary Floating-Point Arithmetic, ANSI/IEEE Std 754-1985 and IEEE Std 754-2008* and the details of how it applies to XL Fortran on specific hardware platforms, are summarized in the following topics.

For information on the Fortran 2003 IEEE Module and arithmetic support, see the *XL Fortran Language Reference*.

### Compiling for strict IEEE conformance

By default, XL Fortran follows most, but not all of the rules in the IEEE standard. To compile for strict compliance with the standard:

- Use the compiler option **-qfloat=nomaf**.
- If the program changes the rounding mode at run time, include **rrm** among the **-qfloat** suboptions.
- If the data or program code contains signaling NaN values (NaNs), include **nans** among the **-qfloat** suboptions. (A signaling NaN is different from a quiet NaN; you must explicitly code it into the program or data or create it by using the **-qinitauto** or **-qinitalloc** compiler option.)

- If you are compiling with **-O3**, or a higher base optimization level, include the **-qstrict** option after it. You can also use the **-qstrict** suboptions to refine the level of control for the transformations performed by the optimizers.
- If you use AIX operating system functions to enable hardware trapping on floating-point exceptions, use **-qfloat=fenv** to tell the optimizer that traps can occur.

**Related reference:**



See `-qstrict` in the Compiler Reference

## IEEE single-precision and double-precision values

XL Fortran encodes single-precision and double-precision values in IEEE format. For the range and representation, see *Real* in the *XL Fortran Language Reference*.

## IEEE extended-precision values

The IEEE standard suggests, but does not mandate, a format for extended-precision values. XL Fortran does not use this format. “Extended-precision values” on page 315 describes the format that XL Fortran uses.

## Infinities and NaNs

For single-precision real values:

- Positive infinity is represented by the bit pattern `X'7F80 0000'`.
- Negative infinity is represented by the bit pattern `X'FF80 0000'`.
- A signaling NaN is represented by any bit pattern between `X'7F80 0001'` and `X'7FBF FFFF'` or between `X'FF80 0001'` and `X'FFBF FFFF'`.
- A quiet NaN is represented by any bit pattern between `X'7FC0 0000'` and `X'7FFF FFFF'` or between `X'FFC0 0000'` and `X'FFFF FFFF'`.

For double-precision real values:

- Positive infinity is represented by the bit pattern `X'7FF00000 00000000'`.
- Negative infinity is represented by the bit pattern `X'FFF00000 00000000'`.
- A signaling NaN is represented by any bit pattern between `X'7FF00000 00000001'` and `X'7FF7FFFF FFFFFFFF'` or between `X'FFF00000 00000001'` and `X'FFF7FFFF FFFFFFFF'`.
- A quiet NaN is represented by any bit pattern between `X'7FF80000 00000000'` and `X'7FFFFFFF FFFFFFFF'` or between `X'FFF80000 00000000'` and `X'FFFFFFF FFFFFFFF'`.

These values do not correspond to any Fortran real constants. You can generate all of these by encoding the bit pattern directly, or by using the `ieee_value` function provided in the `ieee_arithmetic` intrinsic module. Using the `ieee_value` function is the preferred programming technique, as it is allowed by the Fortran 2003 standard and the results are portable. Encoding the bit pattern directly could cause portability problems on machines using different bit patterns for the different values. All except signaling NaN values can occur as the result of arithmetic operations:



```

$ cat fp_values.f
real plus_inf, minus_inf, plus_nanq, minus_nanq, nans
real large

data plus_inf /z'7f800000'/
data minus_inf /z'ff800000'/
data plus_nanq /z'7fc00000'/
data minus_nanq /z'ffc00000'/
data nans /z'7f800001'/

print *, 'Special values:', plus_inf, minus_inf, plus_nanq, minus_nanq, nans

! They can also occur as the result of operations.
large = 10.0 ** 200
print *, 'Number too big for a REAL:', large * large
print *, 'Number divided by zero:', (-large) / 0.0
print *, 'Nonsensical results:', plus_inf - plus_inf, sqrt(-large)

! To find if something is a NaN, compare it to itself.
print *, 'Does a quiet NaN equal itself:', plus_nanq .eq. plus_nanq
print *, 'Does a signaling NaN equal itself:', nans .eq. nans
! Only for a NaN is this comparison false.

end
$ xlf95 -o fp_values fp_values.f
** _main === End of Compilation 1 ===
1501-510 Compilation successful for file fp_values.f.
$ fp_values
Special values: INF -INF NaNQ -NaNQ NaNS
Number too big for a REAL: INF
Number divided by zero: -INF
Nonsensical results: NaNQ NaNQ
Does a quiet NaN equal itself: F
Does a signaling NaN equal itself: F

```

## Exception-handling model

The IEEE standard defines several exception conditions that can occur:

### OVERFLOW

The exponent of a value is too large to be represented.

### UNDERFLOW

A nonzero value is so small that it cannot be represented without an extraordinary loss of accuracy. The value can be represented only as zero or a subnormal number (denorm).

### ZERODIVIDE

A finite nonzero value is divided by zero.

### INVALID

Operations are performed on values for which the results are not defined. These include:

- Operations on signaling NaN values
- infinity - same infinity, or infinity + opposite infinity
- 0.0 \* infinity
- 0.0 / 0.0
- mod(x,y) or ieee\_rem(x,y) (or other remainder functions) when x is infinite or y is zero
- The square root of a negative number except -0.0
- Conversion of a floating-point number to an integer when the converted value cannot be represented faithfully

- Comparisons involving NaN values

### INEXACT

A computed value cannot be represented exactly, so a rounding error is introduced. (This exception is very common.)

XL Fortran always detects these exceptions when they occur, but by default does not take any special action. Calculation continues, usually with a NaN or infinity value as the result. If you want to be automatically informed when an exception occurs, you can turn on exception trapping through compiler options or calls to intrinsic subprograms. However, different results, intended to be manipulated by exception handlers, are produced:

Table 36. Results of IEEE exceptions, with and without trapping enabled

|                                  | Overflow                                 | Underflow                                | Zerodivide | Invalid   | Inexact        |
|----------------------------------|------------------------------------------|------------------------------------------|------------|-----------|----------------|
| Exceptions not enabled (default) | INF                                      | Subnormal number or zero                 | INF        | NaN       | Rounded result |
| Exceptions enabled               | Unnormalized number with biased exponent | Unnormalized number with biased exponent | No result  | No result | Rounded result |

**Note:** Because different results are possible, it is very important to make sure that any exceptions that are generated are handled correctly. See “Detecting and trapping floating-point exceptions” on page 321 for instructions on doing so.

---

## Hardware-specific floating-point overview

Single-precision and double-precision values and extended-precision values for hardware-specific floating-point processing are described in the following topics.

### Single-precision and double-precision values

The PowerPC floating-point hardware performs calculations in either IEEE single-precision (equivalent to **REAL(4)** in Fortran programs) or IEEE double-precision (equivalent to **REAL(8)** in Fortran programs).

Keep the following considerations in mind:

- Double precision provides greater range (approximately  $10^{*(-308)}$  to  $10^{*308}$ ) and precision (about 15 decimal digits) than single precision (approximate range  $10^{*(-38)}$  to  $10^{*38}$ , with about 7 decimal digits of precision).
- Computations that mix single and double operands are performed in double precision, which requires conversion of the single-precision operands to double-precision. These conversions do not affect performance.
- Double-precision values that are converted to single-precision (such as when you specify the **SNGL** intrinsic or when a double-precision computation result is stored into a single-precision variable) require rounding operations. A rounding operation produces the correct single-precision value, which is based on the IEEE rounding mode in effect. The value may be less precise than the original double-precision value, as a result of rounding error. Conversions from double-precision values to single-precision values may reduce the performance of your code.
- Programs that manipulate large amounts of floating-point data may run faster if they use **REAL(4)** rather than **REAL(8)** variables. (You need to ensure that **REAL(4)** variables provide you with acceptable range and precision.) The

programs may run faster because the smaller data size reduces memory traffic, which can be a performance bottleneck for some applications.

The floating-point hardware also provides a special set of double-precision operations that multiply two numbers and add a third number to the product. These combined multiply-add (**MAF**) operations are performed at the same speed at which either an individual multiply or add is performed. The **MAF** functions provide an extension to the IEEE 754-1985 standard (but are in the 754-2008 standard) because they perform the multiply and add with one (rather than two) rounding errors. The **MAF** functions are faster and more accurate than the equivalent separate operations.

## Extended-precision values

XL Fortran extended precision is not in the **binary128** format suggested by the IEEE standard. The IEEE standard suggests extended formats use more bits in the exponent for greater range and the fraction for greater precision.

XL Fortran extended precision, equivalent to **REAL(16)** in Fortran programs, is implemented in software. Extended precision provides the same range as double precision (about  $10^{*(-308)}$  to  $10^{*308}$ ) but more precision (a variable amount, about 31 decimal digits or more). The software support is restricted to round-to-nearest mode. Programs that use extended precision must ensure that this rounding mode is in effect when extended-precision calculations are performed. For the different ways you can control the rounding mode, see “Selecting the rounding mode” on page 316.

Programs that specify extended-precision values as hexadecimal, octal, binary, or Hollerith constants must follow these conventions:

- Extended-precision numbers are composed of two double-precision numbers with different magnitudes that do not overlap (except when the number is zero or close to zero). That is, the binary exponents differ by at least the number of fraction bits in a **REAL(8)**. The high-order double-precision value (the one that comes first in storage) must have the larger magnitude. The value of the extended-precision number is the sum of the two double-precision values.
- For a value of NaN or infinity, you must encode one of these values within the high-order double-precision value. The low-order value is not significant except that it cannot be set to NaN when the high-order value is infinity.

Because an XL Fortran extended-precision value can be the sum of two values with greatly different exponents, leaving a number of assumed zeros in the fraction, the format actually has a variable precision with a minimum of about 31 decimal digits. You get more precision in cases where the exponents of the two double values differ in magnitude by more than the number of digits in a double-precision value. This encoding allows an efficient implementation intended for applications requiring more precision but no more range than double precision.

### Note:

1. In the discussions of rounding errors because of compile-time folding of expressions, keep in mind that this folding produces different results for extended-precision values more often than for other precisions.
2. Special numbers, such as NaN, infinity, and negative zero, are not fully supported by the extended-precision values. Arithmetic operations do not necessarily propagate these numbers in extended precision.

3. XL Fortran does not always detect floating-point exception conditions (see “Detecting and trapping floating-point exceptions” on page 321) for extended-precision values. If you turn on floating-point exception trapping in programs that use extended precision, XL Fortran may also generate signals in cases where an exception condition does not really occur.
4. The exact representation is sometimes different between AIX and Linux.
5. Not all math library functions are available for extended precision.

---

## How XL Fortran rounds floating-point calculations

Understanding rounding operations in XL Fortran can help you get predictable, consistent results. It can also help you make informed decisions when you have to make tradeoffs between speed and accuracy.

In general, floating-point results from XL Fortran programs are more accurate than those from other implementations because of **MAF** operations and the higher precision used for intermediate results. If identical results are more important to you than the extra precision and performance of the XL Fortran defaults, read “Duplicating the floating-point results of other systems” on page 319.

### Selecting the rounding mode

To change the rounding mode in a program, you can call the **fpsets** and **fpgets** routines, which use an array of logicals named **fpstat**, defined in the include files `/usr/include/fpdt.h` and `/usr/include/fpdc.h`. The **fpstat** array elements correspond to the bits in the floating-point status and control register. For POWER6 and higher, they correspond to the lower half of the FPSCR bits.

For floating-point rounding control, the array elements **fpstat(fpnr1)** and **fpstat(fpnr2)** are set as specified in the following table:

*Table 37. Rounding-mode bits to use with fpsets and fpgets*

| <b>fpstat(fpnr1)</b> | <b>fpstat(fpnr2)</b> | <b>Rounding Mode Enabled</b> |
|----------------------|----------------------|------------------------------|
| .true.               | .true.               | Round towards -infinity.     |
| .true.               | .false.              | Round towards +infinity.     |
| .false.              | .true.               | Round towards zero.          |
| .false.              | .false.              | Round to nearest.            |

For example:

```

program fptest
  include 'fpdc.h'

  call fpgets( fpstat ) ! Get current register values.
  if ( (fpstat(fpnr1) .eqv. .false.) .and. +
      (fpstat(fpnr2) .eqv. .false.)) then
    print *, 'Before test: Rounding mode is towards nearest'
    print *, '          2.0 / 3.0 = ', 2.0 / 3.0
    print *, '          -2.0 / 3.0 = ', -2.0 / 3.0
  end if

  call fpgets( fpstat ) ! Get current register values.
  fpstat(fpnr1) = .TRUE. ! These 2 lines mean round towards
  fpstat(fpnr2) = .FALSE. ! +INFINITY.
  call fpsets( fpstat )
  r = 2.0 / 3.0
  print *, 'Round towards +INFINITY: 2.0 / 3.0= ', r

```

```

        call fpgets( fpstat ) ! Get current register values.
        fpstat(fprn1) = .TRUE. ! These 2 lines mean round towards
        fpstat(fprn2) = .TRUE. ! -INFINITY.
        call fpsets( fpstat )
        r = -2.0 / 3.0
        print *, 'Round towards -INFINITY: -2.0 / 3.0= ', r
    end
! This block data program unit initializes the fpstat array, and so on.
    block data
        include 'fpdc.h'
        include 'fpdt.h'
    end

```

XL Fortran also provides several procedures that allow you to control the floating-point status and control register of the processor directly. These procedures are more efficient than the **fpsets** and **fpgets** subroutines because they are mapped into inlined machine instructions that manipulate the floating-point status and control register (fpscr) directly.

XL Fortran supplies the **get\_round\_mode()** and **set\_round\_mode()** procedures in the `xl_f_fp_util` module. These procedures return and set the current binary floating-point rounding mode, respectively.

For example:

```

program fptest
    use, intrinsic :: xlf_fp_util
    integer(fpscr_kind) old_fpscr
    if ( get_round_mode() == fp_rnd_rn ) then
        print *, 'Before test: Rounding mode is towards nearest'
        print *, '          2.0 / 3.0 = ', 2.0 / 3.0
        print *, '          -2.0 / 3.0 = ', -2.0 / 3.0
    end if

    old_fpscr = set_round_mode( fp_rnd_rp )
    r = 2.0 / 3.0
    print *, 'Round towards +infinity: 2.0 / 3.0 = ', r

    old_fpscr = set_round_mode( fp_rnd_rm )
    r = -2.0 / 3.0
    print *, 'Round towards -infinity: -2.0 / 3.0 = ', r
end

```

XL Fortran supplies the **ieee\_get\_rounding\_mode()** and **ieee\_set\_rounding\_mode()** procedures in the `ieee_arithmetic` module. These portable procedures retrieve and set the current floating-point rounding mode, respectively.

For example:

```

program fptest
    use, intrinsic :: ieee_arithmetic
    type(ieee_round_type) current_mode
    call ieee_get_rounding_mode( current_mode )
    if ( current_mode == ieee_nearest ) then
        print *, 'Before test: Rounding mode is towards nearest'
        print *, '          2.0 / 3.0 = ', 2.0 / 3.0
        print *, '          -2.0 / 3.0 = ', -2.0 / 3.0
    end if

    call ieee_set_rounding_mode( ieee_up )
    r = 2.0 / 3.0
    print *, 'Round towards +infinity: 2.0 / 3.0 = ', r
end

```

```

call ieee_set_rounding_mode( ieee_down )
r = -2.0 / 3.0
print *, 'Round towards -infinity: -2.0 / 3.0 = ', r
end

```

#### Notes:

1. Extended-precision floating-point values must only be used in round-to-nearest mode.
2. For thread-safety and reentrancy, the include file `/usr/include/fpdc.h` contains a **THREADLOCAL** directive that is protected by the trigger constant **IBMT**. The invocation commands `xlf_r`, `xlf_r7`, `xlf90_r`, `xlf90_r7`, `xlf95_r`, `xlf95_r7`, `xlf2003_r`, and `xlf2008_r` turn on the **-qthreaded** compiler option by default, which in turn implies the trigger constant **IBMT**. If you are including the file `/usr/include/fpdc.h` in code that is not intended to be threadsafe, do not specify **IBMT** as a trigger constant.
3. Compile a program that changes the rounding mode with **-qfloat=rrm**.

For more information about the bits in the FPSCR register that correspond to the **fpstat** array elements, see the *POWERstation and POWERserver Hardware Technical Reference - General Information*.

## Minimizing rounding errors

There are several strategies for handling rounding errors and other unexpected, slight differences in calculated results. You may want to consider one or more of the following strategies:

- Minimizing the amount of overall rounding
- Delaying as much rounding as possible to run time
- Ensuring that if some rounding is performed in a mode other than round-to-nearest, *all* rounding is performed in the same mode

## Minimizing overall rounding

Rounding operations, especially in loops, reduce code performance and may have a negative effect on the precision of computations. Consider using double-precision variables instead of single-precision variables when you store the temporary results of single-precision calculations, and delay rounding operations until the final result is computed. You can also specify the **hssngl** suboption of **-qfloat** instead of converting a stored single-precision result back to double-precision. This suboption preserves computed double-precision results so that they can be used again later.

## Delaying rounding until run time

The compiler evaluates floating-point expressions during compilation when it can, so that the resulting program does not run more slowly due to unnecessary runtime calculations. However, the results of the compiler's evaluation might not match exactly the results of the runtime calculation. To delay these calculations until run time, specify the **nofold** suboption of the **-qfloat** option.

The results may still not be identical; for example, calculations in **DATA** and **PARAMETER** statements are still performed at compile time.

The differences in results due to **fold** or **nofold** are greatest for programs that perform extended-precision calculations or are compiled with the **-0** option or both.

## Ensuring that the rounding mode is consistent

You can change the rounding mode from its default setting of round-to-nearest. (See for examples.) If you do so, you must be careful that *all* rounding operations for the program use the same mode:

- Specify the equivalent setting on the **-qieee** option, so that any compile-time calculations use the same rounding mode.
- Specify the **rrm** suboption of the **-qfloat** option, so that the compiler does not perform any optimizations that require round-to-nearest rounding mode to work correctly.

For example, you might compile a program like the one in “Selecting the rounding mode” on page 316 with this command if the program consistently uses round-to-plus-infinity mode:

```
xlf95 -qieee=plus -qfloat=rrm changes_rounding_mode.f
```

---

## Duplicating the floating-point results of other systems

To duplicate the double-precision results of programs on systems with different floating-point architectures (without multiply-add instructions), specify the **nomaf** suboption of the **-qfloat** option. This suboption prevents the compiler from generating any multiply-add or multiply-subtract instructions except the following cases:

- Instructions used in the **COMPLEX** operations
- Instructions required for multiply-add or multiply-subtract built in functions or the **fma** function

This results in decreased accuracy and performance but provides strict conformance to the IEEE standard for double-precision arithmetic.

To duplicate the results of programs where the default size of **REAL** items is different from that on systems running XL Fortran, use the **-qrealsize** option to change the default **REAL** size when compiling with XL Fortran.

If the system whose results you want to duplicate preserves full double precision for default real constants that are assigned to **DOUBLE PRECISION** variables, use the **-qdpc** or **-qrealsize** option.

If results consistent with other systems are important to you, include **norsqrt** and **nofold** in the settings for the **-qfloat** option.

If you specify the option **-03**, **-04**, or **-05**, include **-qstrict** and any necessary suboptions too.

### Related information:



See **-qarch** in the Compiler Reference



See **-qfloat** in the Compiler Reference



See **-qrealsize** in the Compiler Reference



See **-qstrict** in the Compiler Reference

---

## Maximizing floating-point performance

If performance is your primary concern and you want your program to be relatively safe but do not mind if results are slightly different (generally more precise) from what they would be otherwise, optimize the program with the **-O** option, and specify **-qfloat=rsqrt:hssngl:fltint**.

The following topics describe the functions of these suboptions:

- The **rsqrt** suboption replaces division by a square root with multiplication by the reciprocal of the root, a faster operation that may not produce precisely the same result.
- The **hssngl** suboption is the opposite of **rndsngl**; it improves the performance of single-precision (**REAL(4)**) floating-point calculations by suppressing rounding operations that are required by the Fortran language but are not necessary for correct program execution. The results of floating-point expressions are kept in double precision where the original program would round them to single-precision. These results are then used in some later expressions instead of the rounded results.

To detect single-precision floating-point overflows and underflows, rounding operations are still inserted when double-precision results are stored into single-precision memory locations. However, if optimization removes such a store operation, **hssngl** also removes the corresponding rounding operation, possibly preventing the exception. (Depending on the characteristics of your program, you may or may not care whether the exception happens.)

The **hssngl** suboption is safe for all types of programs because it always only *increases* the precision of floating-point calculations. Program results may differ because of the increased precision and because of avoidance of some exceptions.

- The **fltint** suboption speeds up float-to-integer conversions by reducing error checking for overflows when the program is compiled to run on older processors. You should make sure that any floats that are converted to integers are not outside the range of the corresponding integer types.

In cases where speed is so important that you can make an informed decision to sacrifice correctness at boundary conditions, you can replace **hssngl** and **fltint** with the **hsflt** suboption; it does the same thing as **fltint** and suppresses rounding operations.

In suppressing rounding operations, **hsflt** works like **hssngl**, but it also suppresses rounding operations when double-precision values or single-precision values calculated in double-precision are assigned to single-precision memory locations. Single-precision overflow is not detected in such assignments, and the assigned value is not correctly rounded according to the current rounding mode.

**Attention:** When you use the **hsflt** suboption, observe these restrictions, or your program may produce incorrect results without warning:

- Your program must never attempt to convert floating-point values to integer when the floating-point values are outside the range of the corresponding integer types.
- Your program must never compute NaNs, or values outside the range of single precision.
- Your program must not depend on results to be correctly rounded to single precision: for example, by comparing two single-precision values for equality.



Therefore, we recommend that you use this suboption only with extreme caution. It is for use by knowledgeable programmers in specific applications, such as graphics programs, where the computational characteristics are known. If you are at all unsure whether a program is suitable or if the program produces unexpected results when you use this suboption, use **hssngl** instead.

*Technical details of the `-qfloat=hsflt` option in the XL Fortran Compiler Reference provides additional technical information about this suboption.*

---

## Detecting and trapping floating-point exceptions

The IEEE standard for floating-point arithmetic defines a number of exception (or error) conditions that might require special care to avoid or recover from. The following topics are intended to help you make your programs work safely in the presence of such exception conditions while sacrificing the minimum amount of performance.

The floating-point hardware always detects a number of floating-point exception conditions (which the IEEE standard rigorously defines): overflow, underflow, zerodivide, invalid, and inexact.

By default, the only action that occurs is that a status flag is set. The program continues without a problem (although the results from that point on may not be what you expect). If you want to know when an exception occurs, you can arrange for one or more of these exception conditions to generate a signal.

The signal causes a branch to a handler routine. The handler receives information about the type of signal and the state of the program when the signal occurred. It can produce a core dump, display a listing showing where the exception occurred, modify the results of the calculation, or carry out some other processing that you specify.

The XL Fortran compiler and the operating system provide facilities for working with floating-point exception conditions. The compiler facilities indicate the presence of exceptions by generating **SIGTRAP** signals. The operating-system facilities generate **SIGFPE** signals. Do not mix these different facilities within a single program.

## Compiler features for trapping floating-point exceptions

To turn on XL Fortran exception trapping, compile the program with the **-qfltrap** option and some combination of suboptions that includes **enable**. This option uses trap operations to detect floating-point exceptions and generates **SIGTRAP** signals when exceptions occur, provided that a signal handler for **SIGTRAP** is installed.

**-qfltrap** also has suboptions that correspond to the names of the exception conditions. For example, if you are only concerned with handling overflow and underflow exceptions, you can specify a command similar to the following one:

```
xlf95 -qfltrap=overflow:underflow:enable compute_pi.f
```

You only need **enable** when you are compiling the main program. However, it is very important then and does not cause any problems if you specify it for other files, so always include it when you use **-qfltrap**.

To reduce performance impact, you can include the **imprecise** suboption of the **-qflttrap** option. This suboption delays any trapping until the program reaches the start or end of a subprogram.

The disadvantages of this approach include:

- It only traps exceptions that occur in code that you compiled with **-qflttrap**, which does not include system library routines.
- It is generally not possible for a handler to substitute results for failed calculations if you use the **imprecise** suboption of **-qflttrap**.

**Notes:**

1. If your program depends on floating-point exceptions occurring for particular operations, also specify **-qfloat** suboptions that include **nofold** and **nohssngl**. Otherwise, the compiler might replace an exception-producing calculation with a constant NaN or infinity value, or it might eliminate an overflow in a single-precision operation.
2. The suboptions of the **-qflttrap** option replace an earlier technique that required you to modify your code with calls to the **fpsets** and **fpgets** procedures. You no longer require these calls for exception handling if you use the appropriate **-qflttrap** settings.

**Attention:** If your code contains **fpsets** calls that enable checking for floating-point exceptions and you do not use the **-qflttrap** option when compiling the whole program, the program will produce unexpected results if exceptions occur, as explained in Table 36 on page 314.

## Operating system features for trapping floating-point exceptions

A direct way to turn on exception trapping is to call the operating system routine **fp\_trap**. It uses the system hardware to detect floating-point exceptions and generates **SIGFPE** signals when exceptions occur. Fortran definitions for the values needed to call it are in the files `/usr/include/fp_fort_c.f`, `/usr/include/fp_fort_t.f`, or the `xlf_fp_util` module.

There are other related operating system routines that you can locate by reading the description of **fp\_trap**.

The advantages of this approach include:

- It works for any code, regardless of the language and without the need to compile with any special options.
- It generates **SIGFPE** signals, the same as other popular UNIX systems.
- On most newer processor models, it has no execution cost unless an exception occurs.

The disadvantages of this approach include:

- On older processor models, the program might run much slower when exception checking is turned on.
- The call to **FP\_TRAP** is nonportable and requires a source-code change and thus a recompilation. Also, it might require another source change and recompilation each time it is turned on or off.
- For correct operation, you must compile the program with **-qfloat=fenv**.

## Installing an exception handler

The information in this section, except the explanation of the **-qsigtrap** option, applies both to **SIGTRAP** and **SIGFPE** signals. When a program that uses the XL Fortran or AIX exception-detection facilities encounters an exception condition, it receives a signal from the operating system. This causes a branch to whatever handler is specified by the program.

By default, the program stops after producing a core file, which you can use with a debugger to locate the problem. If you want to install a **SIGTRAP** signal handler, use the **-qsigtrap** option. It allows you to specify an XL Fortran handler that produces a traceback or to specify a handler you have written:

```
xlf95 -qfltrap=ov:und:en pi.f # Dump core on an exception
xlf95 -qfltrap=ov:und:en -qsigtrap pi.f # Uses the xl_trce handler
xlf95 -qfltrap=ov:und:en -qsigtrap=return_22_over_7 pi.f # Uses any other handler
```

You can also install an alternative exception handler, either one supplied by XL Fortran or one you have written yourself, by calling the **SIGNAL** subroutine (defined in `/usr/include/fexcp.h`):

```
INCLUDE 'fexcp.h'
CALL SIGNAL(SIGTRAP,handler_name)
CALL SIGNAL(SIGFPE,handler_name)
```

The XL Fortran exception handlers and related routines are:

### **xl\_ieee**

Produces a traceback and an explanation of the signal and continues execution by supplying the default IEEE result for the failed computation. This handler allows the program to produce the same results as if exception detection was not turned on.

### **xl\_trce**

Produces a traceback and stops the program.

### **xl\_trcedump**

Produces a traceback and a core file and stops the program.

### **xl\_sigdump**

Provides a traceback that starts from the point at which it is called and provides information about the signal. You can only call it from inside a user-written signal handler, and it requires the same parameters as other AIX signal handlers. It does not stop the program. To successfully continue, the signal handler must perform some cleanup after calling this subprogram.

### **xl\_trbk**

Provides a traceback that starts from the point at which it is called. You call it as a subroutine from your code, rather than specifying it with the **-qsigtrap** option. It requires no parameters. It does not stop the program.

All of these handler names contain double underscores to avoid duplicating names that you declared in your program. All of these routines work for both **SIGTRAP** and **SIGFPE** signals.

You can use the **-g** compiler option to get line numbers in the traceback listings. The file `/usr/include/fsignal.h` defines a Fortran derived type similar to the `ucontext_t` structure in `/usr/include/sys/ucontext.h`. You can write a Fortran signal handler that accesses this derived type.

“Sample programs for exception handling” on page 326 lists some sample programs that illustrate how to use these signal handlers or write your own. Also see the **SIGNAL** procedure in the *XL Fortran Language Reference* for more information.

## Producing a core file

To produce a core file, do not install an exception handler, or else specify the `xl_trcdump` handler.

## Controlling the floating-point status and control register

Before the introduction of `-qflttrap` suboptions or the `-qsigtrap` options, most of the processing for floating-point exceptions required you to change your source files to turn on exception trapping or install a signal handler. Although you can still do so, for any new applications, we recommend that you use the options instead.

To control exception handling at run time, compile without the `enable` suboption of the `-qflttrap` option:

```
xlF95 -qflttrap compute_pi.f    # Check all exceptions, but do not trap.
xlF95 -qflttrap=ov compute_pi.f # Check one type, but do not trap.
```

Then, inside your program, manipulate the `fpstats` array (defined in the include file `/usr/include/fpdc.h`) and call the `fpsets` subroutine to specify which exceptions should generate traps.

See the sample program that uses `fpsets` and `fpgets` in “Selecting the rounding mode” on page 316.

Another method is to use the `set_fpscr_flags()` subroutine in the `xlF_fp_util` module. This subroutine allows you to set the floating-point status and control register flags you specify in the `MASK` argument. Flags that you do not specify in `MASK` remain unaffected. `MASK` must be of type `INTEGER(FPSCR_KIND)`. For example:

```
USE, INTRINSIC :: xlf_fp_util
INTEGER(FPSCR_KIND) SAVED_FPSCR
INTEGER(FP_MODE_KIND) FP_MODE

SAVED_FPSCR = get_fpscr()           ! Saves the current value of
                                   ! the fpscr register.

CALL set_fpscr_flags(TRP_DIV_BY_ZERO) ! Enables trapping of
! ...                               ! divide-by-zero.
SAVED_FPSCR=set_fpscr(SAVED_FPSCR)   ! Restores fpscr register.
```

Another method is to use the `ieee_set_halting_mode` subroutine in the `ieee_exceptions` module. This portable subroutine allows you to set the halting (trapping) status for any `FPSCR` exception flags. For example:

```
USE, INTRINSIC :: ieee_exceptions
TYPE(IEEE_STATUS_TYPE) SAVED_FPSCR
CALL ieee_get_status(SAVED_FPSCR) ! Saves the current value of the
                                   ! fpscr register

CALL ieee_set_halting_mode(IEEE_DIVIDE_BY_ZERO, .TRUE.) ! Enabled trapping
! ...  ! of divide-by-zero.

CALL IEEE_SET_STATUS(SAVED_FPSCR) ! Restore fpscr register
```

## xlf\_fp\_util procedures

The `xlf_fp_util` procedures allow you to query and control the floating-point status and control register (fpscr) of the processor directly. These procedures are more efficient than the `fpsets` and `fpgets` subroutines because they are mapped into inlined machine instructions that manipulate the floating-point status and control register directly.

The intrinsic module, `xlf_fp_util`, contains the interfaces and data type definitions for these procedures and the definitions for the named constants that are needed by the procedures. This module enables type checking of these procedures at compile time rather than link time. The following files are supplied for the `xlf_fp_util` module:

| File names      | File type                   | Locations                                                 |
|-----------------|-----------------------------|-----------------------------------------------------------|
| xlf_fp_util.mod | module symbol file (32-bit) | /opt/IBM/xlf/15.1.0/include_d7/opt/IBM/xlf/15.1.0/include |
|                 | module symbol file (64-bit) | /opt/IBM/xlf/15.1.0/include                               |

To use the procedures, you must add a `USE XLF_FP_UTIL` statement to your source file. For more information, see the `USE` statement in the *XL Fortran Language Reference*.

When compiling with the `-U` option, you must code the names of these procedures in all lowercase.

For a list of the `xlf_fp_util` procedures, see the *Service and utility procedures* section in the *XL Fortran Language Reference*.

## fpgets and fpsets subroutines

The `fpsets` and `fpgets` subroutines provide a way to manipulate or query the floating-point status and control register. Instead of calling the operating system routines directly, you pass information back and forth in `fpstat`, an array of logicals. The following table shows the most commonly used array elements that deal with exceptions:

Table 38. Exception bits to use with `fpsets` and `fpgets`

| Array Element to Set to Enable | Array Element to Check if Exception Occurred | Exception Indicated When .TRUE.                    |
|--------------------------------|----------------------------------------------|----------------------------------------------------|
| n/a                            | fpstat(fpfx)                                 | Floating-point exception summary                   |
| n/a                            | fpstat(fpfex)                                | Floating-point enabled exception summary           |
| fpstat(fpve)                   | fpstat(fpvx)                                 | Floating-point invalid operation exception summary |
| fpstat(fpoe)                   | fpstat(fpox)                                 | Floating-point overflow exception                  |
| fpstat(fpue)                   | fpstat(fpux)                                 | Floating-point underflow exception                 |
| fpstat(fpze)                   | fpstat(fpzx)                                 | Zero-divide exception                              |
| fpstat(fpxe)                   | fpstat(fpxx)                                 | Inexact exception                                  |
| fpstat(fpve)                   | fpstat(fpvxsnan)                             | Floating-point invalid operation exception (NaNs)  |

Table 38. Exception bits to use with `fpsets` and `fpgets` (continued)

| Array Element to Set to Enable | Array Element to Check if Exception Occurred | Exception Indicated When <code>.TRUE.</code>                                       |
|--------------------------------|----------------------------------------------|------------------------------------------------------------------------------------|
| <code>fpstat(fpve)</code>      | <code>fpstat(fpvxisi)</code>                 | Floating-point invalid operation exception (INF-INF)                               |
| <code>fpstat(fpve)</code>      | <code>fpstat(fpvxidi)</code>                 | Floating-point invalid operation exception (INF/INF)                               |
| <code>fpstat(fpve)</code>      | <code>fpstat(fpvxzdz)</code>                 | Floating-point invalid operation exception (0/0)                                   |
| <code>fpstat(fpve)</code>      | <code>fpstat(fpvximz)</code>                 | Floating-point invalid operation exception (INF*0)                                 |
| <code>fpstat(fpve)</code>      | <code>fpstat(fpvxvc)</code>                  | Floating-point invalid operation exception (invalid compare)                       |
| n/a                            | <code>fpstat(fpvxsoft)</code>                | Floating-point invalid operation exception (software request), PowerPC only        |
| n/a                            | <code>fpstat(fpvxsqrt)</code>                | Floating-point invalid operation exception (invalid square root), PowerPC only     |
| n/a                            | <code>fpstat(fpvx cvi)</code>                | Floating-point invalid operation exception (invalid integer convert), PowerPC only |

To explicitly check for specific exceptions at particular points in a program, use `fpgets` and then test whether the elements in `fpstat` have changed. Once an exception has occurred, the corresponding exception bit (second column in the preceding table) is set until it is explicitly reset, except for `fpstat(fpfx)`, `fpstat(fpvx)`, and `fpstat(fpfex)`, which are reset only when the specific exception bits are reset.

An advantage of using the `fpgets` and `fpsets` subroutines (as opposed to controlling everything with suboptions of the `-qflttrap` option) includes control over granularity of exception checking. For example, you might only want to test if an exception occurred anywhere in the program when the program ends.

The disadvantages of this approach include the following:

- You have to change your source code.
- These routines differ from what you may be accustomed to on other platforms.

For example, to trap floating-point overflow exceptions but only in a certain section of the program, you would set `fpstat(fpoe)` to `.TRUE.` and call `fpsets`. After the exception occurs, the corresponding exception bit, `fpstat(fpox)`, is `.TRUE.` until the program runs:

```
call fpgets(fpstat)
fpstat(fpox) = .FALSE.
call fpsets(fpstat) ! resetting fpstat(fpox) to .FALSE.
```

## Sample programs for exception handling

Sample programs contained in `/opt/IBM/xlf/15.1.3/samples/floating_point` illustrate different aspects of exception handling:

### `flttrap_handler.c` and `flttrap_test.f`

A sample exception handler that is written in C and a Fortran program that uses it.

### **xl\_ieee.F and xl\_ieee.c**

Exception handlers that are written in Fortran and C that show how to substitute particular values for operations that produce exceptions. Even when you use support code such as this, the implementation of XL Fortran exception handling does not fully support the exception-handling environment that is suggested by the IEEE floating-point standard.

### **check\_fpshr.f and postmortem.f**

Show how to work with the **fpsets** and **fpgets** procedures and the **fpstats** array.

### **fhandler.F**

Shows a sample Fortran signal handler and demonstrates the **xl\_sigdump** procedure.

### **xl\_trbk\_test.f**

Shows how to use the **xl\_trbk** procedure to generate a traceback listing without stopping the program.

The sample programs are strictly for illustrative purposes only.

## **Causing exceptions for particular variables**

To mark a **REAL** variable as “do not use”, you can encode a special value called a signaling NaN in it. This causes an invalid exception condition any time that variable is used in a calculation.

If you use this technique, use the **nans** suboption of the **-qfloat** option and the **-qstrict** or **-qstrict=nans** option, so that the program properly detects all cases where a signaling NaN is used, and one of the methods already described to generate corresponding **SIGFPE** or **SIGTRAP** signals.

### **Notes:**

1. Because a signaling NaN is never generated as the result of a calculation and must be explicitly introduced to your program as a constant or in input data, you should not need to use this technique unless you deliberately use signaling NaN values in it.
2. In previous XL Fortran releases, the **-qfloat** suboption was called **spnans**. In the future, use **nans** instead (although **spnans** still works, for compatibility).

## **Minimizing the performance impact of floating-point exception trapping**

If you need to deal with floating-point exception conditions but are concerned that doing so will make your program too slow, here are some techniques that can help minimize the performance impact:

- Consider using only a subset of the **overflow**, **underflow**, **zerodivide**, **invalid**, and **inexact** suboptions with the **-qflttrap** option if you can identify some conditions that will never happen or you do not care about. In particular, because an **inexact** exception occurs for each rounding error, you probably should not check for it if performance is important.
- Include the **imprecise** suboption with the **-qflttrap** option, so that your compiler command looks similar to this:

```
xl f90 -qflttrap=underflow:enable:imprecise does_underflows.f
```

**imprecise** makes the program check for the specified exceptions only on entry and exit to subprograms that perform floating-point calculations. This means

that XL Fortran will eventually detect any exception, but you will know only the general area where it occurred, not the exact location.

When you specify **-qfltrap** without **imprecise**, a check for exceptions follows each floating-point operation. If all your exceptions occur during calls to routines that are not compiled with **-qfltrap** (such as library routines), using **imprecise** is generally a good idea, because identifying the exact location will be difficult anyway.

Note that **enable** has no effect if using the **nanq** suboption. **nanq** generates trapping code after each floating-point arithmetic, load instruction and procedure returning floating-point values even if **imprecise** is specified.

It is more difficult to use the **fp\_trap** function; however, on recent processors, using the **fp\_trap** function is faster than using **-qfltrap**.



---

## Chapter 12. Porting programs to XL Fortran

XL Fortran provides many features intended to make it easier to take programs that were originally written for other computer systems or compilers and recompile them with XL Fortran.

---

### Outline of the porting process

To port a typical program, you need to identify the nonportable features, modify the source files to remove or work around these features, and compile the program with XL Fortran so you can compare the output with the output from the other system.

The process for porting a typical program looks like this:

1. Identify any nonportable language extensions or features that you used in the original program. Check to see if any of them are supported by XL Fortran:
  - Language extensions are identified in the *XL Fortran Language Reference*.
  - Some extensions require you to specify an XL Fortran compiler option; you can find these options listed in the *Portability and migration options* table in the *XL Fortran Compiler Reference*.
2. For any nonportable features that XL Fortran does not support, modify the source files to remove or work around them.
3. Do the same for any implementation-dependent features. For example, if your program relies on exact bit-pattern representation of floating-point values or uses system-specific file names, you may need to change it.
4. Compile the program with XL Fortran. If any compilation problems occur, fix them and recompile and fix any additional errors until the program compiles successfully.
5. Run the XL Fortran-compiled program and compare the output with the output from the other system. If the results are substantially different, there are probably still some implementation-specific features that need to be changed. If the results are only marginally different (for example, if XL Fortran produces a different number of digits of precision or a number differs in the last decimal place), decide whether the difference is significant enough to investigate further. You might be able to fix these differences.

Before porting programs to XL Fortran, read the tips in the following sections so that you know in advance what compatibility features XL Fortran offers.

---

### Maintaining FORTRAN 77 source and object code

You can use the compiler of this release to recompile existing FORTRAN 77 programs from XL Fortran Version 2 or later releases.

You can link existing FORTRAN 77 object code from previous version of XL Fortran into programs generated by the compiler of this release. See *Linking new objects with existing ones* in the *XL Fortran Compiler Reference* for details.

---

## Portability of directives

XL Fortran supports many directives available with other Fortran products. This ensures easy portability between products.

If your code contains *trigger\_constants* other than the defaults in XL Fortran, you can use the **-qdirective** compiler option to specify them. For instance, if you are porting CRAY code contained in a file *xx.f*, you would use the following command to add the CRAY *trigger\_constant*:

```
xlf95 xx.f -qdirective=mic\%
```

For fixed source form code, in addition to the **!** value for the *trigger\_head* portion of the directive, XL Fortran also supports the *trigger\_head* values **C**, **c**, and **\***.

For more information, see the **-qdirective** option in the *XL Fortran Compiler Reference*.

XL Fortran supports a number of programming terms as synonyms to ease the effort of porting code from other Fortran products. Those terms that are supported are dependent on context, as indicated in the following tables:

Table 39. PARALLEL DO Clauses and their XL Fortran synonyms

| PARALLEL DO Clause           | XL Fortran Synonym |
|------------------------------|--------------------|
| LASTLOCAL                    | LASTPRIVATE        |
| LOCAL                        | PRIVATE            |
| MP_SCHEDULETYPE<br>and CHUNK | SCHEDULE           |
| SAVELAST                     | LASTPRIVATE        |
| SHARE                        | SHARED             |
| NEW                          | PRIVATE            |

Table 40. PARALLEL DO scheduling types and their XL Fortran synonyms

| Scheduling Type | XL Fortran Synonym |
|-----------------|--------------------|
| GSS             | GUIDED             |
| INTERLEAVE      | STATIC(1)          |
| INTERLEAVED     | STATIC(1)          |
| INTERLEAVE(n)   | STATIC(n)          |
| INTERLEAVED(n)  | STATIC(n)          |
| SIMPLE          | STATIC             |

Table 41. PARALLEL SECTIONS clauses and their XL Fortran synonyms

| PARALLEL SECTIONS Clause | XL Fortran Synonym |
|--------------------------|--------------------|
| LOCAL                    | PRIVATE            |
| SHARE                    | SHARED             |
| NEW                      | PRIVATE            |

---

## Common industry extensions that XL Fortran supports

XL Fortran allows many of the same FORTRAN 77 extensions as other popular compilers.

These extensions include:

| <b>Extension</b>                                                                                                                                                                                                                                                                                                                          | <b>Refer to <i>XL Fortran Language Reference</i> Section(s)</b> |
|-------------------------------------------------------------------------------------------------------------------------------------------------------------------------------------------------------------------------------------------------------------------------------------------------------------------------------------------|-----------------------------------------------------------------|
| Typeless constants                                                                                                                                                                                                                                                                                                                        | Typeless literal constants                                      |
| <i>*len</i> length specifiers for types                                                                                                                                                                                                                                                                                                   | Data types                                                      |
| <b>BYTE</b> data type                                                                                                                                                                                                                                                                                                                     | Byte                                                            |
| Long variable names                                                                                                                                                                                                                                                                                                                       | Names                                                           |
| Lower case                                                                                                                                                                                                                                                                                                                                | Names                                                           |
| Mixing integers and logicals (with <b>-qintlog</b> option)                                                                                                                                                                                                                                                                                | Evaluation of expressions                                       |
| Character-count <b>Q</b> edit descriptor (with <b>-qqcount</b> option)                                                                                                                                                                                                                                                                    | Q (Character Count) Editing                                     |
| Intrinsics for counting set bits in registers and determining data-object parity                                                                                                                                                                                                                                                          | POPCNT, POPPAR                                                  |
| 64-bit data types ( <b>INTEGER(8)</b> , <b>REAL(8)</b> , <b>COMPLEX(8)</b> , and <b>LOGICAL(8)</b> ), including support for default 64-bit types (with <b>-qintsize</b> and <b>-qrealsize</b> options)                                                                                                                                    | Integer Real Complex Logical                                    |
| Integer <b>POINTERS</b> , similar to those supported by CRAY and Sun compilers. (XL Fortran integer pointer arithmetic uses increments of one byte, while the increment on CRAY computers is eight bytes. You may need to multiply pointer increments and decrements by eight to make programs ported from CRAY computers work properly.) | POINTER(integer)                                                |
| Conditional vector merge (CVMGx) intrinsic functions                                                                                                                                                                                                                                                                                      | CVMGx (TSOURCE, FSOURCE, MASK)                                  |
| Date and time service and utility functions (rtc, irtc, jdate, clock_, timef, and date)                                                                                                                                                                                                                                                   | Service and utility procedures                                  |
| <b>STRUCTURE</b> , <b>UNION</b> , and <b>MAP</b> constructs                                                                                                                                                                                                                                                                               | Structure components, Union and map                             |

### Finding nonstandard extensions

XL Fortran supports a number of extensions to various language standards. Many of these extensions are so common that you need to keep in mind, when you port programs to other systems, that not all compilers have them. To find such extensions in your XL Fortran programs before beginning a porting effort, use the **-qlanglvl** option:

```
$ # -qnoobject stops the compiler after parsing all the source,  
$ # giving a fast way to check for errors.  
$ # Look for anything above the base F77 standard.  
$ xlf -qnoobject -qlanglvl=77std f77prog.f  
...  
$ # Look for anything above the F90 standard.  
$ xlf90 -qnoobject -qlanglvl=90std use_in_2000.f
```

```
...
$ # Look for anything above the F95 standard.
$ xlf95 -qnoobject -qlanglvl=95std use_in_2000.f
...
```

**Related reference:**



See `-langlvl` in the Compiler Reference



See `-qport` in the Compiler Reference

## Mixing data types in statements

The `-qctyp1ss` option lets you use character constant expressions in the same places that you use typeless constants. The `-qintlog` option lets you use integer expressions where you can use logicals, and vice versa. A kind type parameter must not be replaced with a logical constant even if `-qintlog` is on, nor by a character constant even if `-qctyp1ss` is on, nor can it be a typeless constant.

## Date and time routines

Date and time routines, such as `dtime`, `etime`, and `jdate`, are accessible as Fortran subroutines.

## Other libc routines

A number of other popular routines from the `libc` library, such as `flush`, `getenv`, and `system`, are also accessible as Fortran subroutines.

## Changing the default sizes of data types

For porting from machines with larger or smaller word sizes, the `-qintsize` option lets you specify the default size for integers and logicals. The `-qrealsize` option lets you specify the default size for reals and complex components.

## Name conflicts between your procedures and XL Fortran intrinsic procedures

If you have procedures with the same names as any XL Fortran intrinsic procedures, the program calls the intrinsic procedure. This situation is more likely with the addition of the many new Fortran 90, Fortran 95, Fortran 2003, and Fortran 2008 intrinsic procedures.

If you still want to call your procedure, add explicit interfaces, `EXTERNAL` statements, or `PROCEDURE` statements for any procedures with conflicting names, or use the `-qextern` option when compiling.

## Reproducing results from other systems

XL Fortran provides settings through the `-qfloat` option that help make floating-point results consistent with those from other IEEE systems; this subject is discussed in “Duplicating the floating-point results of other systems” on page 319.

---

## Chapter 13. Sample Fortran programs

The programs in the topics referenced here are provided as coding examples for XL Fortran.

Other examples can be found in the `/opt/IBM/xlf/15.1.0/samples` directory. These illustrate various aspects of XL Fortran programming. A number of these samples illustrate various aspects of SMP programming that may be new to many users. If you are new to SMP programming, you should examine these samples to gain a better understanding of the SMP coding style.

You can compile and execute the first program to verify that the compiler is installed correctly and your user ID is set up to execute Fortran programs.

---

### Example 1 - XL Fortran source file

This is an example of an XL Fortran source file

```
PROGRAM CALCULATE
!
! Program to calculate the sum of up to n values of x**3
! where negative values are ignored.
!
  IMPLICIT NONE
  INTEGER I,N
  REAL SUM,X,Y
  READ(*,*) N
  WRITE(*,*) N
  SUM=0
  DO I=1,N
    READ(*,*) X
    WRITE(*,*) X
    IF (X.GE.0.0) THEN
      Y=X**3
      SUM=SUM+Y
    END IF
  END DO
  WRITE(*,*) 'This is the sum of the positive cubes:',SUM
END
```

#### Execution results

Running the program yields the following results:

```
$ a.out
5
37
22
-4
19
6
  This is the sum of the positive cubes: 68376.00000
```

---

### Example 2 - valid C routine source file

This is an example of a valid C routine source file used to execute Fortran test subroutines.

```

/*
 * *****
 * This is a main function that creates threads to execute the Fortran
 * test subroutines.
 * *****
 */
#include <pthread.h>
#include <stdio.h>
#include <errno.h>

extern char *sys_errlist[];
extern char *optarg;
extern int optind;

static char *prog_name;

#define MAX_NUM_THREADS 100

void *f_mt_exec(void *);
void f_pre_mt_exec(void);
void f_post_mt_exec(int *);

void
usage(void)
{
    fprintf(stderr, "Usage: %s -t number_of_threads.\n", prog_name);
    exit(-1);
}

main(int argc, char *argv[])
{
    int i, c, rc;
    int num_of_threads, n[MAX_NUM_THREADS];
    char *num_of_threads_p;
    pthread_attr_t attr;
    pthread_t tid[MAX_NUM_THREADS];

    prog_name = argv[0];
    while ((c = getopt(argc, argv, "t")) != EOF)
    {
        switch (c)
        {
            case 't':
                break;

            default:
                usage();
                break;
        }
    }

    argc -= optind;
    argv += optind;
    if (argc < 1)
    {
        usage();
    }

    num_of_threads_p = argv[0];
    if ((num_of_threads = atoi(num_of_threads_p)) == 0)
    {
        fprintf(stderr,
            "%s: Invalid number of threads to be created <\n", prog_name,
            num_of_threads_p);
        exit(1);
    }
    else if (num_of_threads > MAX_NUM_THREADS)
    {

```

```

        fprintf(stderr,
               "%s: Cannot create more than 100 threads.\n", prog_name);
        exit(1);
    }
    pthread_attr_init(&attr);
    pthread_attr_setdetachstate(&attr, PTHREAD_CREATE_UNDETACHED);

    /* *****
     * Execute the Fortran subroutine that prepares for multithreaded
     * execution.
     * *****
     */
    f_pre_mt_exec();

    for (i = 0; i < num_of_threads; i++)
    {
        n[i] = i;
        rc = pthread_create(&tid[i], &attr, f_mt_exec, (void *)&n[i]);
        if (rc != 0)
        {
            fprintf(stderr, "Failed to create thread %d.\n", i);
            fprintf(stderr, "Error is %s\n", sys_errlist[rc]);
            exit(1);
        }
    }
    /* The attribute is no longer needed after threads are created. */
    pthread_attr_destroy(&attr);
    for (i = 0; i < num_of_threads; i++)
    {
        rc = pthread_join(tid[i], NULL);
        if (rc != 0)
        {
            fprintf(stderr, "Failed to join thread %d. \n", i);
            fprintf(stderr, "Error is %s\n", sys_errlist[rc]);
        }
    }
    /*
     * Execute the Fortran subroutine that does the check after
     * multithreaded execution.
     */
    f_post_mt_exec(&num_of_threads);

    exit(0);
}

```

```

! *****
! This test case tests the writing list-directed to a single external
! file by many threads.
! *****

```

```

subroutine f_pre_mt_exec()
integer array(1000)
common /x/ array

do i = 1, 1000
    array(i) = i
end do

open(10, file="fun10.out", form="formatted", status="replace")
end

subroutine f_post_mt_exec(number_of_threads)
integer array(1000), array1(1000)
common /x/ array

close(10)
open(10, file="fun10.out", form="formatted")

```

```

do j = 1, number_of_threads
  read(10, *) array1

  do i = 1, 1000
    if (array1(i) /= array(i)) then
      print *, "Result is wrong."
      stop
    endif
  end do
end do
close(10, status="delete")
print *, "Normal ending."
end

subroutine f_mt_exec(thread_number)
integer thread_number
integer array(1000)
common /x/ array

write(10, *) array
end

```

---

### Example 3 - valid Fortran SMP source file

This is an example of a valid Fortran SMP source file used to calculate the value of pi.

```

!*****
!* This example uses a PARALLEL construct and a DO construct *
!* to calculate the value of pi. *
!*****
program compute_pi
integer n, i
real*8 w, x, pi, f, a
f(a) = 4.d0 / (1.d0 + a*a) !! function to integrate

pi = 0.0d0
!$OMP PARALLEL private(x, w, n), shared(pi)
n = 10000 !! number of intervals
w = 1.0d0/n !! calculate the interval size
!$OMP DO reduction(+: pi)
do i = 1, n
  x = w * (i - 0.5d0)
  pi = pi + f(x)
enddo
!$OMP END DO
!$OMP END PARALLEL
print *, "Computed pi = ", pi
end

```

---

### Example 4 - invalid Fortran SMP source file

This is an example of an invalid Fortran SMP source file.

```

!*****
!* In this example, fort_sub is invoked by multiple threads. *
!* *
!* This example is not valid because *
!* fort_sub and another_sub both declare /block/ to be *
!* THREADPRIVATE. They intend to share the common block, but *
!* they are executed via different threads. *
!* *
!* To "fix" this problem, one of the following approaches can *
!* be taken: *
!* (1) The code for another_sub should be brought into the loop.*
!* (2) "j" should be passed as an argument to another_sub, and *

```



```

!*      the declaration for /block/ should be removed from      *
!*      another_sub.   *
!* (3) The loop should be marked as "do not parallelize" by    *
!*      using the directive "!$OMP PARALLEL DO IF(.FALSE.)".    *
!*****

subroutine fort_sub()

  common /block/ j
  integer :: j
  !$OMP THREADPRIVATE(/block/)      ! Each thread executing fort_sub
                                     ! obtains its own copy of /block/.

  integer a(10)

  ...
  !$OMP PARALLEL DO
  do index = 1,10
    call another_sub(a(i))
  enddo
  ...

end subroutine fort_sub

subroutine another_sub(aa)      ! Multiple threads are used to
  integer aa                    ! execute another_sub.
  common /block/ j             ! Each thread obtains a new copy
  integer :: j                  ! of the common block /block/.
  !$OMP THREADPRIVATE(/block/)

  aa = j                        ! The value of "j" is undefined.
end subroutine another_sub

```

---

## Programming examples using the Pthreads library module

These examples demonstrate the use of the Pthreads library module.

```

!*****
!* Example 5 : Create a thread with Round_Robin scheduling policy.*
!* For simplicity, we do not show any codes for error checking,  *
!* which would be necessary in a real program.                    *
!*****

use, intrinsic::f_pthread
integer(4) ret_val
type(f_pthread_attr_t) attr
type(f_pthread_t) thr

ret_val = f_pthread_attr_init(attr)
ret_val = f_pthread_attr_setschedpolicy(attr, SCHED_RR)
ret_val = f_pthread_attr_setinheritsched(attr, PTHREAD_EXPLICIT_SCHED)
ret_val = f_pthread_create(thr, attr, FLAG_DEFAULT, ent, integer_arg)
ret_val = f_pthread_attr_destroy(attr)
.....

```

Before you can manipulate a pthread attribute object, you need to create and initialize it. The appropriate interfaces must be called to manipulate the attribute objects. A call to **f\_pthread\_attr\_setschedpolicy** sets the scheduling policy attribute to Round\_Robin. Note that this does not affect newly created threads that inherit the scheduling property from the creating thread. For these threads, we explicitly call **f\_pthread\_attr\_setinheritsched** to override the default inheritance attribute. The rest of the code is self-explanatory.

```

!*****
!* Example 6 : Thread safety                                     *
!* In this example, we show that thread safety can be achieved  *
!* by using the push-pop cleanup stack for each thread. We     *
!* assume that the thread is in deferred cancellability-enabled *
!*****

```

```

!* state. This means that any thread-cancel requests will be      *
!* put on hold until a cancellation point is encountered.          *
!* Note that f_pthread_cond_wait provides a                        *
!* cancellation point.   *
!*****
use, intrinsic::f_pthread
integer(4) ret_val
type(f_pthread_mutex_t) mutex
type(f_pthread_cond_t) cond
pointer(p, byte)
! Initialize mutex and condition variables before using them.
! For global variables this should be done in a module, so that they
! can be used by all threads. If they are local, other threads
! will not see them. Furthermore, they must be managed carefully
! (for example, destroy them before returning, to avoid dangling and
! undefined objects).
mutex = PTHREAD_MUTEX_INITIALIZER
cond = PTHREAD_COND_INITIALIZER

.....
! Doing something

.....

! This thread needs to allocate some memory area used to
! synchronize with other threads. However, when it waits on a
! condition variable, this thread may be canceled by another
! thread. The allocated memory may be lost if no measures are
! taken in advance. This will cause memory leakage.

ret_val = f_pthread_mutex_lock(mutex)
p = malloc(%val(4096))

! Check condition. If it is not true, wait for it.
! This should be a loop.

! Since memory has been allocated, cleanup must be registered
! for safety during condition waiting.

ret_val = f_pthread_cleanup_push(mycleanup, FLAG_DEFAULT, p)
ret_val = f_pthread_cond_wait(cond, mutex)

! If this thread returns from condition waiting, the cleanup
! should be de-registered.

call f_pthread_cleanup_pop(0)      ! not execute
ret_val = f_pthread_mutex_unlock(mutex)

! This thread will take care of p for the rest of its life.
.....

! mycleanup looks like:

subroutine mycleanup(passed_in)
  pointer(passed_in, byte)
  external free

  call free(%val(passed_in))
end subroutine mycleanup

```

---

## Notices

Programming interfaces: Intended programming interfaces allow the customer to write programs to obtain the services of IBM XL Fortran for AIX.

This information was developed for products and services offered in the U.S.A. IBM may not offer the products, services, or features discussed in this document in other countries. Consult your local IBM representative for information on the products and services currently available in your area. Any reference to an IBM product, program, or service is not intended to state or imply that only that IBM product, program, or service may be used. Any functionally equivalent product, program, or service that does not infringe any IBM intellectual property right may be used instead. However, it is the user's responsibility to evaluate and verify the operation of any non-IBM product, program, or service.

IBM may have patents or pending patent applications covering subject matter described in this document. The furnishing of this document does not give you any license to these patents. You can send license inquiries, in writing, to:

IBM Director of Licensing  
IBM Corporation  
North Castle Drive, MD-NC119  
Armonk, NY 10504-1785  
U.S.A.

For license inquiries regarding double-byte (DBCS) information, contact the IBM Intellectual Property Department in your country or send inquiries, in writing, to:

Intellectual Property Licensing  
Legal and Intellectual Property Law  
IBM Japan, Ltd.  
19-21, Nihonbashi-Hakozakicho, Chuo-ku  
Tokyo 103-8510, Japan

**The following paragraph does not apply to the United Kingdom or any other country where such provisions are inconsistent with local law:**

INTERNATIONAL BUSINESS MACHINES CORPORATION PROVIDES THIS PUBLICATION "AS IS" WITHOUT WARRANTY OF ANY KIND, EITHER EXPRESS OR IMPLIED, INCLUDING, BUT NOT LIMITED TO, THE IMPLIED WARRANTIES OF NON-INFRINGEMENT, MERCHANTABILITY OR FITNESS FOR A PARTICULAR PURPOSE. Some states do not allow disclaimer of express or implied warranties in certain transactions, therefore, this statement may not apply to you.

This information could include technical inaccuracies or typographical errors. Changes are periodically made to the information herein; these changes will be incorporated in new editions of the publication. IBM may make improvements and/or changes in the product(s) and/or the program(s) described in this publication at any time without notice.

Any references in this information to non-IBM websites are provided for convenience only and do not in any manner serve as an endorsement of those

websites. The materials at those websites are not part of the materials for this IBM product and use of those websites is at your own risk.

IBM may use or distribute any of the information you supply in any way it believes appropriate without incurring any obligation to you.

Licensees of this program who want to have information about it for the purpose of enabling: (i) the exchange of information between independently created programs and other programs (including this one) and (ii) the mutual use of the information which has been exchanged, should contact:

Intellectual Property Dept. for Rational Software  
IBM Corporation  
5 Technology Park Drive  
Westford, MA 01886  
U.S.A.

Such information may be available, subject to appropriate terms and conditions, including in some cases, payment of a fee.

The licensed program described in this document and all licensed material available for it are provided by IBM under terms of the IBM Customer Agreement, IBM International Program License Agreement or any equivalent agreement between us.

Any performance data contained herein was determined in a controlled environment. Therefore, the results obtained in other operating environments may vary significantly. Some measurements may have been made on development-level systems and there is no guarantee that these measurements will be the same on generally available systems. Furthermore, some measurements may have been estimated through extrapolation. Actual results may vary. Users of this document should verify the applicable data for their specific environment.

Information concerning non-IBM products was obtained from the suppliers of those products, their published announcements or other publicly available sources. IBM has not tested those products and cannot confirm the accuracy of performance, compatibility or any other claims related to non-IBM products. Questions on the capabilities of non-IBM products should be addressed to the suppliers of those products.

All statements regarding IBM's future direction or intent are subject to change or withdrawal without notice, and represent goals and objectives only.

This information contains examples of data and reports used in daily business operations. To illustrate them as completely as possible, the examples include the names of individuals, companies, brands, and products. All of these names are fictitious and any similarity to the names and addresses used by an actual business enterprise is entirely coincidental.

#### COPYRIGHT LICENSE:

This information contains sample application programs in source language, which illustrates programming techniques on various operating platforms. You may copy, modify, and distribute these sample programs in any form without payment to IBM, for the purposes of developing, using, marketing or distributing application programs conforming to the application programming interface for the operating

platform for which the sample programs are written. These examples have not been thoroughly tested under all conditions. IBM, therefore, cannot guarantee or imply reliability, serviceability, or function of these programs. The sample programs are provided "AS IS", without warranty of any kind. IBM shall not be liable for any damages arising out of your use of the sample programs.

Each copy or any portion of these sample programs or any derivative work, must include a copyright notice as follows:

© (your company name) (year). Portions of this code are derived from IBM Corp. Sample Programs. © Copyright IBM Corp. 1998, 2015.

This software and documentation are based in part on the Fourth Berkeley Software Distribution under license from the Regents of the University of California. We acknowledge the following institution for its role in this product's development: the Electrical Engineering and Computer Sciences Department at the Berkeley campus.

#### PRIVACY POLICY CONSIDERATIONS:

IBM Software products, including software as a service solutions, ("Software Offerings") may use cookies or other technologies to collect product usage information, to help improve the end user experience, or to tailor interactions with the end user, or for other purposes. In many cases no personally identifiable information is collected by the Software Offerings. Some of our Software Offerings can help enable you to collect personally identifiable information. If this Software Offering uses cookies to collect personally identifiable information, specific information about this offering's use of cookies is set forth below.

This Software Offering does not use cookies or other technologies to collect personally identifiable information.

If the configurations deployed for this Software Offering provide you as customer the ability to collect personally identifiable information from end users via cookies and other technologies, you should seek your own legal advice about any laws applicable to such data collection, including any requirements for notice and consent.

For more information about the use of various technologies, including cookies, for these purposes, see IBM's Privacy Policy at <http://www.ibm.com/privacy> and IBM's Online Privacy Statement at <http://www.ibm.com/privacy/details> in the section entitled "Cookies, Web Beacons and Other Technologies," and the "IBM Software Products and Software-as-a-Service Privacy Statement" at <http://www.ibm.com/software/info/product-privacy>.

---

## Trademarks

IBM, the IBM logo, and [ibm.com](http://www.ibm.com) are trademarks or registered trademarks of International Business Machines Corp., registered in many jurisdictions worldwide. Other product and service names might be trademarks of IBM or other companies. A current list of IBM trademarks is available on the web at "Copyright and trademark information" at <http://www.ibm.com/legal/copytrade.shtml>.

Adobe and the Adobe logo are either registered trademarks or trademarks of Adobe Systems Incorporated in the United States, other countries, or both.

Linux is a registered trademark of Linus Torvalds in the United States, other countries, or both.

UNIX is a registered trademark of The Open Group in the United States and other countries.

# Index

## Special characters

`_OPENMP` C preprocessor macro 89  
-O0 3  
-O2 3  
-O3 5  
    trade-offs 6  
-O4 7  
    trade-offs 7  
-O5 8  
    trade-offs 8  
-qarch 40  
-qcache 7, 42  
-qcompact  
    code size 55  
-qfloat compiler option 319  
    fltint suboption 320  
    hsflt suboption 320  
    hssngl suboption 320  
    nans suboption 327  
    nomaf suboption 319  
    rsqrt suboption 320  
-qflttrap compiler option 321  
-qfunctrace 32  
-qfunctrace\_xlf\_enter 32  
-qfunctrace\_xlf\_exit 32  
-qfunctrace\_xlf\_catch 32  
-qinline inlining  
    code size 54  
-qipa 7  
    IPA process 7  
-qlistfmt 30  
-qnofunctrace 32  
-qpdf1, -qpdf2 15  
-qposition 294  
-qsigtrap 323  
-qstrict 6  
-qtune 42  
/tmp directory 298  
\* length specifiers (FORTRAN 77 extension) 331  
%REF functions 273  
%VAL functions 273

## Numerics

64-bit data types (FORTRAN 77 extension) 331

## A

advanced optimization 4  
AIX commands  
    rmss 54  
aliasing 49  
arguments  
    passing between languages 268, 269  
    passing by reference or by value 273  
array initialization  
    code size 54

arrays  
    passing between languages 272  
assembler  
    low-level linkage conventions 276  
ATOMIC 107

## B

BARRIER 113  
basic example, described xii  
basic optimization 2  
bitwise-identical floating-point  
    results 319  
block  
    cyclic scheduling 181  
blocked special files, interaction of XL  
    Fortran I/O with 295  
buffers, flushing 297  
BYTE data type (FORTRAN 77 extension) 331

## C

C language and interlanguage calls 265, 268  
C++ and Fortran in same program 267  
calling by reference or value 273  
calling non-Fortran procedures 265  
CASE construct  
    code size 56  
character data, passing between  
    languages 271  
character special files, interaction of XL  
    Fortran I/O with 295  
character-count edit descriptor  
    (FORTRAN 77 extension) 331  
check\_fpscr.f sample file 326  
chunk  
    SCHEDULE directive and 135  
code size 53  
    -qcompact 55  
    -qinline inlining 54  
    array initialization 54  
    blocking 53  
    CASE constructs 56  
    computed GOTOS 56  
    dynamic linking 56  
    high activity areas 55  
    page faults 55  
    rmss 54  
    static linking 56  
    steps for reduction 54  
common blocks  
    in data scope attribute clauses 160  
compiler-friendly techniques 65  
Compiler-friendly techniques  
    aliasing 66  
    arrays 66  
    choosing appropriate variable  
        sizes 67

Compiler-friendly techniques (*continued*)  
    compiler invocations 65  
    floating-point precision 67  
    PERMUTATION 66  
    pointers 66  
    SUBMODULE 67  
    submodules 67  
    variables 66  
    WHERE constructs 66  
computed GOTO  
    code size 56  
conditional vector merge intrinsic  
    functions (FORTRAN 77 extension) 331  
control and status register for floating  
    point 325  
controlling optimization  
    transformations 46  
COPYIN clause 163  
core file 323, 324  
CRAY functions (FORTRAN 77 extension)  
    conditional vector merge  
        intrinsic 331  
    date and time service and utility  
        functions 331  
CRAY pointer (FORTRAN 77 extension),  
    XL Fortran equivalent 331  
CRITICAL 114  
CVMGx intrinsic functions (FORTRAN 77 extension) 331

## D

data scope attribute clauses  
    COPYIN clause 163  
    discussion 160  
data scoping rules 158  
data sharing attribute rules 158  
data striping 299  
data types in Fortran, C 269  
date and time functions (FORTRAN 77 extension) 331  
debugging 59  
delays runtime option 95  
deprecated SMP directive 106  
directive clauses, global rules 160  
directives 106  
    DO SERIAL 119  
    END MASTER 122  
    END ORDERED 124  
    END PARALLEL 126  
    END PARALLEL DO 128  
    END PARALLEL SECTIONS 132  
    END PARALLEL WORKSHARE 134  
    END SECTIONS 138  
    FLUSH 120  
    MASTER 122  
    ORDERED 124  
    PARALLEL 126  
    PARALLEL DO 128  
    PARALLEL SECTIONS 132

directives (*continued*)  
 PARALLEL WORKSHARE 134  
 SCHEDULE 135  
 SECTIONS 138  
 SINGLE / END SINGLE 141  
 THREADLOCAL 148  
 THREADPRIVATE 150  
 WORKSHARE 156  
 Directives  
 ATOMIC 107  
 BARRIER 113  
 CRITICAL 114  
 DO (worksharing) 116  
 END CRITICAL 114  
 END DO (worksharing) 116  
 DO (worksharing) 116  
 DO SERIAL compiler directive 119  
 double-precision values 312, 314  
 dynamic linking  
 code size 56

## E

enable suboption of -qfltrap 324  
 enabling MASS 10  
 enabling VMX or VSX 10  
 END CRITICAL 114  
 END DO (worksharing) 116  
 END MASTER compiler directive 122  
 END ORDERED compiler directive 124  
 END PARALLEL compiler directive 126  
 END PARALLEL DO compiler  
 directive 128  
 END PARALLEL SECTIONS compiler  
 directive 132  
 END PARALLEL WORKSHARE compiler  
 directive 134  
 END SECTIONS compiler directive 138  
 environment variables  
 OpenMP  
 OMP\_DISPLAY\_ENV 97  
 OMP\_DYNAMIC 98  
 OMP\_NESTED 99  
 OMP\_NUM\_THREADS 99  
 OMP\_PROC\_BIND 101  
 OMP\_SCHEDULE 102  
 OMP\_STACKSIZE 102  
 OMP\_THREAD\_LIMIT 103  
 OMP\_WAIT\_POLICY 104  
 runtime  
 XLSMPOPTS 90  
 exception handling 313  
 for floating point 321  
 installing an exception handler 323  
 execution environment routines  
 OpenMP 184  
 explicit interfaces 275  
 extended-precision values 315  
 extensions to FORTRAN 77, list of  
 common ones 331

## F

f\_maketime function 210  
 f\_pthread 206  
 f\_pthread\_attr\_destroy function 210

f\_pthread\_attr\_getdetachstate  
 function 211  
 f\_pthread\_attr\_getguardsize  
 function 211  
 f\_pthread\_attr\_getinheritsched  
 function 212  
 f\_pthread\_attr\_getschedparam  
 function 213  
 f\_pthread\_attr\_getschedpolicy  
 function 213  
 f\_pthread\_attr\_getscope function 214  
 f\_pthread\_attr\_getstackaddr  
 function 215  
 f\_pthread\_attr\_getstacksize function 215  
 f\_pthread\_attr\_init function 216  
 f\_pthread\_attr\_setdetachstate  
 function 216  
 f\_pthread\_attr\_setguardsize 217  
 f\_pthread\_attr\_setinheritsched  
 function 218  
 f\_pthread\_attr\_setschedparam  
 function 219  
 f\_pthread\_attr\_setschedpolicy  
 function 219  
 f\_pthread\_attr\_setscope function 220  
 f\_pthread\_attr\_setstackaddr function 221  
 f\_pthread\_attr\_setstacksize function 221  
 f\_pthread\_attr\_t function 222  
 f\_pthread\_cancel function 222  
 f\_pthread\_cleanup\_pop function 223  
 f\_pthread\_cleanup\_push function 223  
 f\_pthread\_cond\_broadcast function 225  
 f\_pthread\_cond\_destroy function 225  
 f\_pthread\_cond\_init function 226  
 f\_pthread\_cond\_signal function 226  
 f\_pthread\_cond\_t function 227  
 f\_pthread\_cond\_timedwait function 227  
 f\_pthread\_cond\_wait function 228  
 f\_pthread\_condattr\_destroy function 228  
 f\_pthread\_condattr\_getpshared  
 function 229  
 f\_pthread\_condattr\_init function 230  
 f\_pthread\_condattr\_setpshared  
 function 230  
 f\_pthread\_condattr\_t function 231  
 f\_pthread\_create function 231  
 f\_pthread\_detach function 233  
 f\_pthread\_equal function 233  
 f\_pthread\_exit function 234  
 f\_pthread\_getconcurrency function 234  
 f\_pthread\_getschedparam function 235  
 f\_pthread\_getspecific function 235  
 f\_pthread\_join function 236  
 f\_pthread\_key\_create function 237  
 f\_pthread\_key\_delete function 237  
 f\_pthread\_key\_t 238  
 f\_pthread\_kill function 238  
 f\_pthread\_mutex\_destroy function 239  
 f\_pthread\_mutex\_getprioceiling  
 function 239  
 f\_pthread\_mutex\_init function 240  
 f\_pthread\_mutex\_lock function 241  
 f\_pthread\_mutex\_setprioceiling  
 function 241  
 f\_pthread\_mutex\_t 242  
 f\_pthread\_mutex\_trylock function 242  
 f\_pthread\_mutex\_unlock function 243

f\_pthread\_mutexattr\_destroy  
 function 243  
 f\_pthread\_mutexattr\_getprioceiling  
 function 244  
 f\_pthread\_mutexattr\_getprotocol  
 function 244  
 f\_pthread\_mutexattr\_getpshared  
 function 245  
 f\_pthread\_mutexattr\_gettype  
 function 245  
 f\_pthread\_mutexattr\_init function 246  
 f\_pthread\_mutexattr\_setprioceiling  
 function 247  
 f\_pthread\_mutexattr\_setprotocol  
 function 247  
 f\_pthread\_mutexattr\_setpshared  
 function 248  
 f\_pthread\_mutexattr\_settype  
 function 249  
 f\_pthread\_mutexattr\_t 250  
 f\_pthread\_once function 250  
 f\_pthread\_once\_t 250  
 f\_pthread\_rwlock\_destroy function 251  
 f\_pthread\_rwlock\_init function 251  
 f\_pthread\_rwlock\_rdlock function 252  
 f\_pthread\_rwlock\_t function 253  
 f\_pthread\_rwlock\_tryrdlock  
 function 253  
 f\_pthread\_rwlock\_trywrlock  
 function 254  
 f\_pthread\_rwlock\_unlock function 254  
 f\_pthread\_rwlock\_wrlock function 255  
 f\_pthread\_rwlockattr\_destroy  
 function 256  
 f\_pthread\_rwlockattr\_getpshared  
 function 256  
 f\_pthread\_rwlockattr\_init function 257  
 f\_pthread\_rwlockattr\_setpshared  
 function 257  
 f\_pthread\_rwlockattr\_t function 258  
 f\_pthread\_self function 258  
 f\_pthread\_setcancelstate function 259  
 f\_pthread\_setcanceltype function 259  
 f\_pthread\_setconcurrency function 260  
 f\_pthread\_setschedparam function 261  
 f\_pthread\_setspecific function 262  
 f\_pthread\_t function 262  
 f\_pthread\_testcancel function 263  
 f\_sched\_param function 263  
 f\_sched\_yield function 263  
 f\_timespec function 264  
 f77 command and file positioning 294  
 fhandler.F sample file 326  
 file positioning 294  
 files  
 I/O formats 291  
 names 292  
 permissions 296  
 floating-point  
 exceptions 321  
 processing 311  
 optimizing 320  
 floating-point optimization 43  
 floating-point status and control  
 register 325  
 FLTRAP @PROCESS directive 321



flttrap\_handler.c and flttrap\_test.f sample files 326  
 FLUSH compiler directive 120  
 flushing I/O buffers 297  
 formats, file 291  
 fort.\* default file names 293, 298  
 FORTRAN 77 extensions, list of common ones 331  
 fp\_trap libc routine 322  
 fpdt.h and fpdc.h include files 316  
 fpgets and fpsets service and utility subroutines 325  
 fpscr register 325  
 fpstat array 325  
 functions  
     linkage convention for calls 287  
     return values 275  
 FUNCTRACE\_XLF\_CATCH 32  
 FUNCTRACE\_XLF\_ENTER 32  
 FUNCTRACE\_XLF\_EXIT 32

## G

get\_round\_mode procedure 316  
 GETENV intrinsic procedure 292

## H

high-order transformation 9  
 HOT 9

## I

IEEE arithmetic 311  
 implicitly connected files 293  
 infinity values 312  
 initial file position 294  
 Inlining 50  
 input/output 311  
     increasing throughput with data striping 299  
     redirection 295  
     XL Fortran implementation details 291  
 instruction group support by architecture 40  
 integer POINTER (FORTRAN 77 extension) 331  
 interlanguage calls 265, 273  
     arrays 272  
     C++ 267  
     character types 271  
     corresponding data types 269  
     input and output 266  
     low-level linkage conventions 276  
     pointers 273  
 IPA 11  
     levels 14  
     suboptions 14  
     with C and C++ 15

## L

libmass library 72  
 libmassv library 74

library  
     MASS 71  
     scalar 72  
     vector 74  
 links, interaction of XL Fortran I/O with 295  
 lock routines  
     OpenMP 184  
 logical volumes, I/O operations on 299  
 long variable names (FORTRAN 77 extension) 331  
 long vectorization 10  
 loop optimization 9  
 lower case (FORTRAN 77 extension) 331

## M

macro, \_OPENMP C preprocessor 89  
 main, restriction on use as a Fortran name 265  
 MASS libraries 71  
     scalar functions 72  
     vector functions 74  
 MASTER compiler directive 122  
 mergepdf 15  
 migrating from other systems 329  
 minus infinity, representation of 312  
 mixing integers and logicals (FORTRAN 77 extension) 331  
 mklv command 300  
 module procedures, external names corresponding to 265

## N

naming conventions for external names 265  
 NaN values and infinities 312  
 negative infinity, representation of 312  
 NOFUNCTRACE 32  
 null-terminated strings, passing to C functions 271

## O

omp\_destory\_nest\_lock OpenMP nestable lock routine 186  
 omp\_destroy\_lock OpenMP lock routine 185  
 OMP\_DISPLAY\_ENV environment variable 97  
 OMP\_DYNAMIC environment variable 98  
 omp\_get\_active\_level OpenMP function 187  
 omp\_get\_ancestor\_thread\_num OpenMP function 187  
 omp\_get\_dynamic execution environment routine 187  
 omp\_get\_level OpenMP function 188  
 omp\_get\_max\_active\_levels OpenMP function 188  
 omp\_get\_max\_threads execution environment routine 189  
 omp\_get\_nested execution environment routine 189

omp\_get\_num\_procs execution environment routine 190  
 omp\_get\_num\_threads execution environment routine 190  
 omp\_get\_schedule OpenMP schedule routine 191  
 omp\_get\_team\_size OpenMP function 192  
 omp\_get\_thread\_limit OpenMP function 192  
 omp\_get\_thread\_num execution environment routine 193  
 omp\_get\_wtick OpenMP timing routine 194  
 omp\_get\_wtime OpenMP timing routine 194  
 omp\_in\_final execution environment routine 195  
 omp\_in\_parallel execution environment routine 195  
 omp\_init\_lock lock routine 196  
 omp\_init\_nest\_lock OpenMP nestable lock routine 197  
 OMP\_NESTED environment variable 99  
 OMP\_NUM\_THREADS environment variable 99  
 OMP\_PROC\_BIND environment variable 101  
 OMP\_SCHEDULE environment variable 102  
 omp\_set\_dynamic execution environment routine 198  
 omp\_set\_lock lock routine 199  
 omp\_set\_max\_active\_levels subroutine 200  
 omp\_set\_nest\_lock nestable lock routine 201  
 omp\_set\_nested execution environment routine 200  
 omp\_set\_num\_threads execution environment routine 202  
 omp\_set\_schedule routine 202  
 OMP\_STACKSIZE environment variable 102  
 omp\_test\_lock lock routine 203  
 omp\_test\_nest\_lock lock routine 204  
 OMP\_THREAD\_LIMIT environment variable 103  
 omp\_unset\_lock lock routine 205  
 omp\_unset\_nest\_lock lock routine 205  
 OMP\_WAIT\_POLICY environment variable 104  
 OpenMP  
     execution environment routines description 184  
     omp\_get\_dynamic 187  
     omp\_get\_max\_threads 189  
     omp\_get\_nested 189  
     omp\_get\_num\_procs 190  
     omp\_get\_num\_threads 190  
     omp\_get\_thread\_num 193  
     omp\_in\_final 195  
     omp\_in\_parallel 195  
     omp\_set\_dynamic 198  
     omp\_set\_nested 200  
     omp\_set\_num\_threads 202

## OpenMP (*continued*)

- function
  - omp\_get\_level 188
  - omp\_get\_max\_active\_levels 188
  - omp\_get\_thread\_limit 192
- get active level function
  - omp\_get\_active\_level 187
- get ancestor thread number function
  - omp\_get\_ancestor\_thread\_num 187
- get team size function
  - omp\_get\_team\_size 192
- lock routines
  - description 184
  - omp\_destroy\_lock 185
  - omp\_init\_lock 196
  - omp\_set\_lock 199
  - omp\_test\_lock 203
  - omp\_test\_nest\_lock 204
  - omp\_unset\_lock 205
  - omp\_unset\_nest\_lock 205
- nestable lock routines
  - omp\_destroy\_nest\_lock 186
  - omp\_init\_nest\_lock 197
  - omp\_set\_nest\_lock 201
- schedule routines
  - omp\_get\_schedule 191
  - omp\_set\_schedule 202
- subroutines
  - omp\_set\_max\_active\_levels 200
- timing routines
  - omp\_get\_wtick 194
  - omp\_get\_wtime 194

OpenMP environment variables 97, 98, 102, 104

optimization

- O0 3
- O2 3
- O3 5
- O4 7
- O5 8
- advanced 4
- and tuning 39
- basic 2
- debugging 59
- floating-point 43, 46
- for floating-point arithmetic 320
- loops 43, 46
- math functions 71
- options to avoid 48

optimization and tuning

- optimizing 1
- tuning 1

optimization trade-offs

- O3 6
- O4 7
- O5 8

optimization, diagnostics 30, 32

optimizing

- applications 1
- techniques 8

option driven tuning 43

OPTIONAL attribute 275

options for targeting your architecture 39

ORDERED compiler directive 124

## P

PARALLEL compiler directive
 

- discussion 126

PARALLEL DO compiler directive
 

- discussion 128
- SCHEDULE clause 128

PARALLEL SECTIONS compiler directive
 

- discussion 132

PARALLEL WORKSHARE compiler directive
 

- discussion 134

parthreshold runtime option 96

Pascal language and interlanguage calls 265

performance analysis 47

performance of floating-point arithmetic 320

performance tuning options 95

permissions of files 296

pipes, interaction of XL Fortran I/O with 295

plus infinity, representation of 312

pointers (integer POINTER) (FORTRAN 77 extension) 331

portability 330

porting to XL Fortran 329

POSITION @PROCESS directive 294

position of a file after an OPEN statement 294

positive infinity, representation of 312

postmortem.f sample file 326

preconnected files 293

procedures 32

profile-directed feedback (PDF) 15

profilefreq runtime option 96

profiling 15

providing your application
 

- characteristics 43

pseudo-devices, interaction of XL Fortran I/O with 295

Pthreads library module 337

Pthreads Library Module
 

- descriptions of functions in 206
- f\_maketime function 210
- f\_pthread\_attr\_destroy function 210
- f\_pthread\_attr\_getdetachstate function 211
- f\_pthread\_attr\_getguardsize function 211
- f\_pthread\_attr\_getinherited function 212
- f\_pthread\_attr\_getschedparam function 213
- f\_pthread\_attr\_getschedpolicy function 213
- f\_pthread\_attr\_getscope function 214
- f\_pthread\_attr\_getstackaddr 215
- f\_pthread\_attr\_getstacksize function 215
- f\_pthread\_attr\_init function 216
- f\_pthread\_attr\_setdetachstate function 216
- f\_pthread\_attr\_setguardsize function 217
- f\_pthread\_attr\_setinherited function 218

## Pthreads Library Module (*continued*)

- f\_pthread\_attr\_setschedparam function 219
- f\_pthread\_attr\_setschedpolicy function 219
- f\_pthread\_attr\_setscope function 220
- f\_pthread\_attr\_setstackaddr function 221
- f\_pthread\_attr\_setstacksize function 221
- f\_pthread\_attr\_t function 222
- f\_pthread\_cancel function 222
- f\_pthread\_cleanup\_pop function 223
- f\_pthread\_cleanup\_push function 223
- f\_pthread\_cond\_broadcast function 225
- f\_pthread\_cond\_destroy function 225
- f\_pthread\_cond\_init function 226
- f\_pthread\_cond\_signal function 226
- f\_pthread\_cond\_t function 227
- f\_pthread\_cond\_timedwait function 227
- f\_pthread\_cond\_wait function 228
- f\_pthread\_condattr\_destroy function 228
- f\_pthread\_condattr\_getpshared function 229
- f\_pthread\_condattr\_init function 230
- f\_pthread\_condattr\_setpshared function 230
- f\_pthread\_condattr\_t function 231
- f\_pthread\_create function 231
- f\_pthread\_detach function 233
- f\_pthread\_equal function 233
- f\_pthread\_exit function 234
- f\_pthread\_getconcurrency function 234
- f\_pthread\_getschedparam function 235
- f\_pthread\_getspecific function 235
- f\_pthread\_join function 236
- f\_pthread\_key\_create function 237
- f\_pthread\_key\_delete function 237
- f\_pthread\_key\_t 238
- f\_pthread\_kill function 238
- f\_pthread\_mutex\_destroy function 239
- f\_pthread\_mutex\_getprioceiling function 239
- f\_pthread\_mutex\_init function 240
- f\_pthread\_mutex\_lock function 241
- f\_pthread\_mutex\_setprioceiling function 241
- f\_pthread\_mutex\_t 242
- f\_pthread\_mutex\_trylock function 242
- f\_pthread\_mutex\_unlock function 243
- f\_pthread\_mutexattr\_destroy function 243
- f\_pthread\_mutexattr\_getprioceiling function 244
- f\_pthread\_mutexattr\_getprotocol function 244
- f\_pthread\_mutexattr\_getpshared function 245

Pthreads Library Module (*continued*)

- f\_thread\_mutexattr\_gettype function 245
- f\_thread\_mutexattr\_init function 246
- f\_thread\_mutexattr\_setprioceiling function 247
- f\_thread\_mutexattr\_setprotocol function 247
- f\_thread\_mutexattr\_setpshared function 248
- f\_thread\_mutexattr\_settype function 249
- f\_thread\_mutexattr\_t 250
- f\_thread\_once function 250
- f\_thread\_once\_t 250
- f\_thread\_rwlock\_destroy function 251
- f\_thread\_rwlock\_init function 251
- f\_thread\_rwlock\_rdlock function 252
- f\_thread\_rwlock\_t function 253
- f\_thread\_rwlock\_tryrdlock function 253
- f\_thread\_rwlock\_trywrlock function 254
- f\_thread\_rwlock\_unlock function 254
- f\_thread\_rwlock\_wrlock function 255
- f\_thread\_rwlockattr\_destroy function 256
- f\_thread\_rwlockattr\_getpshared function 256
- f\_thread\_rwlockattr\_init function 257
- f\_thread\_rwlockattr\_setpshared function 257
- f\_thread\_rwlockattr\_t function 258
- f\_thread\_self function 258
- f\_thread\_setcancelstate function 259
- f\_thread\_setcanceltype function 259
- f\_thread\_setchedparam function 261
- f\_thread\_setconcurrency function 260
- f\_thread\_setspecific function 262
- f\_thread\_t function 262
- f\_thread\_testcancel function 263
- f\_sched\_param function 263
- f\_sched\_yield function 263
- f\_timespec function 264

Pthreads Library, AIX 206

## Q

Q (character-count) edit descriptor (FORTRAN 77 extension) 331

quiet NaN 312

## R

raw logical volumes, I/O operations on 299

real arithmetic 311

REAL(16) values 315

REAL(4) and REAL(8) values 312, 314

record lengths 296

redirecting input/output 295

reference, passing arguments by 273

rounding 316

- rounding errors 318
- rounding mode 316, 319

## S

sample programs 333

- calling C functions from Fortran 269
- floating-point exception handling 326
- SMP 334

scalar MASS library 72

SCHEDULE clause, of PARALLEL DO directive 128

SCHEDULE compiler directive 135

- discussion 135

schedule runtime option 90

scheduling, block cyclic 181

scope

- data scope attribute clauses 160

scratch file directory 298

scratch\_vars runtime option 298

SECTIONS compiler directive 138

seqthreshold runtime option 96

short vectorization 10

showpdf 15

SIGFPE signal 321, 323

signal handling

- floating point 321
- installing an exception handler 323

signaling NaN 312, 327

SIGTRAP signal 321, 323

SINGLE / END SINGLE compiler directive 141

single-precision values 312, 314

SMP

- sample programs 334

SMP applications

- developing and running 104

special files, interaction of XL Fortran I/O with 295

spins runtime option 95

stack 278

stack runtime option 92

standard error, input, and output streams 293

star length specifiers 331

static linking

- code size 56

status and control register for floating point 325

stderr, stdin, and stdout streams 293

strings, passing to C functions 271

subprograms in other languages, calling 265, 268

Sun pointer (FORTRAN 77 extension), XL Fortran equivalent 331

symbolic links, interaction of XL Fortran I/O with 295

system Pthreads Library 206

## T

tape files, interaction of XL Fortran I/O with 295

tctl command 295

thread visible variables 120

thread-safing

- Pthreads Library Module 206

THREADLOCAL compiler directive 148

THREADPRIVATE compiler directive 150

throughput for I/O, increasing with data striping 299

time and date functions (FORTRAN 77 extension) 331

TOC overflow 23

- bbigtoc 24
- qminimaltoc 24
- qpqc=large 24
- performance 25

Trace/BPT trap 323

traceback listing 323

tracing 32

tuning 39

- qarch 40
- qcache 42
- qtune 42

controlling optimization transformations 46

instruction group support by architecture 40

option driven tuning 43

options to avoid 48

performance analysis 47

providing your application characteristics 43

typeless constants (FORTRAN 77 extension) 331

## U

unit\_vars runtime option 298

usrthds runtime option 92

## V

VALUE attribute 273

value, passing arguments by 273

vector MASS library 74

vectorization

- long 10
- short 10

## W

work-sharing constructs

- SECTIONS / END SECTIONS compiler directives 138
- SINGLE / END SINGLE compiler directives 141

WORKSHARE compiler directive 156

## X

xl\_ieee.F and xl\_ieee.c sample files 326

- xl\_sigdump exception handler 323
- xl\_trbk exception handler 323
- xl\_trbk\_test.f sample file 326
- xl\_trce exception handler 323
- xl\_trcedump exception handler 323
- xl command
  - and file positioning 294
- xl\_r command
  - and file positioning 294
- xl\_r7 command
  - and file positioning 294
- xl90 command
  - and file positioning 294
- xl90\_r command
  - and file positioning 294
- xl90\_r7 command
  - and file positioning 294
- XLFSCRATCH\_unit environment
  - variable 298
- XLFUNIT\_unit environment
  - variable 298
- XLSMPOPTS environment variable 90
- XML report schema 32

## Y

- yields runtime option 95





Product Number: 5765-J09; 5725-C74

Printed in USA

SC27-4246-02

